

N-96-01

United States  
Environmental Protection  
Agency  
Noise

Office of  
Noise Abatement and Control  
Washington, DC 20460

EPA 550/9-81-316  
Sept. 1981

II-A-148



EPA Report No. 550/9-81-316  
BBN Report No. 4782

## Sheetmetal Shop Noise Control at the Charlestown Naval Shipyard

R. Bruce, P. Jensen, C. Jokel, J. Lehr, and E. Wood

September 1981

Prepared for:  
Environmental Protection Agency

TECHNICAL REPORT DATA <i>(Please read instructions on the reverse before completing)</i>		
1. REPORT NO. EPA 550/9-81-316	2.	3. RECIPIENT'S ACCESSION NO.
4. TITLE AND SUBTITLE SHEET METAL SHOP NOISE CONTROL STUDY AT THE CHARLESTON NAVAL SHIPYARD	5. REPORT DATE September 1981	6. PERFORMING ORGANIZATION CODE
	7. AUTHOR(S) R. Bruce, P. Jensen, C. Joke1, J. Lehr, and E. Wood	
9. PERFORMING ORGANIZATION NAME AND ADDRESS Bolt Beranek and Newman Inc. 10 Moulton Street Cambridge, MA 02238	8. PERFORMING ORGANIZATION REPORT NO. BBN Report No. 4782	
	10. PROGRAM ELEMENT NO.	
12. SPONSORING AGENCY NAME AND ADDRESS Environmental Protection Agency, Washington, D.C. and Naval Sea Systems Command, Washington, D.C.	11. CONTRACT/GRANT NO. EPA Contract No. 68-015014 Task 29	
	13. TYPE OF REPORT AND PERIOD COVERED FINAL	
14. SPONSORING AGENCY CODE		
15. SUPPLEMENTARY NOTES		
16. ABSTRACT This report contains an evaluation of noise conditions in the sheet metal shop at the Charleston Naval Shipyard in Charleston, South Carolina (CNSY Shop 17). The study was performed during 1978. The evaluation is based on noise exposure data for full-time workers in Shop 17 and an analysis of noise emissions of the individual machine types used in the shop. Noise emission data are presented for the following equipment types:  <ul style="list-style-type: none"> <li>• Band saws</li> <li>• Friction saws</li> <li>• Pneumatic grinders</li> <li>• Electric routers</li> <li>• Square shears</li> <li>• Nibblers</li> <li>• Belt sanders</li> <li>• Punch presses (manual and numerically controlled)</li> <li>• Press brakes</li> <li>• Cutoff saws</li> <li>• Spot welders</li> <li>• Drill presses</li> <li>• Pneumatic drills</li> <li>• Electric drills</li> </ul>		
17. KEY WORDS AND DOCUMENT ANALYSIS		
a. DESCRIPTORS	b. IDENTIFIERS/OPEN ENDED TERMS	c. COBATI Field/Group
Shipyards noise Sheet metal Noise control		
18. DISTRIBUTION STATEMENT Unlimited	19. SECURITY CLASS (This Report) Unclassified	21. NO. OF PAGES 94
	20. SECURITY CLASS (This page) Unclassified	22. PRICE

United States  
Environmental Protection  
Agency

Office of  
Noise Abatement and Control  
Washington, DC 20460

EPA 550/9-81-316  
Sept. 1981

Noise

---

EPA Report No. 550/9-81-316  
BBN Report No. 4782

SHEETMETAL SHOP NOISE CONTROL AT THE CHARLESTON NAVAL SHIPYARD

R. Bruce, P. Jensen, C. Jokel, J. Lehr and Eric Wood

NAVSEA Contract No. N00024-77-C-4090  
Task No. SEC-6105-78-01  
EPA Contract No. 68-01-5014  
Task No. 29

Prepared by:  
Bolt Beranek and Newman Inc.  
50 Moulton Street  
Cambridge, Massachusetts 02238

This report has been approved by EPA for general availability. The contents of this report reflect the views of the contractor, who is responsible for the facts and the accuracy of the data presented herein, and do not necessarily reflect the official views or policy of EPA. This report does not constitute a standard, specification, or regulation.

PERMISSION IS GRANTED TO REPRODUCE THIS MATERIAL WITHOUT FURTHER CLEARANCE.

PREFACE

Under joint sponsorship of the Environmental Protection Agency's Office of Noise Abatement and Control (EPA) and the Naval Ship Engineering Center (NAVSEA), Bolt Beranek and Newman Inc. (BBN) evaluated the noise conditions in the sheet metal shop (CNSY Shop 17) at the Charleston Naval Shipyard in Charleston, South Carolina. BBN's draft report No. 3960 summarized the noise conditions in Shop 17 and presented noise control recommendations which, if installed, would reduce the risk of hearing loss to Shop 17 workers as a result of their exposure to noise inside Shop 17.

The Charleston Naval Shipyard Safety Office and Shop 17 personnel have been interested in quieting the shop for many years. Much progress had been made before the NAVSEA/EPA study and subsequent to the study additional work has been performed. This report summarizes the NAVSEA/EPA project and the work performed by personnel at Charleston subsequent to that project.

## EXECUTIVE SUMMARY

This report contains an evaluation of noise conditions in the sheet metal shop at the Charleston Naval Shipyard in Charleston, South Carolina (CNSY Shop 17). The study was performed during 1978. The evaluation is based on noise exposure data for full-time workers in Shop 17 and an analysis of noise emissions of the individual machine types used in the shop. Noise emission data are presented for the following equipment types:

- o Band saws
- o Friction saws
- o Pneumatic grinders
- o Electric routers
- o Square shears
- o Nibblers
- o Belt sanders
- o Punch presses (manual and numerically controlled)
- o Press brakes
- o Cutoff saws
- o Spot welders
- o Drill presses
- o Pneumatic drills
- o Electric drills.

The first seven machine types listed represent a noise hazard in Shop 17.. We recommend practical ways of obtaining noise reduction, along with estimates of expected costs and benefits for the recommended treatments. Four of the noise

hazards can be quieted so that they are no longer noise hazards, and the other three can be made significantly less hazardous. The anticipated benefit and associated hardware and installation costs (elaborated on in Sec. 4) are:

- o Band saw - approximate doubling of safe operational time at a cost of about \$1250 per saw
- o Friction saw - approximate doubling of safe operational time at a cost of about \$1300 per saw
- o Grinders - increase in safe operational time to about 330 min, virtually eliminating these machines as a noise hazard at a cost of about \$4750 for 100 tools
- o Router - approximate quadrupling of safe operational time at a cost of about \$1100
- o Shears - elimination of their noise hazard at a cost of about \$7550 for three shears
- o Nibbler - elimination of their noise hazard at a cost of about \$500
- o Sander - approximate seven-fold increase in safe operational time at a cost of about \$3000 per sander.

Total hardware and installation costs for the above treatments are \$19,450.

If these treatments are installed, the risk of hearing loss to Shop 17 workers as a result of the noise in the Shop will be reduced.

The Charleston Naval Shipyard has evaluated some of the recommendations presented and has, in several instances, been unable to incorporate them. The Shipyard efforts are discussed in this report.

This report also includes an appendix that reviews pertinent open-literature articles on noise emissions and noise reduction techniques applicable to the above-listed equipment categories.



## TABLE OF CONTENTS

	page
PREFACE.....	iv
EXECUTIVE SUMMARY.....	v
LIST OF FIGURES AND TABLES.....	ix
SECTION 1. INTRODUCTION.....	1
1.1 Overview of Shop Operations and Noise Environment.....	1
2. PROGRAM OVERVIEW.....	7
2.1 Program Objective.....	7
2.2 Measurements Performed.....	11
2.3 Additional Data Obtained.....	15
2.4 Synthesis of Information.....	15
3. ANALYSIS OF NOISE ASSOCIATED WITH INDIVIDUAL MACHINES.....	16
3.1 Band Saw S.N. 057962.....	16
3.2 Friction Saw S.N. 136-865.....	20
3.3 Punch Presses.....	21
3.4 Hand Tools.....	24
3.5 Square Shears.....	29
3.6 Nibblers.....	34
3.7 Belt Sander No. 141547.....	36
3.8 Abrasive Cutoff Saw.....	37
3.9 Noise Sources Outside the CNSY Sheet Metal Shop.....	39
3.10 Summary.....	40
4. EQUIPMENT DATA AND DATA ANALYSIS.....	42
5. SHIPYARD PROGRESS.....	75

## LIST OF FIGURES AND TABLES

		page
Figure	1. Shop layout.....	3
	2a. Continuous noise criterion.....	8
	2b. Impulsive noise criterion.....	10
	3. Saw noise barrier.....	18
	4. Grinding workstation booth.....	26
	5. Belt sander enclosure (detail of machine work areas.....)	38
	B.1 Octave band analysis of test's best nozzles that produce same force as metal pipe.....	B-7
	B.2 Dependence of enclosure attenuation on front access area.....	B-9
	B.3 Effect of punch impact velocity upon sound pressure level.....	B-9
	B.4 Effect of punch impact velocity upon sound pressure level.....	B-9
	B.5 Effect of Punch/die clearance upon sound pressure level.....	B-10
	B.6 Effect of angle of shear upon sound pressure level.....	B-10
	B.7 Sound pressure level vs shear area.....	B-10
	B.8 Effect of die shearing on sound level.....	B-13
	B.9 50-ton press with noise enclosure.....	B-27
	B.10 SPL, 30 in. from 50-ton press with and without cardboard enclosure.....	B-27
	B.11 The results of the acoustic measurements before (A) and after (B) the acoustical arrangements.....	B-29

TABLE OF CONTENTS (Cont.)

	page
Table 1.	Sound pressure levels of square shears.... 30
2.	Maximum allowable number of impulses for peak SPLs of shears..... 31
3.	Summary of recommendations and estimated cost and benefit by machine..... 41
B.1	Noise treatment options.....B-5
APPENDIX A.	DISCUSSION OF TECHNICAL TERMS.....A-1
APPENDIX B.	ABSTRACTS AND SUMMARIES OF ARTICLES AVAILABLE IN THE OPEN LITERATURE ON NOISE EMISSIONS AND CONTROL FOR EQUIPMENT SIMILAR TO THAT USED IN SHEET METAL SHOP 17.....B-1.
APPENDIX C.	DATA GATHERING AND DATA REDUCTION EQUIPMENT.....C-1

1. INTRODUCTION

The Environmental Protection Agency (EPA) and the Naval Sea Systems Command (NAVSEA) under an Interagency Agreement of 26 August 1977 jointly sponsored an investigation of the noise conditions in the sheet metal shop, Shop 17, of the Charleston Naval Shipyard (CNSY). The investigation, completed in December 1978, was performed under NAVSEA Contract No. N00024-77-C-4090, "Acoustic Engineering Support," Task No. SEC-6105-78-01, "Shipyard Noise Demonstration Project." BBN Report No. 3960 summarized this work. Subsequent to the BBN Report, CNSY implemented some of the recommendations but had difficulty implementing all of them. EPA, under Contract No. 68-01-5014, Task No. 29, sponsored a rewrite of Report No. 3960 to include a brief discussion of the Shipyard's effort to install the recommendations prepared by BBN. This report summarizes the BBN work and the Shipyard's efforts.

This section provides an overview of the CNSY sheet metal shop and its noise environment in 1978 and compares the probable impact of the noise environment on the hearing acuity of full-time shop workers. Section 2 describes the subject program in greater detail. Section 3 discusses the findings of the investigation, by machine, and Sec. 4 summarizes the data that formed the basis for the conclusions detailed in Sec. 3. Sec. 5 presents a brief summary of the Shipyard's progress.

1.1 Overview of Shop Operations and Noise Environment, 1978

In 1978, the operations in Shop 17 involved the fabrication of sheet metal components, including sheet metal furniture, ductwork, and fixtures. The fabrication of these

items requires the use of metal working equipment to cut, form, clean, or assemble components. This equipment is typical of that used in other industrial sheet metal shops. Specific items include:

- o Band saws
- o Friction saws
- o Punch presses (manual and numerically controlled)
- o Hand tools, including pneumatic grinders and drills and electric drills and routers
- o Square shears
- o Nibblers
- o Stand grinders and sanders
- o Cutoff saws
- o Press brakes
- o Spot welders
- o Drill presses

In the shop, the equipment is spread throughout an area approximately 100 ft x 400 ft. Figure 1 shows a layout of the shop as it was in 1978.

None of the approximately 60 full-time\* production workers in the shop is permanently assigned a work station. However, most workers spend the majority of each day at a single location and, unless on special assignment (when they work at a single machine), they use many of the machines in the shop as needed. Requirements for machine use vary from project to

\*About 120 other individuals work at least part-time in the shop. The rest of the time is spent working aboard ships. Therefore, this study concentrated only on the 60 full-time shop workers.

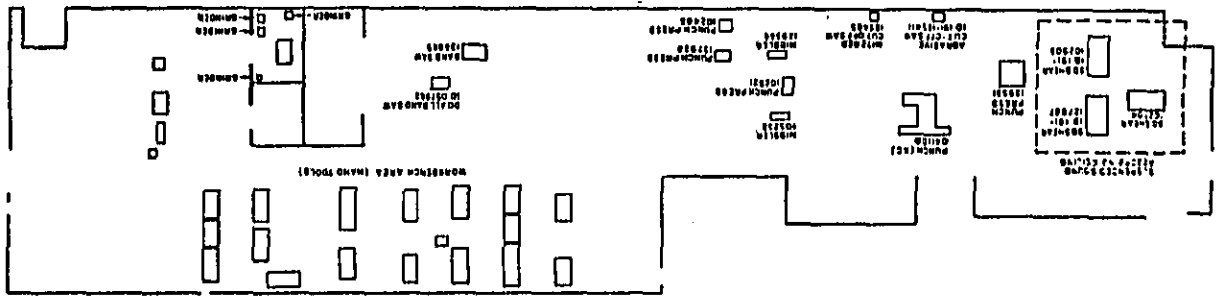

FIG. 1. SHOP LAYOUT

project, and the number and kind of projects assigned to the shop also change. Therefore, individual noise exposures in the shop vary from day to day.

The sound levels in the shop change constantly and are affected by the kind and number of projects on which work is being performed. The background sound level, set by the minimum amount of activity in the shop, ranges from about 70 to 75 dB(A) in the area around mid-shop (where most work is concentrated) to about 65 to 70 dB(A) in the less active ends of the shop. This background sound level, which does not constitute a threat to the health of any worker, seldom lasts for more than a few seconds anywhere in the shop. Sounds from individual operations cause an increase in sound level throughout the shop, depending on the type of operation occurring and the distance from the operation. The increase in sound level may be brief, as it would be if the operation were shearing, or it may last longer, as it would be if the operation were grinding or cutting.

Although most operations are readily audible throughout the shop, the sounds from those operations are considerably lower elsewhere than they are at the operator position. These distant sounds are more of an annoyance than they are a hazard.

Although background and distant sound levels associated with individual operations are relatively low, noise exposures at operator positions of individual machines may be high. Machines such as pneumatic hand tools or metal cutting saws produce sound levels at the operator's position between about 95 and 105 dB(A). Because the use of the various pieces of equipment is so variable, it is difficult to determine what kind of overall daily noise exposures occur in the shop.

To determine the range of possible noise exposures, noise dosimeters were worn by individual workers in each of the major working divisions of the shop. Dosimeter readings provide a measure of the "daily noise dose" incurred by the wearer - a measurement that accounts for both the intensity and duration of the sound imposed on the wearer's ears. As will be discussed in Sec. 2.2, the readings indicate that over half of the shop workers who wore dosimeters were exposed to average sound levels considered hazardous under instructions issued by the Department of Defense (DOD).

The readings do not preclude the possibility that noise exposures can occasionally be higher than those measured during this study. Therefore, further study was directed toward individual pieces of equipment, so that their relative contribution to individual noise exposures could be determined and so that machines requiring noise control could be identified.

Although the CNSY shop is similar to other shipyard sheet metal working facilities, it differs from industrial operations in several important respects:

- o At the shipyard shop, individual workers use a greater variety of equipment than they would in industrial shops, where techniques similar to those on a production line are employed.
- o At the shipyard shop, equipment is more spread out and in a larger space than is typical of industrial operations. As a consequence, workers in the CNSY shop are not as impacted by noise from their neighbors' activities as are workers in industrial operations.
- o The condition of equipment in the CNSY shop appear to be better than that in industry. The use factors of



be better than that in industry. The use factors of individual machines also appear lower in the CNSY shop than in industry. These observations indicate that machine wear and tear (and, hence, noise emissions) are lower at the shipyard for comparable equipment.

- o The working of sheet steel, a hard material, is generally noisier than the working of softer aluminum. Because some of the CNSY work is with aluminum, the CNSY shop noise exposures may be lower than for comparable industrial operations where aluminum is not worked.

These factors mean that the noise hazard assessment of individual pieces of equipment and the noise exposure assessment of sheet metal workers differs between shipyard and industrial sheet metal shops. In general, the exposure of those workers who work only in Shop 17 are likely to be less than would be found in many industrial shops.

## 2. PROGRAM OVERVIEW

This section describes and explains the work performed by BBN for the NAVSEA/EPA program.

### 2.1 Program Objective

Noise control rapidly becomes more difficult (and more expensive) as greater noise reductions are sought. It makes sense, then, to first identify an overall program objective so that each machine is treated in a cost-effective manner. An early step is to define quantitatively what would constitute an acceptable after-treatment noise environment.

For this program, the selected objective has two components, one for continuous (ongoing) sounds, the other for impulsive (high-intensity, short-lived) sounds. The objective for continuous sound stems from definitions of hazardous and safe noise exposures as stated in DOD Instruction Number 6055.3-June 1978. According to the DOD Instruction, the limits of safe exposure levels (L) for periods of less than 16 hours in any 24-hour period is found from:

$$T = 960 + \left[ \frac{(L-80)}{4} \right]$$

where T is the exposure time (in minutes). Figure 2a depicts the relationship between sound level and permissible exposure time. For example, sound levels must be less than 80 dB(A) for 16 hours of exposure - and no more than 84 dB(A) for 8 hours of exposure, 88 dB(A) for 4 hours, and so on.

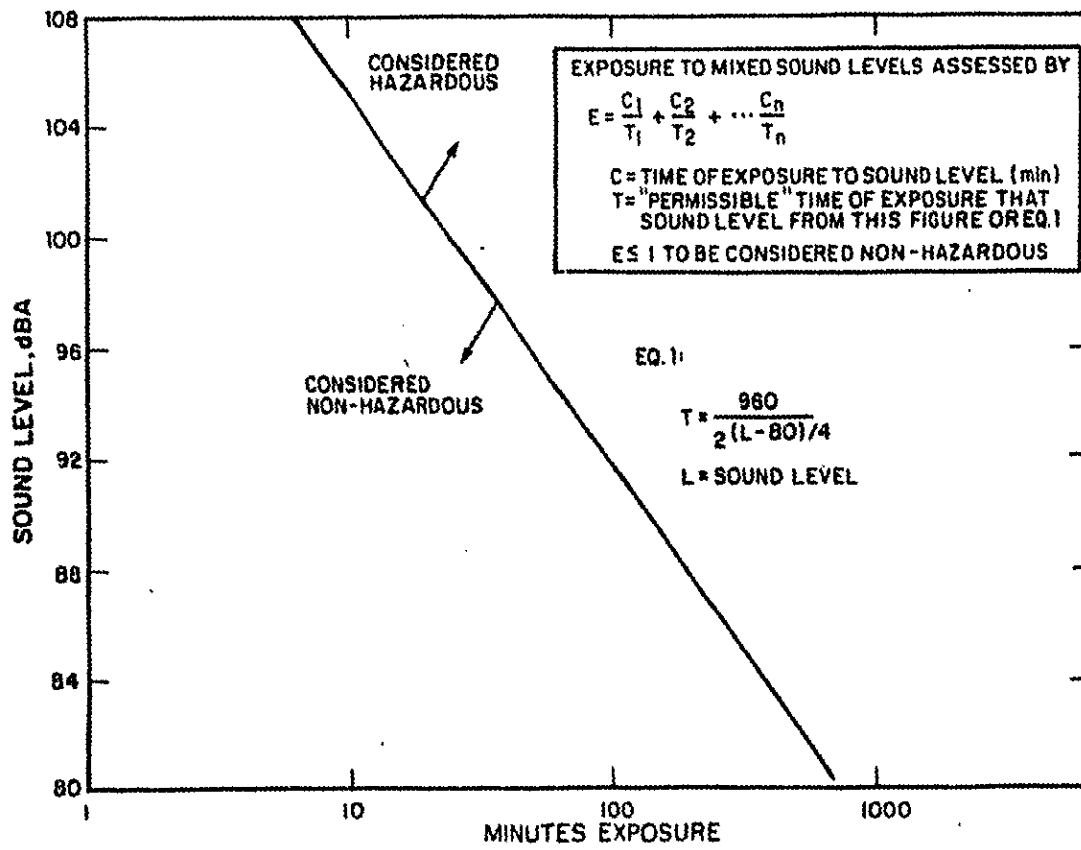

NO. 4782

Bolt Beranek and Newman

FIG. 2a. CONTINUOUS NOISE CRITERION.

To determine if an exposure made up of time-varying continuous sounds is hazardous, it must be broken down into the time spent at the various sound levels, and the exposure assessed according to the equation:

$$E = \frac{C_1}{T_1} + \frac{C_2}{T_2} + \frac{C_n}{T_n}$$

where C stands for the exposure time at a particular sound level and T stands for the permitted exposure time for that level, as read from Fig. 2a. To be acceptable, the sum of the individual C/T fractions must not exceed unity.

For impulsive sounds, the selected objective is that the maximum peak sound pressure level must not exceed 140 dB if up to 100 impulses occur daily, 130 dB if up to 1000 impulses occur, and 120 dB if 10,000 impulses occur. Intermediate values of maximum permitted peak sound pressure level can be read from Fig. 2b. The DOD instruction sheet limits impulse sounds to a peak sound pressure level of 140 dB. Thus, the objective in this study is more stringent than that used by DOD, and is chosen to be so on the basis that less is known about the hazardous effect of impulsive noises.

These criteria were selected with the understanding that there is no completely "safe" level of noise. The effect of noise exposure is an individual phenomenon, and some persons may be harmed by exposure to what would normally be considered

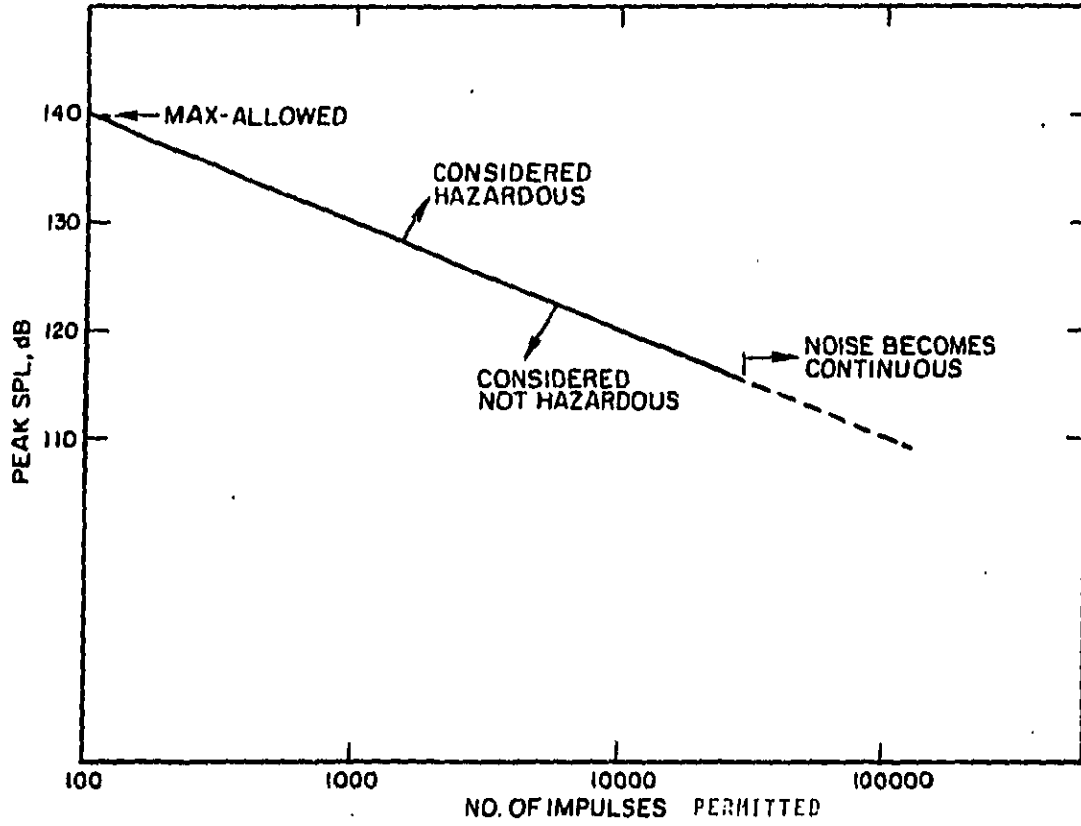

FIG. 2b. IMPULSIVE NOISE CRITERION.

innocuous sounds.\* The stated criteria are generally protective, and the consensus of the scientific community is that no more than 10% of a population exposed to sounds at these criteria levels would incur as much as a 5-dB loss of hearing averaged over the three frequency bands considered most important to speech communication after 10 years of exposure to the noise. Such a hearing loss would generally be considered minor.

## 2.2 Measurements Performed

Once the noise criteria were selected, BBN measured the present noise exposures. Two techniques were used: measuring noise exposures and measuring noise emissions.

### 2.2.1 Noise exposures

Noise exposures were measured directly as individual sheet metal mechanics wore noise dosimeters as they performed their normal duties. The dosimeters provided readings of the noise dose of the wearer, in accordance with the settings of the instruments, for the duration of time that the instrument was worn. The readings were adjusted later to account for time off for lunch breaks and to extrapolate to a full day's work. The dosimeters were used to provide a broad indication of noise exposures of the shop workers, rather than a detailed assessment.

\*An excellent summary of the topic has been compiled by J.C. Guignard for EPA/AMRL, "A Basis for Limiting Noise Exposure for Hearing Conservation," AMRL-TR-73-90; EPA 550-9-73-001-A, July 1973. Additional information is contained in EPA Report EPA-550-9-74-004, "Information on Levels of Environmental Noise Requisite to Protect Public Health and Welfare with an Adequate Margin of Safety," March 1974.

Since dosimeters incorporating the DOD criteria were not available, it was necessary to use other dosimeters and then infer from their readings the DOD exposures. Three dosimeter settings were used. They incorporated the OSHA criteria (90 dB(A) for an 8 hour day with a 5 dB increase for each halving of the exposure time), an OSHA proposed criteria (85 dB(A) for an 8 hour day with a 5 dB increase for each halving of the exposure time), and an EPA suggested criteria (85 dB(A) for an 8 hour day with a 3 dB increase for each halving of the exposure time). From these measurements and the trend resulting from the differences in the dosimeter readings, it is not unreasonable to expect that 75% (17 people) of those persons wearing dosimeters (23 people) would have been exposed to equivalent average sound levels of 84 dB(A) or higher.

#### 2.2.2 Noise emissions

For equipment emitting continuous noise at a steady-state sound level (an idling stand grinder, for example), direct readings of the sound level and octave-band sound pressure levels were obtained at the operator position and around each piece of equipment using hand-held precision sound level meters. For equipment emitting time-varying continuous noise (a grinding operation, for example), tape recordings were made at each operator position and around the equipment. Laboratory reduction of the tape recordings provided statistical information about the distribution of sound level values at the various measurement positions; these distributions were used to calculate values of noise emissions per hour of machine operation. The values on hourly noise emission were combined with data on machine usage to

determine the likelihood of a given machine causing or contributing to an excessive noise exposure.

Noise dosimeters also supplemented the tape recorders in obtaining measures of machine emissions. The dosimeters were hand-held and set to read the noise dose at operator locations measured during a 30-sec interval of machine operation. The readouts were then adjusted to account for machine use over a longer time period. For equipment emitting impulsive noise, tape recordings of the sound at various positions around each source were made for laboratory analysis. Analysis also determined peak sound pressure levels from oscilloscope tracings of the tape-recorded signals.

After noise exposures were determined, additional measurements were made to help identify the cause of the excessive exposure.

### 2.2.3 Noise source analysis

Acoustic measurements were taken close-in to each machine to provide data for assessing the role of individual machines or machine parts in causing a noise exposure. Here, frequency analyses were performed so that characteristic noise signatures of machines or machine parts could be related to more distant (operator position) noise measurements. Measurements of surface vibration (a common source of noise) were also used to help gauge the significance of those vibrations to the noise emissions.



The influence of room acoustics on the propagation of sound in the sheet metal shop was also studied in the noise source analysis. Spatial and room surface configurations cause reflections of sound that influence sound levels away from a continuous noise-maker, where the combined echoes of the noise from all room surfaces are more intense than the sounds directly radiated by the noise source. These factors are accounted for by characterization of "room constants" through measurement of reverberation time or through calculation.

By either method, the room constants for various subareas of the shop are all high, meaning that the distance from a noise-maker to where reverberation (echoes or reflection) becomes significant ranges from about 10 ft (under the shears area under the acoustical ceiling) to about 15 ft (at the opposite end of the shop). These distances are on the order of two to three times farther from a noise source than in typical industrial facilities where conditions are more crowded and acoustical wall or ceiling treatments are usually not present.

The large distances benefit CNSY workers in that if a worker is within 10 to 15 ft of a noisy activity, he is not as noise impacted by reflected sound. The benefit is small, however, because most shop noise exposures are dominated by noise from personal activities, rather than from neighbor's work (except for the grinding areas). On the other hand, in industrial operations reverberation may be a very significant factor, and it may be desirable to seek ways to decrease reverberation, through application of ceiling or wall treatments.

### 2.3 Additional Data Obtained

For this project, information on other noise studies of sheet metal working equipment was obtained through a literature review of articles containing noise data or noise control data. Summaries of articles and of publicly available reports gleaned from bibliographies and reviews of journals in the field of noise control are presented in Appendix B.

### 2.4 Synthesis of Information

An evaluation of all of this information - in conjunction with usage factors - enabled us to determine whether or not a particular sheet metal working machine currently represents a noise hazard at the CNSY or whether it could represent a noise hazard in another sheet metal shop with different operating patterns or room conditions. For each machine identified as a cause or as a potential cause of a hazard, the data were again reviewed for ways to control noise emissions from that machine. Under this project, only techniques that could be applied to existing machines were considered, and those noise control techniques that would involve research and development were intentionally omitted. Possible controls were recommended from that list on the basis of acoustical effectiveness, conformity with existing operations, safety, and minimal interference with production.

### 3. ANALYSIS OF NOISE ASSOCIATED WITH INDIVIDUAL MACHINES

This section presents the analysis of the data obtained for individual sheet metal shop machinery. The noise emissions and use patterns of each machine are described. The hazard of the noise emission is assessed, and noise generation processes are outlined for those machines whose emissions are hazardous. Where appropriate, recommendations to control the noise emissions from a machine are given.

#### 3.1 Band Saw S.N. 057962

Data were obtained for this saw as 18-gauge aluminum, 1/4-in. aluminum, and 1/8-in. mild steel were processed. Sound levels at the operator positions exceed 84 dB(A) only during cutting, when sound levels at these positions increase to above 90 dB(A). Sound levels at the operator positions vary as the workpiece is moved during cutting; the highest values occur when the stock is skewed and when pressure is exerted on the workpiece. Time-averaged noise emissions at the operator positions are on the order of 97 dB(A) and can vary  $\pm 3$  dB, depending on the material being cut and the desired configuration of the end product. Maximum permissible daily exposure to sounds at 97 dB(A) is about 1 hr under the DOD-based criterion. The band saw is frequently used for more than 1 hr a day and is occasionally in constant use. This machine is thus considered to be a noise hazard, and a noise reduction of about 13 dB at the operator positions is required to satisfy the criterion of 84 dB(A) for an 8 hr exposure for the constant-use situation.

Sound levels 6 ft away from the saw blade (by a nearby workbench) are about 12 dB lower than at the operator's ear position and thus average about 85 dB(A) during cutting. However, the area closest to the place where the saw is normally manned is about 30 ft farther away, and, at that distance, average sound levels caused by the saw operation are always below 84 dB(A). This machine thus does not cause a noise hazard to nonoperators in this location, but could in other industrial facilities.

Simultaneous tape recordings of saw noise emissions and surface accelerations of the stock and various saw components indicate that the stock vibration, induced in the workpiece by the repetitive forces applied to the stock by the teeth of the saw blade, is the principal noise source of the saw. Secondary noise sources are vibration of the saw blade itself and vibration of the blade guard and blade guide fixtures.

We do not see any practical method to alleviate the noise hazard of the band saw completely. However, implementation of the treatments described below can eliminate the hazard on typical days, when cutting is performed for no more than three hours, and can reduce the hazard significantly at other times.

#### *Recommendations*

Design and install a transparent noise barrier for the saw, to be supported by the saw superstructure, to shield the operator from sounds directly radiated in his direction from the stock, blade, and blade guide and guarding system (see Fig. 3). The noise barrier must be carefully shaped to minimize interference with the cutting operation. The operator must be able to see what he is doing; production cannot be decreased; and

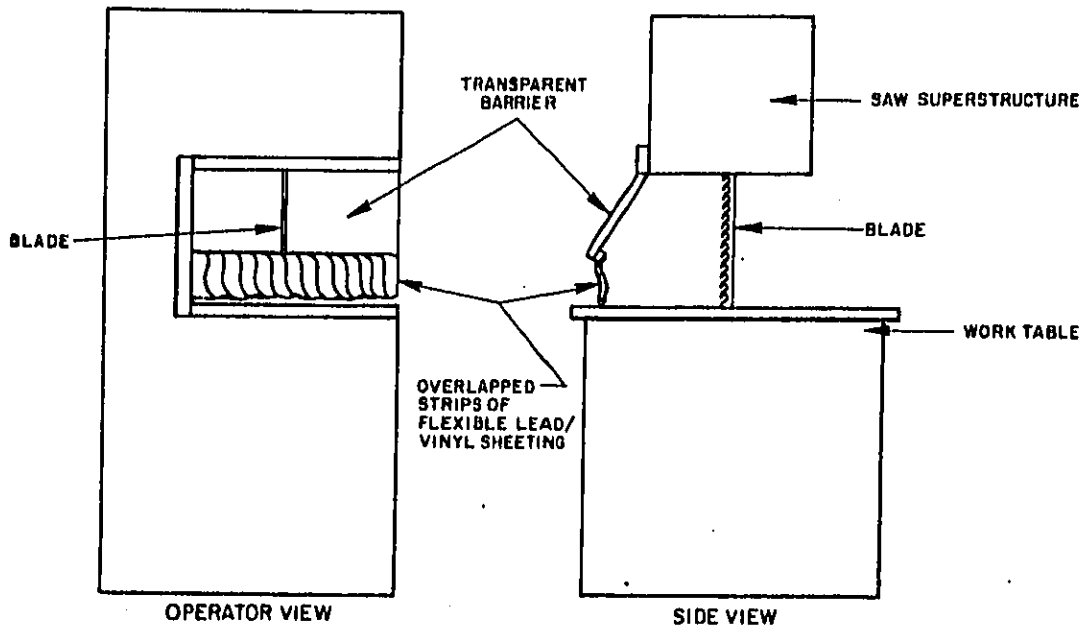

NOTE: BARRIER OF NON-GLARE MATERIAL, LOWER EDGE OF BARRIER TO BE BELOW OPERATOR LINE OF SIGHT TO CUTTING POINT.

FIG. 3. SAW NOISE BARRIER.

safety precautions must be observed. Lead/vinyl strips attached to the bottom of the shield can ease the potential access problems.

Design and construct work jigs to support various shapes and sizes of workpieces. The jigs should be designed to hold the stock firmly against the jig surfaces, which should be covered with a damping material to absorb much of the vibrational energy present in the stock as it is being cut.

Since nearby workers are far enough away that their exposures are less than 84 dB(A), no noise control treatment is recommended here to protect nearby workers from the noise emissions of the saw. However, if these workers did incur excessive exposure from the band saw sounds, we would have recommended isolation of the saw by acoustically lined walls.

The saw supported noise barrier should cost about \$500, which includes costs for materials, fabrication, and installation. The jigs should cost about \$150 each; most of the cost is for clamping hardware and damping materials. The jigs are simple enough to be fabricated on an as-needed basis for different stock configurations.

The saw requires one barrier and five jigs. The total cost for the recommended treatment is, therefore, \$1250.

Once the operators adjust to the treatment, we do not foresee any production losses from its use.

### 3.2 Friction Saw S.N. 136-865

Data were obtained for this saw as it was cutting 1/4-in. mild steel. The sound level at the operator location is a fairly constant 97 dB(A) during cutting (90% of cutting cycle) and about 87 dB(A) when idling (10% of cutting cycle). Sound levels 6 ft from the saw are 3 dB lower. The friction saw is used for longer than 1/2 hr a day and may be used constantly on occasions. This machine is thus considered to be a noise hazard, of similar magnitude as the band saw, and a noise reduction comparable to that required for the band saw is needed: 13 dB to satisfy the DOD-based criterion.

Simultaneous tape recordings of noise emissions from the saw and surface accelerations of the stock and various saw components and close-in acoustical measurements at the idling saw indicate that the stock vibration is the principal cause of the measured noise emissions, as it is for the band saw. Secondary noise sources are the saw blade and blade guard and guiding fixtures.

Noise exposures from the friction saw can be reduced by the introduction of treatments similar to those suggested for the band saw. Again, we do not see any practical method to alleviate the noise hazard of the saw completely. The retrofit treatments will probably be 1 or 2 dB more effective for the friction saw than for the band saw. The noise emissions of the friction saw are governed by higher frequency sounds which can be better attenuated by these treatments. However, additional care will be needed in selecting a suitable damping material for the jigs, because of the high stock temperatures produced by this saw.

*Recommendations*

Design and install a transparent noise shield for the operator similar to the barrier discussed in Sec. 3.1. Combine that treatment with a work support jig that will damp the stock as it is cut. These treatments can eliminate the hazard on most days and can significantly reduce it for days with heavier work loads.

No treatment is recommended to insulate nearby workers from the noise emissions of this machine, since they are not overexposed.

This saw requires one shield and two jigs; the prices for the materials are given in Sec. 3.1. The total cost is \$800.

**3.3 Punch Presses**

**3.3.1 Manual Punch Press S.N. 102488**

Data were obtained for this punch press as it cut and formed a collar of 16-gauge aluminum. The sound level at the operator position is continuous and below 80 dB(A) while the press is idling. During stamping, impulsive sounds are generated, giving rise to peak sound pressure levels of 118 to 122 dB 4 ft in front of the press. At an average peak SPL of 120 dB, about 10,000 impulses each day would be permissible under the impulse noise criterion. The total running time, including idling, on this machine is low,\* and because each punch requires

\*The meter on the side of each manual press suggests that no manual press has been run for over 700 hrs since its installation.



at least one minute of setup - which means the machine is not producing impulses - this press is not considered a noise hazard in this shop. Neither is it likely to be one in other shops.

Acceleration measurements on the press ram and die bed of Press 102488 indicate that peak accelerations exceeding 40 dB re 1 g (32 ft/sec<sup>2</sup>) occur on these surfaces during punching. These data indicate that the entire press is set into vibration during punching, and this vibration causes the sound measured at 4 ft. To reduce the noise of this machine without radically changing its design requires that the entire press be treated. The simplest way to do this is to enclose the press by surrounding it with an acoustical curtain assembly and to relocate the press controls so that the operator would have to work the press from outside the enclosure. Noise reduction of at least 10 dB could be expected from such treatment.

#### *Recommendations*

Because this machine is seldom used, we do not recommend installation of any noise controls for it at this time.

#### 3.3.2 Punch Press S.N. 102521

Data were obtained for this Bliss 65-ton punch press as it processed 1/8-in. aluminum. The sound level at the operator position during idling is below 80 dB(A); the predominant noise emission results from the impact during stamping. The peak SPL at the operator position is 108 dB. Since the operation is manual, relatively few impulses are generated. This machine is not considered a noise hazard, and no noise controls are recommended at this time.

### 3.3.3 Numerically Controlled Punch Press S.N. 041100

Data were taken at and around this machine as it processed 1/8-in. mild steel. The sound level at the operator position (by the console) is in the high 70-dB(A) range as the press idles; the sound is a combination of the whine from the hydraulic system power unit behind the press and the background sounds. Periodically, as the machine punches, an impulse that has a peak SPL of 106 dB is generated at the operator position.

Neither the continuous noise nor the impulsive noises are considered hazardous in this shop. Workers in industrial shops may be stationed much closer to the press, however, and some noise control may therefore be appropriate in those situations. The impulse sounds originate mainly at the air exhaust behind the press, and can be reduced by installing a high quality, commercially available muffler on the pneumatic exhaust. The power unit noise can be suppressed either by moving the unit to a remote location or by partially enclosing the unit (leaving only sufficient openings to allow necessary airflow to pass through the enclosure). An effective enclosure would require a lining on the interior of the enclosure, made of 2-in. to 3-in.-thick acoustically absorbent material, such as glass fiber blanket insulation.

#### *Recommendations*

Because of its low hazard potential, no noise control treatment is recommended here for this machine.

### 3.4 Hand Tools

#### 3.4.1 Angle grinder

Data were obtained for this hand tool as it was being used to finish two kinds of products at the workbench area in midshop and a third kind in the grinding room, which is located on one side of the shop.

The data indicate that operators are exposed to high level sound, with the levels depending on the material being worked and on how the tool is used (for example, if an edge or if a surface is being ground). Measured sound levels at the operator position are between 97 and 106 dB(A) during grinding. These levels restrict daily permissible exposure time to between about 10 and 60 min under the DOD-based criterion.

Daily grinding time is highly variable but may range from between 30 min (minimum, at the workbenches) to 6 hr (maximum, in the grinding booth) per day. Clearly, the grinding tools should be considered hazardous noise sources.

In addition to the noise generated by an individual's grinding, each operator is further impacted by adjacent operations, since sound levels in the reverberant field of a grinding operation are about 85 dB(A). Thus, even when an operator stops grinding, he may incur some noise exposure from nearby operations. Compared with industrial grinding operations, the impact of the noise from neighboring grinding activity is low in the CSNY shop. Grinding is more intermittent here and groups of workers are not always permanently positioned in the grinding area.

Grinding noise is composed of tool noise (the free-spinning tool itself generates sound levels of 90 dB(A) at the

operator's ear position) and the more significant workpiece noise. Although tool noise is relatively easy to correct (mufflers are generally available that fit over the tool exhaust ports and attenuate the noise escaping from the ports), the stock vibrations are more difficult to reduce.

#### *Recommendations*

Retrofit the 100 grinding tools with commercially available mufflers. The mufflers cost about \$10 each and each can be installed in minutes. The total cost for this treatment is about \$1000.

Provide a stock-support system. Workpieces can be securely supported, and stock can be rested on materials that can absorb some of the vibrational energy. Beds of sand have been used for this purpose. The anticipated benefit is on the order of 3 to 5 dB noise reduction. The cost is about \$100 each; five are needed. The cost would be \$500. Also provide damping blankets so that the stock can be partly covered during grinding. Damping materials or heavy blankets can be used to cover the unworked stock surface. The anticipated benefit is 5 to 7 dB noise reduction. The damping blankets will cost about \$50 each; 15 are needed, so this cost will be about \$750.

Schedule all grinding operations that will last longer than 2 hrs in the grinding room. In this room, install individual workstation booths, such as shown in Fig. 4. We anticipate that 7 to 10 dB of noise reduction can be achieved with this treatment. The individual booths should be fitted with a counterbalanced transparent front cover that shields the operator from sound coming directly from the stock. The operator should be able to lift the cover out of the way, so that he can

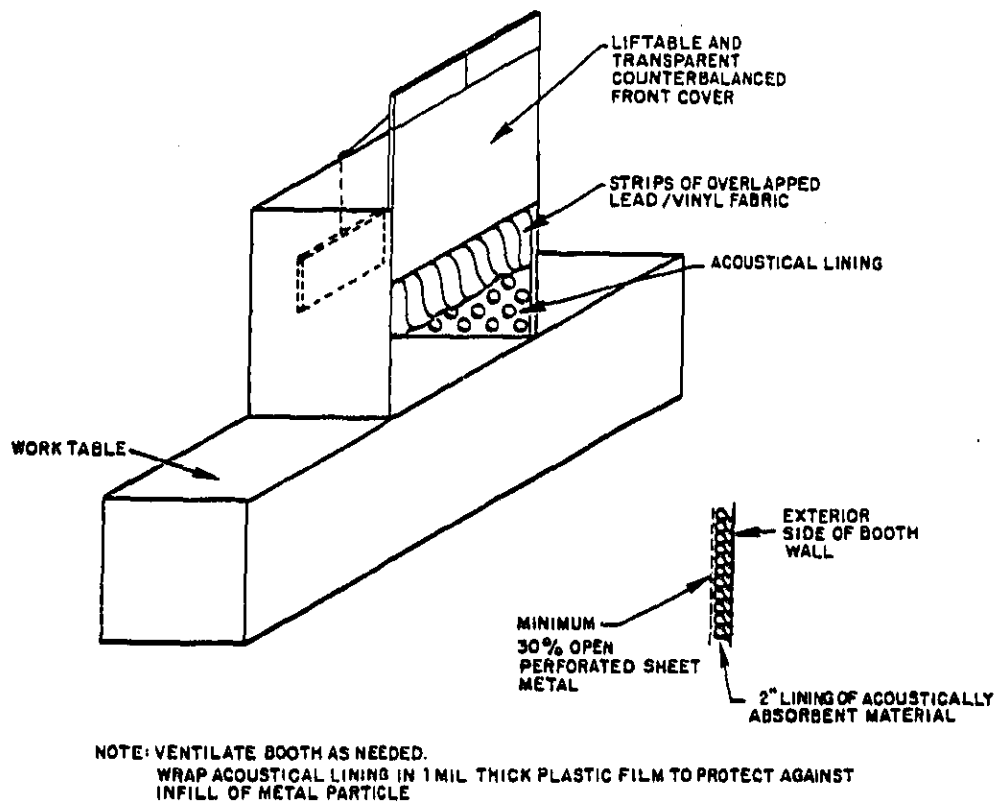

FIG. 4. GRINDING WORKSTATION BOOTH.

have access to the interior of the booth. The booth should be acoustically lined and should be sufficiently large to accommodate the stock sizes normally processed. We estimate the cost for such a booth at about \$2500.

The total cost for these recommended treatments is about \$4750. We see some minor production loss caused by use of the treatments, mainly from the time spent on repositioning blankets.

#### 3.4.2 Pneumatic drills

Data were obtained for this hand tool as it was operating in muffled and unmuffled modes. A sound level of 80 dB(A) was recorded for the former, and 93 dB(A) for the latter. Clearly, mufflers should be installed on all air drills.

#### 3.4.3 Router

The router is used to finish products called "polyblocks" in the nuclear area of the shop. Data were obtained at the operator position of this tool during normal processing and as it was run in the free-spinning mode outside the portable booth in which it is normally used.

In the normal operating mode, the operator is exposed to between 100 dB(A) and 110 dB(A), with an average exposure of about 106 dB(A). These levels pose a significant hazard to the operator for long periods of exposure; in fact, under the DOD-based criterion the daily permissible exposure to such levels is less than 13 min. Since the router is used constantly on occasion, its operation is hazardous here and probably in other shops as well.

Sound levels outside the operator booth during normal operations are considerably lower than those inside, averaging 87 dB(A) at 18 ft in front (open end) of the booth and just under 85 dB(A) at 18 ft behind the booth.

Data obtained when the router was free-spinning indicate that the tool itself emits a continuous level of 97 dB(A) at the operator position. These emissions, caused by a combination of internally generated sounds escaping out of the casing openings and by vibration of the tool casings, are apparently overshadowed by the sounds caused by induced workpiece vibration when the tool is being used. Thus, although the tool could be quieted by vibrationally isolating and damping the tool casing and by installing a specially designed muffler to attenuate the escaping internal sounds, the usefulness of these efforts will be limited by the noise of the vibrating stock.

Workpiece vibration can be reduced by:

1. Using a different work support system that constrains the stock from vibrating and that damps the vibrations (such as a sandbed on to which the stock is firmly secured).
2. Covering the unworked surfaces with a heavy, limp, flexible blanket.

The noise reduction obtained by either of these methods is not very amenable to prediction, but a reasonable expectation for each method is about 5 dB. The reduction could possibly be as much as 8 dB if both procedures are used. Treating the tool itself may provide an additional 1 or 2 dB of noise reduction. To reduce noise exposure further, it is necessary to rethink the polyblock construction process, so that some of the work performed by the router can either be done at an earlier stage in the product construction (for example, when the polyblock

surfaces are not yet joined together) or be eliminated completely (for example, by eliminating welding).

Nearby worker exposures will be reduced in proportion to the reductions at the operator position if the above treatments are attempted. However, the exposure of nearby workers can also be reduced by improving the acoustical performance of the existing booth. An acoustical curtain could seal the front of the booth, which is now open. Similar material could be used to seal the gaps in the booth along its perimeter. Containment of router sounds to inside a special booth, as is the case in the CNSY shop, is recommended for other shops with router noise problems.

#### *Recommendations*

Install the booth treatment, the work support systems, and the tool treatments described above. We estimate costs for these treatments at about \$1100.

Some operator inconvenience should be anticipated because the tool treatments will make the router larger and slightly heavier, and because additional time will be required to secure the stock properly with the new work support system.

### **3.5 Square Shears**

Data for each shear were collected for operational modes in which no metal was cut and in which several kinds and sizes of metal were cut. Acoustical data were taken at the operator position, around the periphery of the machine, and close-in to suspected noise sources. In addition, acceleration measurements were made on various machine surfaces.



Each of the three shears grouped together at one end of the shop produces fairly similar sounds. Each shear is quiet (under 70 dB(A) close-in) when it is idling, but each also produces one or more high-intensity, brief noise impulses when it cycles. Because the sounds are impulsive, tape-recorded data were made, and the recordings were reduced in the laboratory to make possible the determination of peak SPLs and the time histories of the impulses. Results indicate that the highest peak SPLs for each shear occur during the clamping phase of the duty cycle, when the holddown clamps slam down on the work surface. Results further indicate that the peak SPLs of each shear at any position are generally independent of the material being processed. In fact, the SPLs are as high even if no material is being processed. Table 1 summarizes the findings.

TABLE 1. SOUND PRESSURE LEVELS OF SQUARE SHEARS

Shear No.	Peak SPL at Operator Position	Peak SPL 30 ft from Center of Shears
102503	120	108
102504	127	112
127987	121	104

The hazard caused by the shears is related both to the number of impulsive sounds that occur and the intensity of these sounds. Table 2 lists the maximum permissible number of impulses for the peak SPLs listed in Table 1 for the operator position.

TABLE 2. MAXIMUM ALLOWABLE NUMBER OF IMPULSES FOR PEAK SPLs OF SHEARS

Shear No.	Peak SPL	Allowable No. Impulses*
102503	120	10,000
102504	127	2,000
127987	121	8,500

\*These allowable impulses are based on the criterion discussed in Section 2.1.

Shear No. 102504 is the most critical noise offender, and its operator is most impacted by the noise. However, estimates of the number of cuts indicate that no more than 1000 cuts are made daily for all three shears on normal days; thus, even Shear No. 102504 does not constitute a noise hazard. During the occasions when the shears may be operated continuously, we calculate that as many as 15,000 impulses could be anticipated; then a noise hazard for any of the shear operators will be present. This number also represents the approximate upper limit of production for any shear in any shop.

Data indicate that peak SPLs drop off at approximately 6 dB/doubling of distance from the shears. Therefore, other workers who spend little time in this area would not experience a noise hazard, even when the shears were operated continuously. In industrial shops, where operations are in closer proximity, other workers could be noise impacted by shear operations.

Under the impulse noise criterion used here, the maximum peak SPL should not exceed 118 dB for 15,000 daily impulses. A noise reduction of up to 9 dB may be called for each shear in this shop. In shops where several shears may be in simultaneous and continuous operation, additional noise reduction may be

necessary because of the combined influence of the individual machines. (In these cases, additional noise reduction could be provided by isolating the individual machines with partitions.)

The mechanism of generation of the audible impulses is not fully understood at this time; however, the data clearly show that the noise impulses are intimately associated with the action of the holddown clamps. Thus, peak SPLs can be reduced by softening the blows delivered by the clamps.

Although we have indicated that the major noise source on each source is the holddown clamps, other noise sources exist. On the Lodge the Shipley shear (No. 127987), a pneumatic system is used to drive the clutch and operate the brake. Twice during each duty cycle, air is exhausted through an unmuffled pipe behind the shear. Peak SPLs near this exhaust are almost as intense as the clamping noise. This pipe should be muffled with a commercially available exhaust muffler.

Other secondary noise sources on each shear include the sounds of the clutch engaging and the clutch pin striking its stop. These noises can be reduced by redesigning the clutch mechanism, but this work is not considered necessary at this time, as the peak SPLs at the operator position from these actions are at least 18 dB below that of the major noise sources.

#### *Recommendations*

Muffle the exhaust pipe on Shear No. 127987. The cost for the muffler is about \$50.

Purchase and install for evaluation a holddown clamp retrofit kit for one of the shears. The two manufacturers of the shears used in the shop have "retrofit kits" available. The kit

allows the clamps to be more gently lowered onto the work surface before shearing. Telephone conversations with the manufacturers indicate that a noise reduction of 8 to 10 dB can be achieved by this method. The cost is about \$1000 per machine, plus installation. The installed cost for one kit should be no more than about \$2000.

Design, procure, and install for evaluation a series of softer holddown clamp cushions. The cost for each cushion is about \$40; 10 cushions are needed for each shear. The total cost (including installation) is then about \$500 for each shear.

The estimated total cost for the noise control treatment for the three shears is approximately \$7550.

We anticipate no interference with normal operations from these treatments.

3.6 Nibblers

3.6.1 Nibbler No. 105238

Data, taken for this machine as it processed 1/4-in. mild steel, included acoustical measurements at the operator position and at a 10-ft distance from the machine and acceleration measurements on the stock and nibbler surfaces. Noise emissions of this machine consist of a series of rapidly occurring impulses. Because of this rapid succession, the emissions are treated in this discussion as if they were continuous.

Sound levels at the operator position average 93 dB(A) and about 10 dB less at a 10-ft distance when the nibbler is cutting metal; the levels are no higher than background sound levels when the machine idles. These high sound levels limit an operator's permissible exposure to 2 hrs of cutting a day under the DOD-based criterion.

Analysis of the data indicates that the recorded sound levels are caused almost entirely by vibration of the stock, which is set into vibration by the repeated impacts of the cutting tool and by the repeated slapping of the stock against the table surface.

*Recommendations*

Noise emissions can be reduced at the source by:

1. Preventing the stock from "ringing" (by applying damping to the stock as it is cut)
2. Preventing or cushioning the stock slap.

Both types of reduction can be achieved by modifying the stock holddown system. Work can be supported on a jig that

provides a cushion (such as neoprene) between the stock and the table and also provides a layer of sheet damping material between the stock and the tiedown to the jig. We would expect at least a 5-dB noise reduction from this treatment. We obtained this decrease at the shop by the simple application of a layer of magnetically backed damping material to the mild steel as it was worked. The damping material did not affect the stock slap.

Noise exposures for this machine could also be reduced by devising an alternative method of feeding stock into the machine. At present, the operator holds the stock and applies leverage to it by pushing with one hand and pulling with the other. When this action is inadequate, the operator uses a vise-grip to grasp the side of the stock he pulls. In this procedure, the operator's ears are positioned quite close to the principal noise source. Alternatively, a longer lever arm could be used. Provide the operator with a specially made tool that he can use to grasp the stock while standing 2 or 3 ft farther from the machine. An additional noise reduction of 7 to 8 dB is possible using this approach, depending on the length of the tool. The estimated cost for both of these treatments is about \$500. Once the operator has become accustomed to the treatment, no loss of production should occur.

### 3.6.2 Nibbler No. 129366

Data were taken for this machine as it processed 1/4-in. aluminum. Noise emissions come from a source of rapidly occurring impulses; these emissions are also treated as if they were a continuous noise.

Sound levels at the operator position average about 85 dB(A) during cutting. Therefore, the emissions do not

constitute a noise hazard. In addition, because the operation is automatic - the stock is fed by a ratchet-driven arrangement on the machine - the operator can position himself farther away from the machine or be shielded from it, if desirable.

*Recommendations*

No noise control treatment is recommended for the machine at this time.

**3.7 Belt Sander No. 141547**

Data were obtained for this grinding machine as it idled and as it processed material. The noise emissions are continuous and range from 92 dB(A) (at the operator position) during idle to 102 dB(A) when the coarser sanding belt is used. Sound levels 6 ft from the machine, at positions that could be occupied by other workers in the grinding room, are about 7 dB lower than at the operator position. According to the DOD-based criterion, this machine presents a noise hazard to the operator on days when it is operated for more than about 30 min a day.

Analysis of the data indicates that the high-level idling noise originates at the slave pulley, where a combination of irregularities on the contact surfaces of the sanding belt and imperfections in the slave pulley bearings set the slave pulley and its guard into high-frequency vibration. The operating noise originates at the stock/belt interface, where both the belt and stock are set into vibration during contact.

*Recommendations*

Enclose the entire sander with a free standing construction made with sufficient access panels for machine maintenance and inspection. Furnish the enclosure with recessed twin openings in the front facing of the box for working stock, with the openings sized so that the belts protrude through the front facing with minimal clearance (see Fig. 5). Line the interior surface of the enclosure with minimum 2-in.-thick acoustically absorbent material, protected with a 1-mil thick loose fitting wrapping of plastic film (Mylar or Tedlar) to prevent infill of the acoustical material with metal particles. Furnish the enclosure with a small ventilation unit to provide cooling for the unit.

The enclosure treatment should provide about a 7- to 10-dB reduction in sound levels at the operator position during sanding; the reductions should be even greater when the machine is at idle. Such a noise reduction will eliminate the noise hazard of the sander to other workers and triple to quadruple the permitted working time for sander operators. Although this concept may appear cumbersome, this type of treatment has worked successfully on other sanders.

The estimated cost for such a treatment is about \$3000. The maintenance time required for the sander will increase, as more time will be needed to dismantle and replace sections of the enclosure.

**3.8 Abrasive Cutoff Saw**

Data were obtained for this machine during our initial visit as it cut 2-in. x 2-in. x 1/4-in. mild steel angle iron.



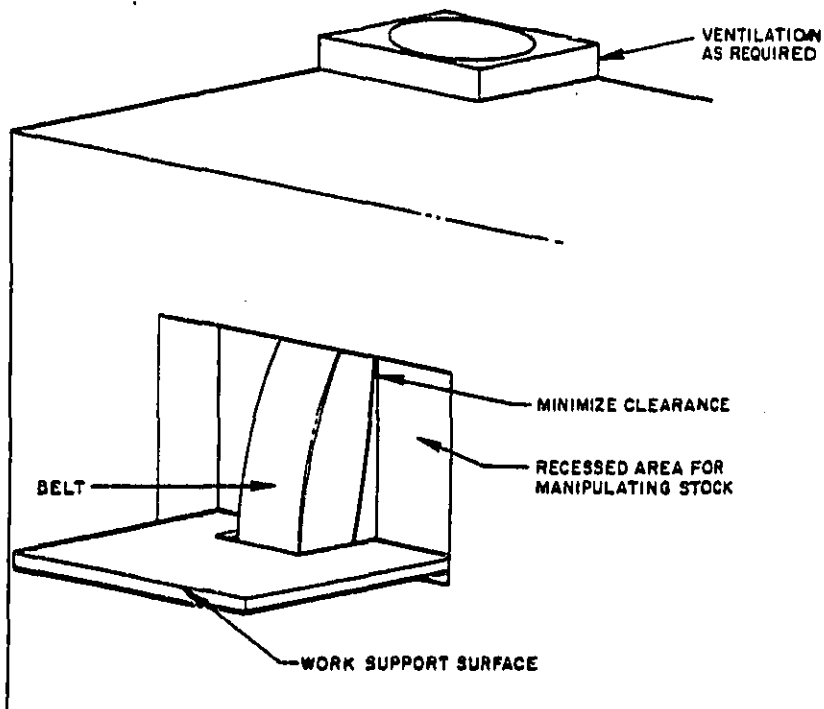

NOTE: INSIDE OF ENCLOSURE LINED WITH 2" THICK ACOUSTICALLY ABSORBENT MATERIAL  
LOOSELY WRAPPED IN 1 MIL THICK PLASTIC TO PROTECT AGAINST INFILL OF METAL PARTICLES

FIG. 5. BELT SANDER ENCLOSURE (DETAIL OF MACHINE WORK AREA).

This machine was subsequently replaced with a quieter unit, which was measured on BBN's next visit as it cut the same material. The sound levels at the operator position for the original saw ranged from 97 to 105 dB(A) during the 10-sec cutting period and momentarily reached as high as 106 dB(A) during the air release associated with operation of the saw. Average sound levels for a 20-sec cutting cycle were about 98 dB(A). Sound levels outside the saw booth were 13 dB lower. Sound levels at the operator position of the new saw are lower, ranging from 90 dB(A) to 94 dB(A) (average, 92 dB(A)) during cutting. No pneumatic system is used with the new saw.

The operation of the old saw represented a noise hazard to the operator when the total cutting time exceeded 1/2 hr. the new saw is run too infrequently to be hazardous.

Analysis of measurements of noise emissions near the various components of the two saws show clearly that the principal noise source is blade vibration during cutting. The new saw is quieter because the blade is smaller and it turns more slowly. Secondary noise sources include stock vibration during cutting and, in the case of the older saw, the unmuffled pneumatic exhaust.

#### *Recommendations*

No noise control treatment is recommended for the machine at this time.

#### **3.9 Noise Sources Outside the CNSY Sheet Metal Shop**

The CNSY shop is impacted by operations in the adjacent shops. In particular, operation of a chipping hammer in the shop

bordering the CNSY shop along the long common wall causes sound levels measured in the mid-80-dB(A) range throughout the CNSY shop. Although these intrusive sounds are not considered a hazard under the DOD-based criterion, they do represent a source of irritation and annoyance to shop personnel.

The intruding sounds can be significantly attenuated by sealing off all the windows on the wall common to the two shops. Virtually any impervious material, such as sheet metal, can be used, and it need not be lined with absorbent material. However, leaks along the perimeter of the applied material should be eliminated by using either caulking material or gasketing.

The benefits of such treatment will depend primarily on the reduction in open (window) area of the wall: Each halving of open area yields about 3 dB of reduction in intruding sounds. Thus, only 3 dB could be expected if half the windows were treated. An improvement of only 3 dB would be barely detectable. Three-fourths of the windows would require treatment to obtain a 6-dB improvement, seven-eighths to get 9 dB, and fifteen-sixteenths to get 12 dB.

#### *Recommendations*

No treatment is recommended; however, if it is desired to reduce the intrusive noise to a point approaching the background sound level in the CNSY shop, then the entire window area of the wall requires treatment.

#### **3.10 Summary**

Table 3 summarizes the recommendations and the estimated costs for each of the machines for which treatment is recommended.

TABLE 3. SUMMARY OF RECOMMENDATIONS AND ESTIMATED COST AND BENEFIT BY MACHINE

<u>MACHINE</u>	<u>RECOMMENDATION</u>	<u>COST</u>	<u>BENEFIT</u>
Band Saw S.N. 057962	Transparent noise barrier (Figure 3) Damp Stock	\$1250	5 dB
Friction Saw S.N. 136-865	Transparent noise barrier (Figure 3) Damp Stock	\$ 800	6 dB
Manual Punch Press S.N. 102488	Due to usage this machine is not a problem	-	-
Punch Press S.N. 102521	Due to usage this machine is not a problem	-	-
Numerically Controlled Punch Press S.N. 041100	This press is no longer in the shop	-	-
Angle Grinder	Mufflers on exhaust Stock support system Damping Blankets Workstation booths (Figure 4)	\$4750	5 to 8 dB (10 to 15 dB in grinding room)
Pneumatic Drills	Mufflers on exhaust		5 to 8 dB
Router	Operator's booth Stock support system Tool treatment	\$1100	5 to 10 dB
Square Shears S.N. 102503 S.N. 102504 S.N. 127987	Muffle exhaust on S.N. 127987 Install holddown clamp kit and softer clamp cushions	\$7550	8 to 10 dB
Nibblers S.N. 105238	Modify stock holddown system Modify stock feed tool	\$ 500	5 to 8 dB
S.N. 129366	Not a problem	-	-
Belt Sander S.N. 141547	Total enclosure with maintenance and stock openings (Figure 5)	\$3000	7 to 10 dB
Abrasive Cutoff Saw	Although the old saw was a problem, it has been replaced and the new saw is quieter and not a problem	-	-
Chipping operations in shops adjacent to Shop 17	Not a noise hazard. Sealing-off of the walls between the offending shop and Shop 17 can reduce the annoyance of these operations	-	-

#### 4. EQUIPMENT DATA AND DATA ANALYSIS

Data and conclusions for each equipment type studies in this project are summarized in this section. Each even-numbered page contains a description of a particular machine. The upper part of each even-numbered page has a photograph of the machine and a sketch describing the measurement locations. The center of each page describes noise emissions for the operation of that machine, on an hourly basis (if the equipment generates a continuous sound) or on a peak sound pressure level basis (if the equipment generates impulses). Allowed exposures are given for three criteria: the DOD criterion (84 dB(A), 4 dB doubling), the OSHA regulation (90 dB(A), 5 dB doubling), and the EPA recommended criteria (85 dB(A), 3 dB doubling). The bottom of some of these pages contains a time history plot of the time-varying sound levels.

The odd-numbered page summarizes the results of the data analysis, including a synopsis of the equipment's impact on personnel, the noise sources on the machine, alternatives for quieting the machines, our recommendations, and the estimated cost and benefit. Octave band plots of particularly important measurements are also contained on some of these pages.

DATA AND CONCLUSIONS  
FOR EQUIPMENT TYPES

BAND SAW 057962  
DO-ALL MODEL 36-3

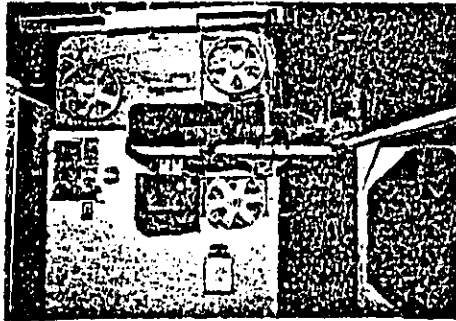

FRONT ELEVATION WITH BLADE  
COVERS LIFTED

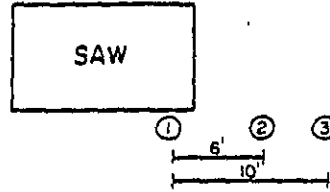

ACOUSTIC DATA  
MEASUREMENT POSITIONS  
(PLAN VIEW)

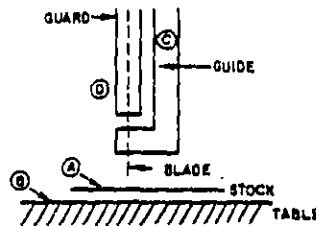

ACCELERATION DATA  
MEASUREMENT POSITIONS  
(DETAIL OF BLADE AREA)

Criterion	Hourly Exposure (% Allowed)		Typical Use <sup>††</sup> (Hr)	Typical Operator Noise Exposure (% Allowed)	Maximum Permissible Operational Time (Min)
	Operator Position (1)*	Nearest Worker <sup>†</sup>			
DOD	93	NIL	>1	>100	65
EPA	215	NIL	>1	>100	28
OSHA	28	NIL	>1	>100	21½

\*Assumes continuous use of saw.  
†Approximately 30 ft away.  
††Estimated from discussions with shop personnel.

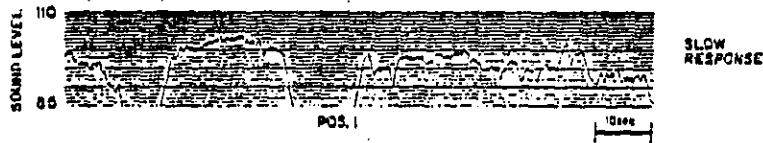

TIME HISTORY OF BAND SAW SOUND LEVELS  
AT OPERATOR POSITION

**BAND SAW 057962**  
**DO-ALL MODEL 36-3**

**IMPACT ASSESSMENT:** Machine hazardous to operator when used more than 65 min per day

**NOISE SOURCES:** Primary - Stock vibration.

Secondary - Blade vibration, blade guard vibration, and blade guide vibration.

**POSSIBLE MITIGATION TECHNIQUES:**

- Redesign blade.
- Damp stock.
- Insert noise shield.
- Combination of above.

**RECOMMENDATIONS:** Design and install noise barrier; design and install jig that damps stock.

**EXPECTED BENEFIT:** Minimum 5-dB decrease in average noise emission at operator position, and corresponding minimum doubling of maximum permissible operational time.

**EXPECTED COST:** \$1250 per saw

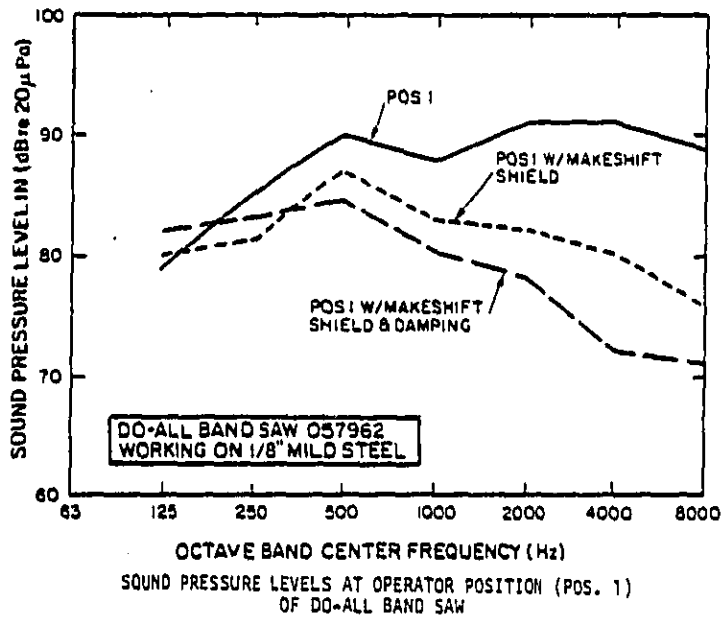



TANNEWITZ FRICTION SAW  
136865

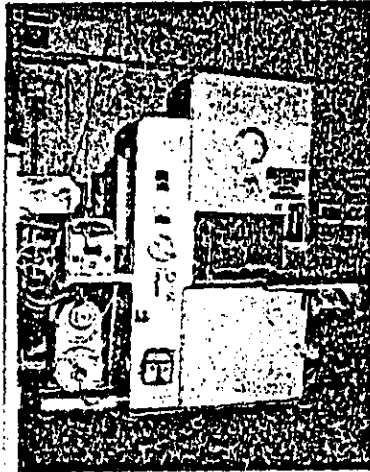

FRONT ELEVATION

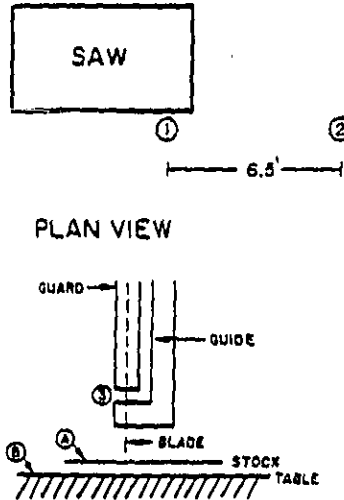

DETAIL AT BLADE AREA

Measurement Positions (circled numbers indicate acoustic data; circled letters indicate acceleration data).

Criterion	Hourly Exposure (% Allowed)		Typical Use <sup>††</sup> (Hr)	Typical Operator Noise Exposure (% Allowed)	Maximum Permissible Operational Time (Min)
	Operator Position (1)*	Nearest Worker <sup>†</sup>			
DOD	92	NIL	>½	>46	65
EPA	182	NIL	>½	>91	33
OSHA	30	NIL	>½	>15	200

\*Assumes continuous use of saw.

†Approximately 30 ft away.

††Estimated from discussions with shop personnel.

SOUND LEVELS ARE CONSTANT  
97dBA AT OPERATOR POSITION  
DURING CUTTING

**TANNEWITZ FRICTION SAW  
136865**

**IMPACT ASSESSMENT:** Machine hazardous to operator when used longer than 65 min per day.

**NOISE SOURCE:** Primary - Stock vibration.

Secondary - Blade vibration, blade guard vibration, and blade guide vibration.

**POSSIBLE MITIGATION TECHNIQUES:**

- Redesign blade.
- Damp stock.
- Insert noise shield.
- Combination of above.

**RECOMMENDATIONS:** Design and install noise barrier; design and install jig that damps stock.

**EXPECTED BENEFIT:** Minimum 6-dB decrease in average noise emission at operator position, and corresponding minimum doubling of maximum permissible operational time.

**EXPECTED COST:** \$800. per saw.

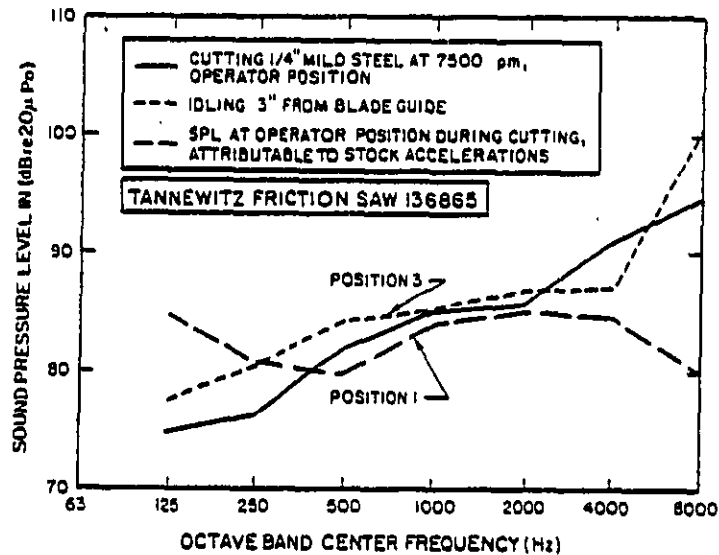

SOUND PRESSURE LEVELS AT OPERATOR POSITION AND NEAR BLADE GUIDE OF FRICTION SAW

FERRACUTE PRESS  
102488

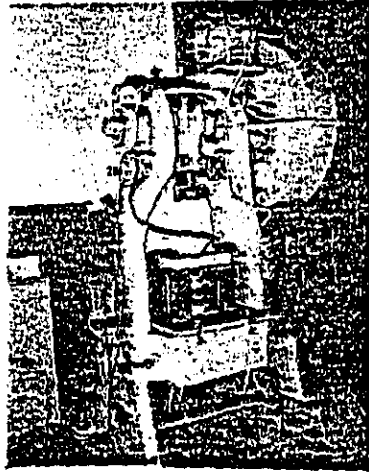

FRONT ELEVATION

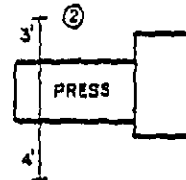

PLAN VIEW

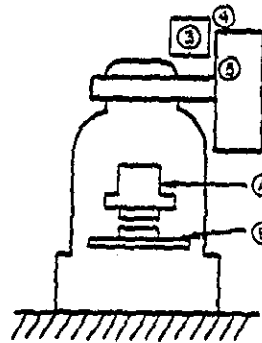

ELEVATION VIEW

Measurement Positions (circled numbers indicate acoustic data; circled letters indicate acceleration data).

Peak SPL at Operator Position = 118 dB  
Sound Level at Operator Position  
Between Punches = Ambient  
Maximum 1 Punch/Min (approximately)

FERRACUTE PRESS  
102488

IMPACT ASSESSMENT: Machine not a hazard here; not likely a hazard in other shops.

NOISE SOURCE: Vibration of press frame.

POSSIBLE MITIGATION TECHNIQUES: • Enclose press, relocating press control.

RECOMMENDATION: No noise controls are recommended for this machine.

BLISS PRESS  
102521

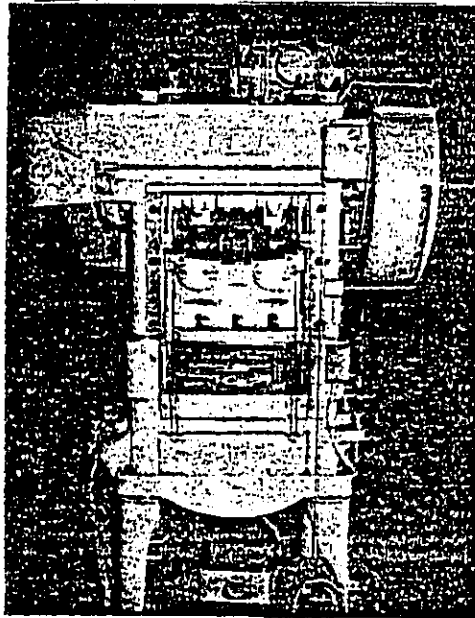

FRONT ELEVATION

PEAK SPL AT OPERATOR  
POSITION = 108 dB  
MAXIMUM 1 PUNCH/MIN  
(ESTIMATED)

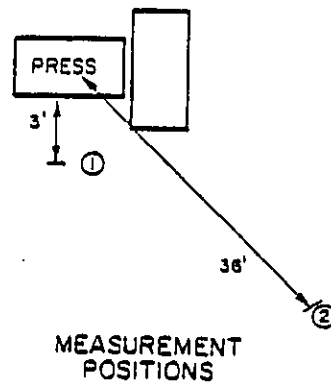

Report No. 4782

Bolt Beranek and Newman Inc.

BLISS PRESS  
102521

IMPACT ASSESSMENT: Machine not a hazard here; not likely a hazard in other shops.

RECOMMENDATION: No noise controls are recommended for this machine.

WIDEMATIC A-30  
N/C PRESS 04100

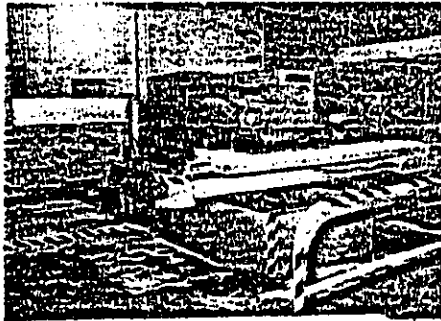

DIAGONAL VIEW

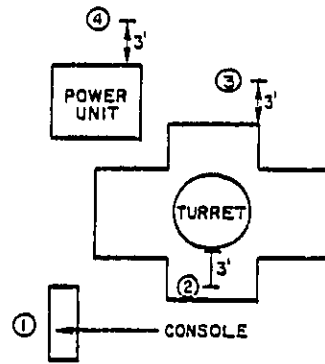

MEASUREMENT  
POSITIONS

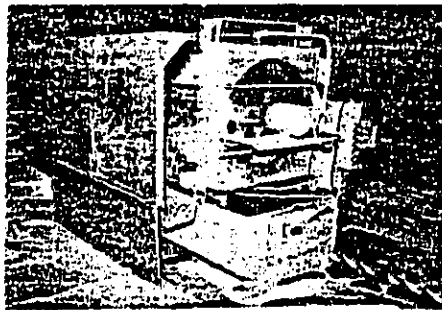

POWER UNIT

- Peak SPL at operator position = 106 dB
- Sound level between punches at operator position = 75 to 79 dBA
- Maximum 7 punches/10 sec

WIDEMATIC A-30  
N/C PRESS 04100

IMPACT ASSESSMENT: Machine not a hazard at this location, but could contribute to high noise exposures in more crowded facilities.

COMMENT: Power unit whine can be mitigated by using a lined partial enclosure (see text). Exhaust air impulse can be mitigated by using a high quality exhaust muffler.

RECOMMENDATION: No noise controls are recommended for this machine in this facility.



HAND-HELD PNEUMATIC  
EQUIPMENT

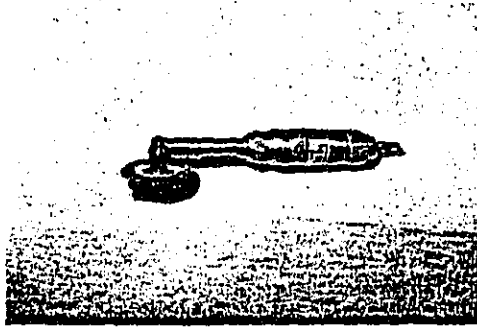

ROCKWELL 3" DISC GRINDER

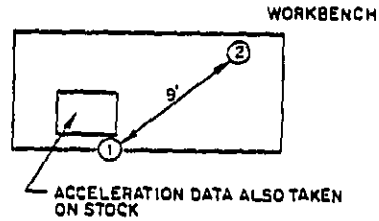

ACCELERATION DATA ALSO TAKEN  
ON STOCK

MEASUREMENT  
POSITIONS

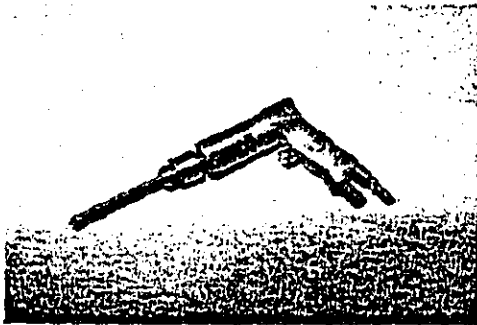

GP DRILL

Criterion	Hourly Exposure (% Allowed)			Typical Use Of Grinder (Hr) <sup>††</sup>	Typical Grinder Operator Exposure (% Allowed)		Maximum Permissible Grinder Operational Time (Min)	
	Angle Grinder* Operator Position		Drill† Operator Position		Booth	Room	Booth	Room
	Work Benches	Grinding Room						
DOD	130	182	NIL	4	520	728	46	33
EPA	300	480	NIL	4	1200	1920	20	13
OSHA	40	51	NIL	4	160	204	150	118

\*Assumes continuous operation of tool.

†Assumes continuous operation of tool with muffler.

††Estimated from discussions with shop personnel.

### HAND-HELD PNEUMATIC EQUIPMENT

**IMPACT ASSESSMENT:** Angle Grinder - Tool hazardous to operator and to nearby workers.

Drill - Tool not hazardous when muffler is intact, but is hazardous to operator when it is unmuffled.

**NOISE SOURCE:** Angle Grinder  
• Primary - Stock vibration.  
• Secondary - Tool noise  
Drill  
• Tool noise (with muffler)

**POSSIBLE MITIGATION TECHNIQUES:** Angle Grinder  
• Apply damping/blankets to stock.  
• Provide damped stock support.  
• Use gloveboxes.  
• Use booths.  
Drill  
• Maintain mufflers.

**RECOMMENDATIONS:** Install commercially available mufflers on all air tools. Provide damped stock support system and damping blankets at each workbench. Schedule all long-term grinding operations for completion in the present grinding room. Install individual work booths in the grinding room.

**EXPECTED BENEFIT:** A 5- to 8-dB reduction of average noise emissions at operator positions at workbench stations, a 10- to 15-dB reduction in grinding room. Hazard virtually eliminated.

**EXPECTED COST:** \$10 per muffler, \$100 per stock support, \$50 per blanket, and \$2500 per workbooth.

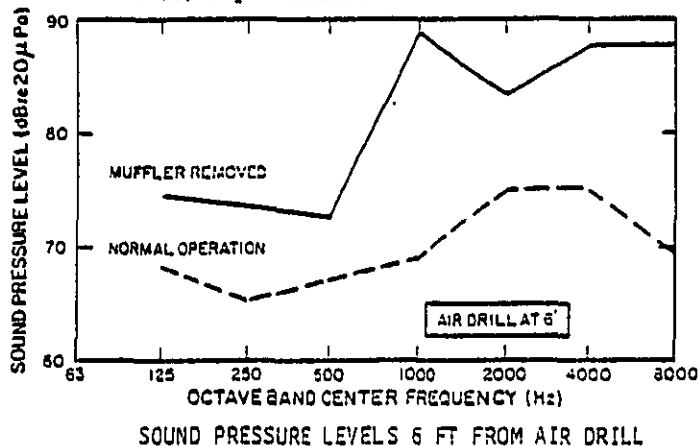

STANLEY ROUTER  
MODEL 82902

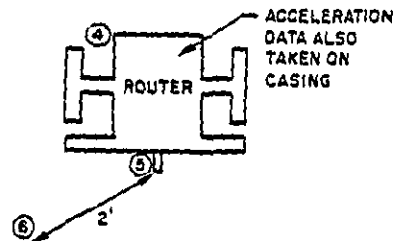
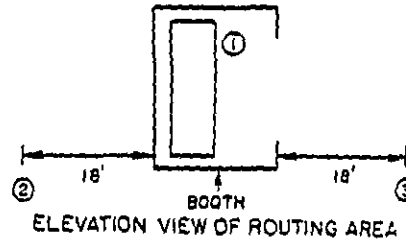
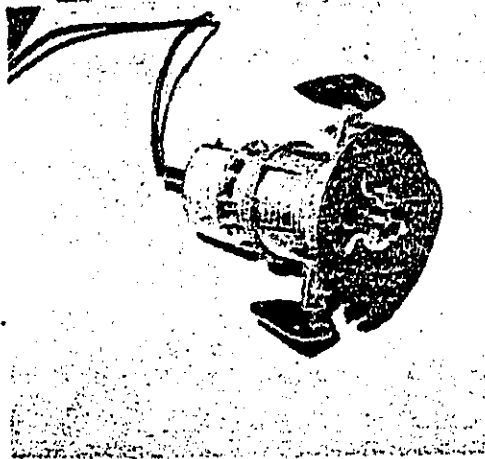

ROUTER DETAIL MEASUREMENT POSITIONS

Criterion	Hourly Exposure (L Allowed)		Typical Use (hr)	Typical Operator Noise Exposure (L Allowed)	Maximum Permissible Operational Time (Min)
	Operator*	Nearest Worker			
DOD	175	15	-	1500	15
MSA	1500	20	-	1400	-
OSHA	115	15	-	80	15

\*Assumes continuous operation of tool.  
 †Approximately 15 ft away, outside booth.  
 ‡Estimated from discussion with shop personnel.

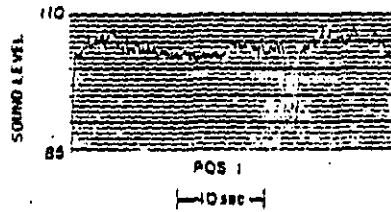

TIME HISTORY OF ROUTING SOUND LEVELS  
OPERATOR POSITION

**STANLEY ROUTER  
MODEL 82902**

**IMPACT ASSESSMENT:** Tool hazardous to both operators and nearby personnel.

**NOISE SOURCES:** Primary - Stock vibration

Secondary - Tool noise and tool vibration.

**POSSIBLE MITIGATION TECHNIQUES:** For operators

- Design and install damped stock support system.
- Cover unworked parts of stock with heavy blanket.
- Change finishing procedure to minimize use of router.
- Vibrationally isolate router casing.
- Design and install router muffler.

For nearby workers

- Close off present booth openings and add acoustical absorption to inner surfaces of booth.

**RECOMMENDATIONS:** Design and implement booth modification designs, and install damped work support systems. Develop and install tool modifications.

**EXPECTED BENEFIT:** Elimination of tool noise hazard to nearby workers. A 5- to 10-dB reduction in tool noise emission, will occur providing quadrupling of maximum permissible operational time.

**EXPECTED COST:** \$1100 per router station.

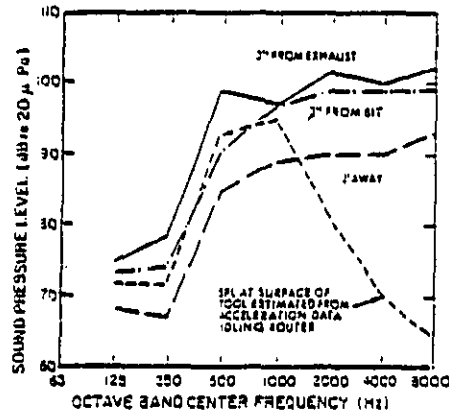

ROUTER SOUND PRESSURE LEVELS

CINCINNATI SQUARE SHEARS  
102503

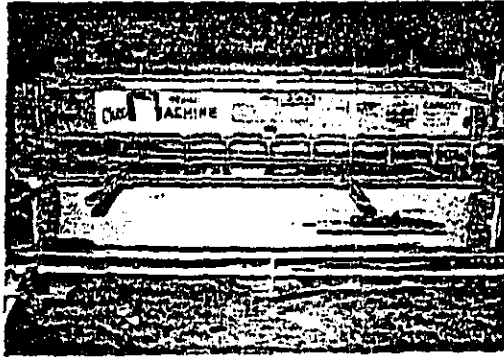

FRONT VIEW

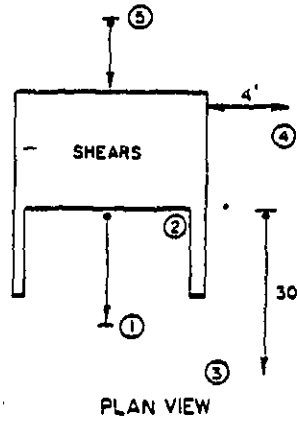
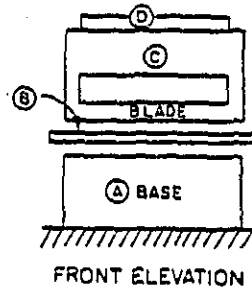

Measurement Positions (circled numbers indicate acoustical data; circled letters indicate acceleration data).

PEAK SPL AT OPERATOR POSITION = 120dB  
PEAK SPL 30' AWAY = 108dB

CINCINNATI SQUARE SHEARS  
102503

IMPACT ASSESSMENT: Machine hazardous to operator when it is operated at maximum rate for more than 5-1/2 hr/day.

NOISE SOURCES: Primary - Clamping action.

Secondary - Clutch and clutch pin engagement.

POSSIBLE MITIGATION TECHNIQUES:

- Redesign clamp drive system.
- Redesign clamp cushions.
- Redesign clamp hydraulic system.
- Redesign clamp system.
- Make use of available retrofit kits.
- Use a combination of above.

RECOMMENDATIONS: Install retrofit kit, and design and install neoprene clamp cushion.

EXPECTED BENEFIT: An 8- to 10-dB reduction of peak SPLs; shear no longer a hazard.

EXPECTED COST: \$2500.

CINCINNATI SHEARS  
102504

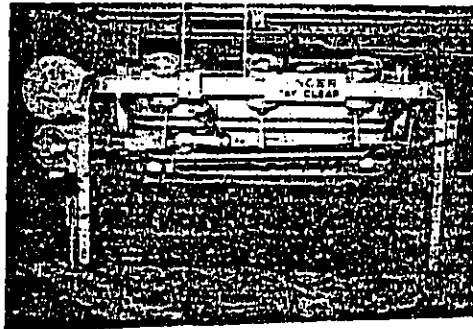

REAR VIEW

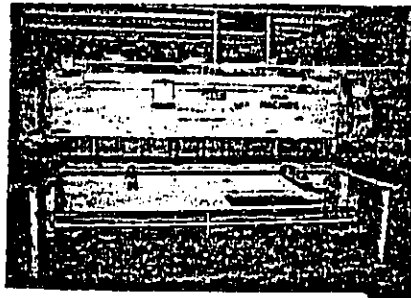

FRONT VIEW

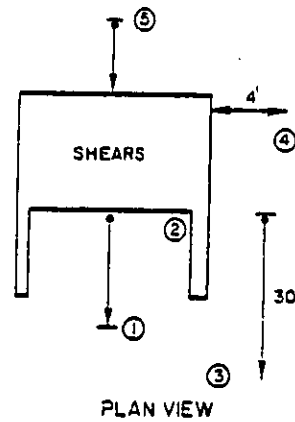
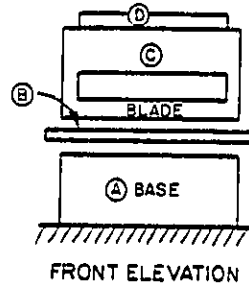

Measurement Positions (circled numbers indicate acoustical data; circled letters indicate acceleration data).

PEAK SPL AT OPERATOR POSITIONS = 127 dB  
PEAK SPL 30' AWAY = 112 dB

CINCINNATI SHEARS  
102504

IMPACT ASSESSMENT: Machine hazardous to operator when it is operated at maximum rate for more than 1-1/3 hr/day.

NOISE SOURCES: Primary - Clamping action.

Secondary - Clutch and clutch pin engagement.

POSSIBLE MITIGATION TECHNIQUES:

- Redesign clamp drive system.
- Redesign clamp cushions.
- Redesign clamp hydraulic system.
- Redesign clamp system.
- Make use of available retrofit kits.
- Use a combination of above.

RECOMMENDATIONS: Install retrofit kit, and design and install neoprene clamp cushion.

EXPECTED BENEFIT: An 8- to 10-dB reduction of peak SPLs; shear no longer a hazard.

EXPECTED COST: \$2500.



LODGE & SHIPLY SHEAR  
127987

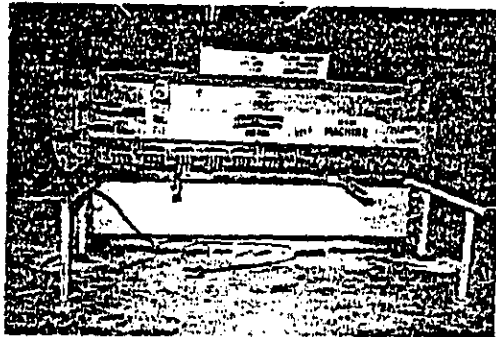

FRONT VIEW

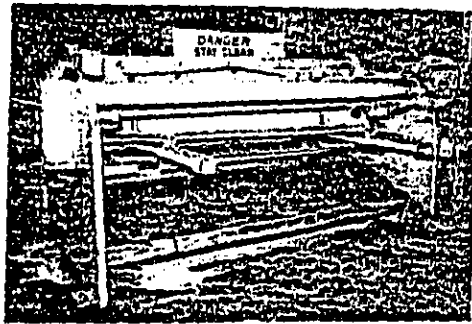

REAR VIEW

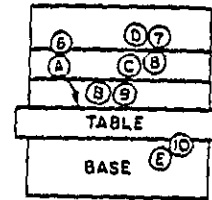

ELEVATION VIEW

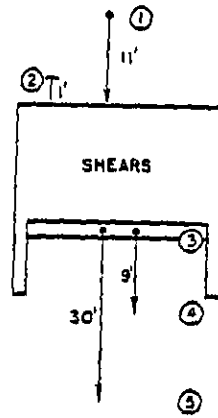

PLAN VIEW

Measurement Positions (Circled numbers indicate acoustical data; circled letters indicate acceleration data).

PEAK SPL AT OPERATOR POSITION = 121 dB  
PEAK SPL 30' AWAY = 104 dB

LODGE & SHIPLY SHEAR  
127987

IMPACT ASSESSMENT: Machine is hazardous to operator when it is operated at maximum rate for more than 6 hr/day.

NOISE SOURCES: Primary - Clamping action.

Secondary - Clutch and clutch pin engagement and air exhaust.

POSSIBLE MITIGATION TECHNIQUES:      Redesign clamp drive system.  
   Redesign clamp cushions.  
   Redesign clamp hydraulic system.  
   Redesign clamp system.  
   Make use of available retrofit kits.  
   Use a combination of above.

RECOMMENDATIONS: Install retrofit kit; design and install neoprene clamp cushion; install exhaust muffler.

EXPECTED BENEFIT: An 8- to 10-dB reduction of peak SPLs; shear no longer a hazard.

EXPECTED COST:      \$2550.

NIBBLER  
105238

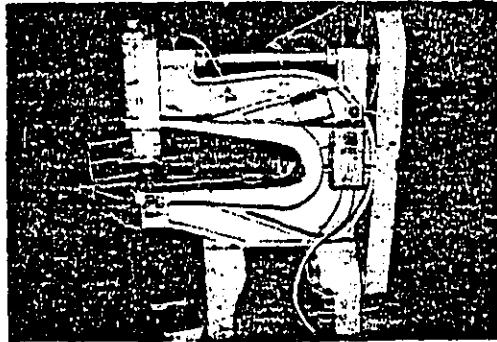

SIDE VIEW

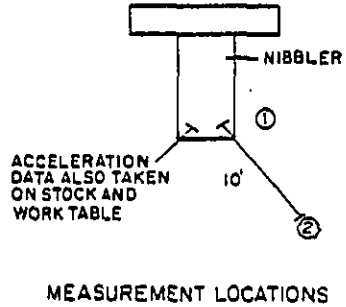

MEASUREMENT LOCATIONS

Criterion	Hourly Exposure (% Allowed)		Typical Use (Hr)	Typical Operator Exposure (% Allowable)	Maximum Permissible Operational Time (Min)
	Operator Position (1)*	10 ft Away			
DOD	50	NIL	3	150	120
EPA	79	NIL	3	237	76
OSHA	19	NIL	3	57	316

\*Assumes continuous cutting on machine.

\*Estimated from discussions with shop personnel.

PROCESSING 1/4" MILD STEEL

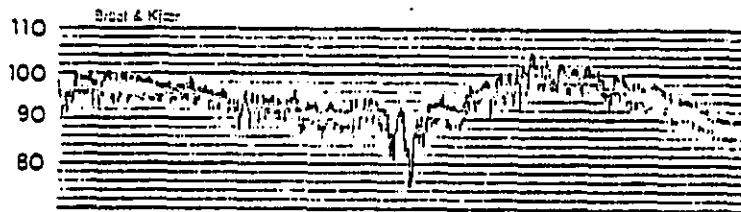

TIME HISTORY OF OPERATOR  
POSITION SOUND LEVELS

NIBBLER  
105238

IMPACT ASSESSMENT: Machine noise is hazardous to the operator when it is operated continuously for more than 2 hr/day.

NOISE SOURCES: Stock vibration induced by cutting action and by repeating slapping of stock against table.

POSSIBLE MITIGATION TECHNIQUES:

- Cushioning slap.
- Damping stock.
- Change stock feed procedure.

RECOMMENDATIONS: Design and install stock hold-down system to provide cushioning and damping; and design and implement stock feed tool, which will allow the operator to move farther away from the noise source.

EXPECTED BENEFIT: Minimum 5-dB reduction from first implementation; additional 7- to 8-dB reduction from second implementation. Nibbler no longer causes a noise hazard.

EXPECTED COST: \$500.

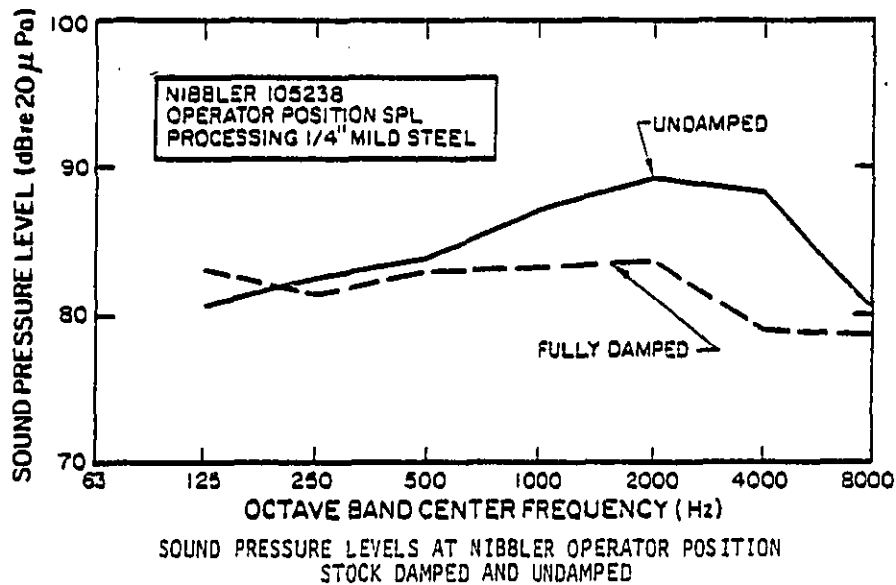

NIBBLER  
129366

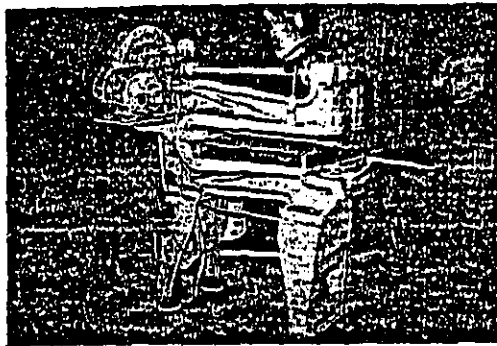

SIDE VIEW

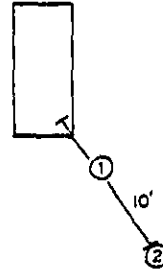

MEASUREMENT LOCATIONS  
(PLAN VIEW)

Criterion	Hourly Exposure (% Allowed)		Typical User (Hr)	Typical Operator Exposure (% Allowed)	Maximum Permissible Operational Time (Min)
	Operation Position (1)*	10 ft Away			
DOD	13	NIL	4	52	Unlimited
EPA	13	NIL	4	52	Unlimited
OSHA	NIL	NIL	4	NIL	Unlimited

\*Assumes continuous cutting on machine.

†Estimated from discussions with shop personnel.

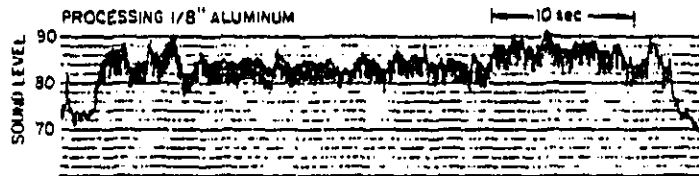

TIME HISTORY OF OPERATOR POSITION SOUND LEVELS

Report No. 4782

Bolt Beranek and Newman Inc.

NIBBLER  
129366

IMPACT ASSESSMENT: Machine not hazardous here, not likely a hazard in other shops.

COMMENT: Noise exposures can be lessened by moving the operator away from machine.

RECOMMENDATION: No noise controls are recommended for this machine.

BELT SANDER  
141547

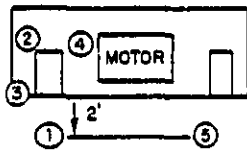

MEASUREMENT POSITIONS  
(PLAN VIEW)

Criterion	Hourly Exposure (% Allowed)	Typical Use† (Hr)	Typical Operator Exposure (% Allowed)	Maximum Permissible Operational Time (Min)
	Operator Position*			
DOD	199	4	796	30
EPA	520	4	2080	11
OSHA	56	4	224	107

\*Assumes continuous operation of machine, using coarser belt.

†Estimated from discussions with shop personnel.

SOUND LEVELS CONSTANT AT 102 dBA AT OPERATOR POSITION DURING COARSE SANDING,  
92 dBA DURING IDLING.

BELT SANDER  
141547

IMPACT ASSESSMENT: Machine is hazardous to operator when it is operated for more than 30 min per day. Machine contributes to noise exposures of nearby personnel.

NOISE SOURCES: Primary - Belt/stock vibration.

Secondary - Bearing/bearing support vibration.

POSSIBLE MITIGATION TECHNIQUES: • Partially enclose the sander.  
• Provide ventilated full enclosure.

RECOMMENDATION: Develop and install full ventilated enclosure to shield operator and minimize noise reduction.

EXPECTED BENEFIT: A 7- to 10-dB reduction in operator position sound levels during sanding, greater reductions during machine idling; approximate sixfold increase in permissible operational time; and elimination of machine noise contributing to noise exposure of nearby personnel.

EXPECTED COST: \$3000 per enclosure.



ABRASIVE CUTOFF SAW  
(NO LONGER IN CNSY SHOP)

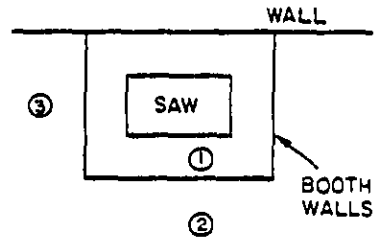

MEASUREMENT LOCATIONS  
(PLAN VIEW)

Criterion	Hourly Exposure (% Allowed)		Typical Use† (Hr)	Typical Operator Exposure (% Allowed)	Maximum Permissible Operational Time (Min)
	Operator Position (1)*	Operator Position (2)*			
DOD	117	2	1/2	159	51
EPA	311	3	1/2	156	19
OSHA	54	NIL	1/2	27	111

\*Assumes continuous use of saw.

†Estimated from discussions with shop personnel.

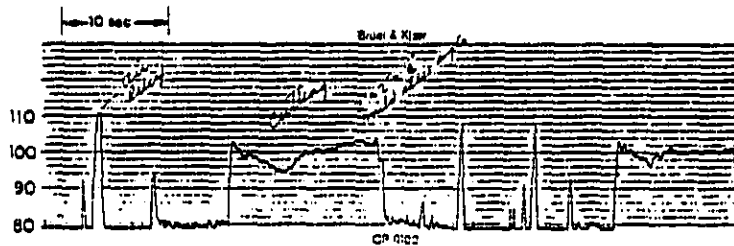

TIME HISTORY OF OPERATOR POSITION SOUND LEVELS

ABRASIVE CUTOFF SAW  
(NO LONGER IN CNSY SHOP)

IMPACT ASSESSMENT: Was hazardous to operator when it was operated continuously for more than 1/2 hr.

NOISE SOURCES: Primary - Blade vibration.

Secondary - Pneumatic exhaust and stock vibration.

POSSIBLE MITIGATION TECHNIQUES: • Damp blade.  
• Enclose blade.  
• Enclose stock.  
• Provide muffler at exhaust.

RECOMMENDATION: Not applicable, because machine has been removed. However, 3- to 5-dB noise reductions could have been obtained by use of the damping collar, and a muffler would have quieted the exhaust noise by 10- to 15-dB. Such treatment would have been adequate to about triple allowable operation time.

ABRASIVE CUTOFF SAW  
(REPLACEMENT FOR ORIGINAL UNIT)

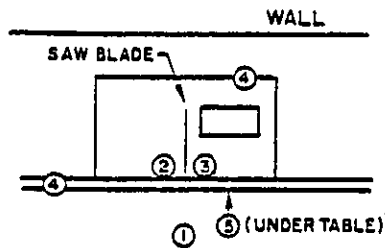

MEASUREMENT LOCATIONS  
AT REPLACEMENT SAW  
(PLAN VIEW)

Criterion	Hourly Exposure (% Allowed) at Operator Position*	Typical Use† (Hr)	Typical Operator Exposure (% Allowed)	Maximum Permissible Operational Time (Min)
DOD	4	1/2	2	Unlimited
EPA	6	1/2	3	Unlimited
OSHA	2	1/2	1	Unlimited

\*Assumes continuous use of saw, cutting occurring for 10% of use time, idling the remaining time.

†Estimated from discussions with shop personnel.

ABRASIVE CUTOFF SAW  
(REPLACEMENT FOR ORIGINAL UNIT)

IMPACT ASSESSMENT: Not hazardous because of limited use factor.

NOISE SOURCES: Primary - Blade vibration.

Secondary - Stock vibration.

POSSIBLE MITIGATION TECHNIQUES: • Damp blade.  
• Enclose blade.  
• Enclose stock.

RECOMMENDATION: No noise controls are recommended.

Report No. 4782

Bolt Beranek and Newman Inc.

## 5. SHIPYARD PROGRESS

The Charleston Naval Shipyard has investigated noise problems for many years. Although the sound levels in Shop 17 are much lower than in most industrial sheet metal shops, shop personnel are interested in reducing the noise. As a result of this interest, there have been a number of actions taken since the 1978 NAVSEA/EPA study. Unfortunately, there was no opportunity for CNSY personnel to discuss their concerns about these recommended treatments with BBN. If CNSY's concerns had been discussed with BBN, it is likely that the concerns expressed below could have been resolved and that the noise control treatments could have been implemented. The following summary, by machine, presents CNSY's recent actions:

- o Band Saw - The Shop has not installed any of the recommendations from the 1978 study. They think that only a booth (not the barrier shown in Fig. 3) is practical. Thus, they have constructed portable sound booths to use around the band saw. Unfortunately, the operator of the saw is still exposed to the noise. In March 1981, Mr. Pritchard indicated a willingness to try the barrier shown in Fig. 3. This type of barrier has been used successfully in other shops.
- o Friction Saw - The shop has tried a rubber mat on the stock table but the stock then did not slide as readily and this attempt was abandoned. The new numerically controlled machine is now used for many of these applications for which the friction saw had

been used. Thus, the friction saw is less of a problem now than in 1978.

- o Angle Grinder - The Shipyard has been unable to locate suitable mufflers. Due to the wide variety of work pieces, they think a new stock support is impractical. They think the damping blanket has merit. Portable sound booths have been constructed and are placed around the work bench while grinding is being performed. A grinding room was constructed using sound absorbing material on the inside walls and ceiling. All long duration grinding (2 hours or more) is done in this room.
- o Pneumatic Drill - The Shipyard has been unable to locate suitable mufflers.
- o Router - The Shipyard thinks the stock support system is impractical due to the diversity of work pieces and the need for cleanliness in the nuclear work. In March of 1981, Shipyard personnel indicated the router is not used very much.
- o Square Shears - The Shop concurs on the clamp devices. They have installed a control system on S.N. 102504 and are considering similar installations on the other shears. The exhaust muffler was installed on S.N. 127987. The shear area has been enclosed on three sides by 8' high partitions to reduce the noise levels in the adjacent work areas. An acoustical ceiling has been installed over the shear

area. One-half inch thick rubber matting has been placed on the back side of the shears to reduce the noise of the cut materials falling to the floor.

- o Belt Sander - The Shop thinks that the total enclosure is impractical due to frequent belt changes and maintenance that is required. Our experience is that although it appears cumbersome, such enclosures have worked on other sanders.

In addition to the noise control treatments for the machines, the Shop has completed the following:

- All of the openings in the west wall between Shop 17 and the Boiler Shop have been caulked and sealed. The wall was also covered with an acoustical material. This was done in an attempt to reduce the annoyance due to the sounds coming from the Boiler Shop.
- All work benches were covered with a sound dampening material but the workers do not like the "feel" of the material when they hammer on it.
- Roof mounted fans have been modified to reduce the background noise levels in the shop. This was done more to reduce annoyance than for hearing conversation reasons.
- A few sound absorption panels have been placed on the north wall in the work bench area in an effort to reduce the reverberent sound fields. Additional panels will be needed to achieve any significant reduction in the reverberant sound field.



- The new Warner Swasey W-3050, Navy 10 181-142086 punch press has been enclosed on three sides to reduce the sound levels in the adjacent work areas.

In addition to these efforts, the Shop plans the following actions:

- A continuation of their effort to procure mufflers for the pneumatic tools on hand. The mufflers must not be bulky, interfere with the operator or affect the performance of the tool.
- Replacement of noisy tools with quieter ones.
- Ensuring that all new machinery purchases do not exceed the current noise limits.

## APPENDIX A: DISCUSSION OF TECHNICAL TERMS

This report uses several technical terms to describe the noise emissions of individual machines, the noise exposures caused by these machines, and other acoustical parameters. Some of these terms are confusing; others are esoteric. This Appendix provides comparisons and definitions of the more important technical terms used in this report.

## A.1 Impulsive vs Continuous Noise

Impulsive sounds are sharp bursts of noise; continuous sounds are more ongoing. The distinction between the two noises is critical in how they are measured and described.

Impulsive noises can be measured correctly only with equipment capable of detecting and indicating the very rapid pressure changes involved. Impulsive noises are characterized by their peak sound pressure level,  $L_p$ , which describes (logarithmically) the maximum sound pressure of the noise pulse. Full characterization of an impulsive noise requires a description of how the impulse decays to a point of insignificance.

Continuous noises are characterized by their sound level,  $L_A$ , which takes into account both the sound pressure of the noise and its spectral content, or frequency composition. Full characterization of a continuous sound often requires an explanation of how the sound level varies with time, as few continuous sounds have a steady level for very long.

## A.2 Average Sound Levels

Continuous sounds are seldom constant in level, and so an averaging technique must be employed to enable the sound to be characterized with a single number. Different techniques are used for averaging, depending on the purpose of the measurement.

The true average of the sound pressures is usually employed to describe the entire time history. The sound pressures are weighted according to their proportionate duration. The term L-equivalent,  $L_{eq}$ , is given to this time average, which is described mathematically by the equation:

$$L_{eq} = 10 \log \frac{1}{T} \int_0^T \frac{p^2(t)}{p_0^2} dt, \quad (A.1)$$

where  $p(t)$  is the time-varying pressure, and  $p_0$  is a reference pressure of  $20\mu$  pascals (Pa).

$L_{eq}$  is most often used for describing noise emissions (see Sec. A.3).

The averaging procedure used to describe the hazard of a time-varying sound ignores sound levels below a particular cut-off sound level. The averaging procedure also weights the sound levels involved by both intensity and duration. Essentially, an exposure rating (or noise dose),  $E$ , is computed from the equation:

$$E = \frac{C_1}{T_1} + \frac{C_2}{T_2} + \dots + \frac{C_n}{T_n}, \quad (A.2)$$

where C represents the time of exposure to a particular sound level, and T represents an allowable time of exposure to that sound level. The allowable time is calculated from the equations:

$$T = \frac{960}{2^{(L_A - 80)/4}}, \text{ for the DOD-based criterion, or} \quad (A.3)$$

$$T = \frac{480}{2^{(L_A - 85)/3}}, \text{ for the EPA criterion, or} \quad (A.4)$$

$$T = \frac{480}{2^{(L_A - 90)/5}}, \text{ for the OSHA criterion.} \quad (A.5)$$

T is infinite for sound levels below the cut-off sound level. A noise dose of one corresponds to an average sound level equal to the cut-off sound level.

The exposure rating can be converted to a percentage by multiplying E by 100.

E can be converted back into an average sound level,  $L_{\text{AVERAGE}}$ , according to the formula:

$$L_{\text{AVERAGE}} = \frac{X \log E}{\log 2} + Y. \quad (A.6)$$

X is 4, 3, or 5, and Y is 80, 85, or 90, respectively for the DOD, EPA, and OSHA criteria. The  $L_{\text{AVERAGE}}$  is most often used for describing noise exposures (see Sec. A.3).

Note:  $L_{\text{AVERAGE}}$  is undefined for  $E = 0$ , and it will often compute to values much less than the  $L_{\text{eq}}$  of the sounds involved, particularly if the actual sound level is below  $Y$ , the cut-off sound level, and if  $E$  is particularly low.

### A.3 Noise Exposure vs Noise Emission

The noise output of a machine, measured at a specific distance from the machine under specific room conditions, is a measure of the noise emission of the machine. Noise emissions may vary with position around a machine and will almost certainly vary with distance from the machine. Noise emissions can be used to help predict the sound levels at a particular location in a particular space when various combinations of machines are operating. Noise emissions are described by  $L_{\text{eq}}$ .

The term noise exposure refers only to the sounds received by an individual. Noise exposures are described by either the noise dose, percentage equivalent of the noise dose, or the  $L_{\text{AVERAGE}}$  (see A.2). The latter is used most often when determining noise reduction requirements, the former term when assessing whether the exposure is hazardous.

### A.4 Direct and Reverberant Sound Fields

A machine is usually noisier indoors than outdoors because of the reverberation or reflection of the sound indoors. This effect is more marked at greater distances from the machine, where the sound levels directly radiated by the machine are less dominant. The spatial region close to a noise source where sounds emanating from a machine dominate the measurements is termed the *direct sound field* of that source. That spatial

area where the effects of reflection dominate is called the *reverberant sound field*. The spatial arrangement of these sound fields can be predicted and described, and it forms an important part of noise exposure prediction analysis. Reverberation can have dramatic effects, especially for noise sources generating continuous sound, because sound energy is continuously pumped into the space, and, in a short period of time, a fairly constant and stable density of acoustic energy fills the space. This is contrasted with sources generating impulsive sounds, the total acoustic output is made in a short period of time, and the resultant sounds decay in accordance with the reverberation time of the space. Clearly, for continuous sounds, factors that influence reverberation are critical.

Report No. 4782

Bolt Beranek and Newman Inc.

APPENDIX B

ABSTRACTS AND SUMMARIES OF ARTICLES AVAILABLE IN THE  
OPEN LITERATURE ON NOISE EMISSIONS AND  
CONTROL FOR EQUIPMENT SIMILAR TO  
THAT USED IN SHEET METAL SHOP 17

B.1. Existing and Potential Noise Reduction Technology for the  
Fabricated Metal Products Industry - Task Report J6331

Authors: E.P. Bergmann  
IIT Research Institute under sponsorship of the  
U.S. Environmental Protection Agency

Date: July 1975

Source: Contract EPA-68-01-2234

*Abstract:* Machinery noise level data and noise control treatment information were gathered by the author from 151 articles, papers, abstracts, and OSHA noise file cards. The data and information were summarized on data sheets and included in this report. No information was included for band saws, routers, or nibblers. Data and information provided for presses, pneumatic equipment, and shears are summarized herein.

*Control Techniques and Measurements Reported:*

• *Pneumatic Equipment*

1. Enlarged exhaust orifice and muffled air exhaust for pneumatic grinder. Before treatment, 105 to 107 dBA. After treatment, 89 to 93 dBA.
2. Plywood booth lined with 3/4-in. to 1-in. absorptive material. Includes a transparent door and rubber of plastic covered slotted openings to allow access by operator's arms to hand-held grinder. Before treatment, 102 to 104 dBA at grinding station. After treatment, 86 to 87 dBA.
3. A disc grinder used to grind welds was replaced with a belt sander. Before replacement, 105 dBA at operator's ear. After treatment, 93 dBA.



Existing and Potential Noise Reduction Technology - Page 2

• *Shears*

1. Rollers were covered with "deadening sleeves" and filled with "damping material." Before treatment 92 to 107 dBA. After treatment, 9 to 14 dB less.
2. Four mufflers were installed to reduce the noise produced by the exhaust mechanism from 96 to 90 dBA.

• *Presses*

1. Noise control treatment options and achievable reductions listed on the attached table.
2. Enclosure constructed for a 20-ton press consisted of a 2 x 4 frame covered with 3/4-in.-thick plywood and lined with 1-in.-thick foam with a 1 lb per sq ft lead septum. Openings were provided for material input, parts and scrap output, and heat removal. The heat removal openings were baffled, and louvered position of baffles said to make a "great difference" in the noise reduction achieved. Sound level measurements made 6 ft in front of and 6 ft behind the press operating at 600 strokes per min yield 98 dBA before and 86 dBA after the treatment.
3. Vibration isolation and damping material on outside of handling chutes reduced the noise of an 800-ton hydraulic press from about 100 dBA to about 94 dBA.
4. Sources were identified as pipework, shakers, hydraulic system, and gears. Leaded vinyl was added to inside of covers that fit over the die head area, and the feed and takeoff openings were reduced in area. Sound level reduction achieved was 6 dB.

Existing and Potential Noise Reduction Technology - Page 3

5. A complete enclosure was constructed of 16-gauge stainless steel and viscoelastic damping compound. Windows were provided of double-glazed safety glass mounted in rubber molding. Ventilation system also provided. Before treatment, 97 dBA. After treatment, 81 dBA.
6. A complete enclosure was installed, the press was mounted on rubber isolators, the stock entrance and access panels were sealed, and a muffled ventilation system was provided. Twenty ft from the press the noise level was reduced from 98 to 71 dBA.
7. A 60-ton press enclosure was constructed of galvanized steel lined with 4-in.-thick sound absorptive material. Before treatment, 103 dBA. After treatment, 83 dBA.
8. A sound absorptive enclosure reduced punch press sound levels from 114 to 86 dBA at the operator's ear.
9. A partial enclosure and rubber isolators reduced punch press noise levels from 93 to 80 dBA.
10. An enclosure reduced punch press noise from 99 to 87 dBA at 3 ft.
11. A four-sided enclosure (without roof) constructed of 4-in. thick "IAC Noiseshield Panels" reduced the sound level at the operator's station of a 125-ton punch press from 97 to 89 dBA. It is not clear whether this is a press enclosure or an operator enclosure.
12. Punch press part ejector sound level reduced from 104 to 89 dBA by tilting press 35° from vertical plain, reducing air pressure, and changing ejector from continuous to intermittent operation.

TABLE B.1. NOISE TREATMENT OPTIONS

Subsystem	Treatment	Reduction, $\Delta$ dB
Frame	Rigid, all steel weldment	Unknown
Clutch	Pneumatic or hydraulic	Unknown
Ram	Damper for punch breakthrough	5
Press	Reduce press loading by one-half	6
Punch	Replace single shear with double shear	4-5
Die	Single step to multiple step	5
Stripper plate	Replace metallic plate with plastic plate	4
Workpiece supply	Positive guide to coil loop	10
Workpiece discharge	Avoid pneumatic discharge	Unknown
Press	Enclosure	20-25

B.2 Origins of Punch Press and Air Nozzle Noise

Authors: S. Sahlin and R. Langhe  
Swedish Institute of Production Engineering Research  
Göteborg, Sweden

Date: November-December 1974

Source: *Noise Control Engineering* 3, No. 3, pp. 4-9  
(also *InterNoise 74 Proceedings*, pp. 221-224)

*Abstract:* Noise generation in a punch operation is said to depend on the shape of the force-time diagram for the press frame and the relative velocity of machine parts ramming into each other. The discharge noise of compressed air used to move parts is also said to be a major noise source. Methods to reduce press noise are discussed. Reduced noise level air nozzles with adequate performance are discussed and data are presented.

*Noise Sources:* When punching thin, brittle sheet metal, it is said that the back spring of the frame (often the punch breaks through the material) causes most of the emitted noise. In crank presses, machine parts ramming into each other to transfer forces from one to the other are sources of noise. Another, sometimes major, noise source is the compressed air discharge.

*Measurements Reported:* Representative time history diagrams are illustrated for press force, tooling acceleration, and sound pressure level. Octave band SPL data are given for four low noise level nozzles and a common nozzle. Measurement details are not provided.

*Control Techniques:* Several methods are conceptually described to change a press's force-time diagram and thereby reduce its impact noise, such as cutting the punch at an angle, and adding a polymeric disc to the tool to reduce press accelerations. The use of springs and cams is conceptually discussed to reduce

Origins of Punch Press and Air Nozzle Noise - Page 2

the acceleration of machine parts that ram into each other. The use of low-noise-level nozzles, reduced pressure, the most favorable direction, tool surface modification, and intermittent operation is encouraged to reduce the noise associated with compressed air discharge. In addition, the cost of compressed air blowing is said to be reduced by 80% using an intermittent rather than continuous system.

*Sound Level Reductions:* Mid- and high-frequency sound level reductions of 10 to 15 dB are shown in Fig. B.1 for identified test nozzles that produce the same force as the reference (common) nozzle configuration. Sound as a function of force (without units) is also illustrated for the identified test nozzles. Measurement details not provided.

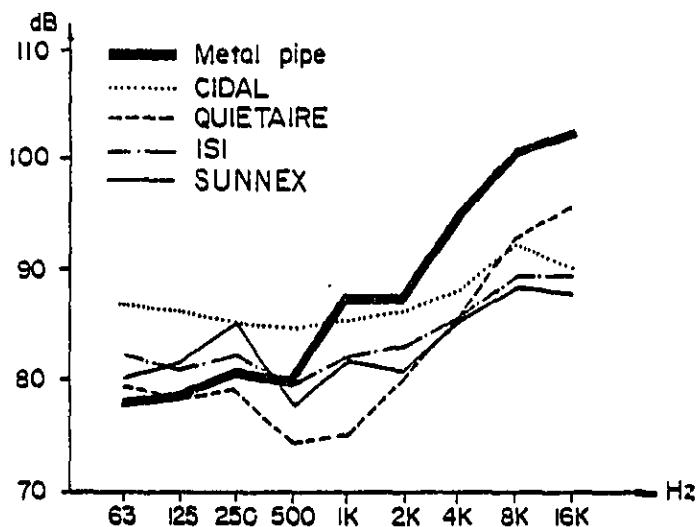

FIG. B.1. OCTAVE BAND ANALYSIS OF TEST'S BEST NOZZLES THAT PRODUCE SAME FORCE AS METAL PIPE.

B.3 Press Noise Reduction

Author: A.M. Petrie  
Paisley College of Technology  
Scotland, U.K.

Date: August 1975

Source: *InterNoise 75 Proceedings*, pp. 311-314

*Abstract:* Noise control results are reported and briefly discussed for university tests of a 15-ton punch press operating at 140 strokes per min. Parameters studied and reported -- using 1/8- and 1/16-in.-thick mild steel -- are: enclosure open area, punch impact velocity, punch/die clearance, shear angle, and shear area. It is concluded that significant noise level reductions can be achieved with partial enclosures, minimizing punch impact velocity, changing shear angle, and minimizing punch/die clearance.

*Noise Sources:* The following noise sources are mentioned but not individually addressed in this study: impact associated with die operation, turbulence noise from air exhaust, component impact, feed mechanism, clutch and brake mechanism, and vibration of parts attached to the press. Peak noise from the entire press is addressed.

*Measurements Reported:* The dependence of peak A-weighted sound level -- observed at the operator's position for each of the parameters studied -- is reproduced in Figs. B.2 through B.7.

*Control Techniques:* Control techniques for which results are reported are: complete and partial enclosures with sound-absorptive lining, reductions in punch velocity, changing shear angle, and minimizing punch/die clearances. The effect of material thickness, 1/8- vs 1/16-in.-thick mild steel, is also shown.

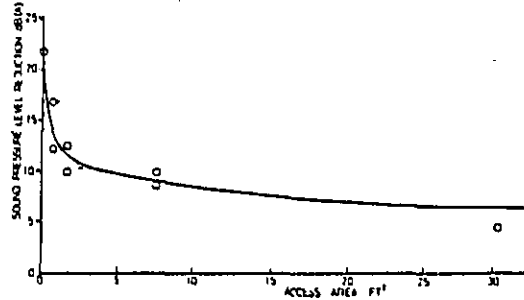

(B) Fig. 2 DEPENDENCE OF ENCLOSURE ATTENUATION ON FRONT ACCESS AREA

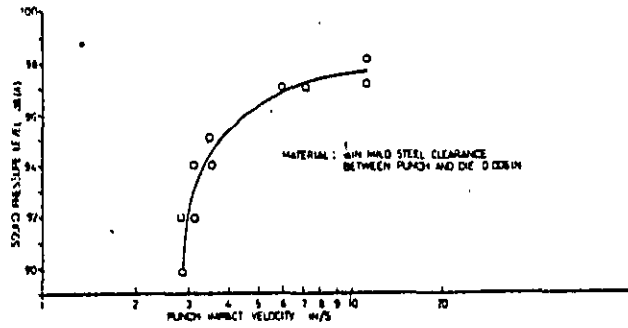

(B) Fig. 3 EFFECT OF PUNCH IMPACT VELOCITY UPON SOUND PRESSURE LEVEL

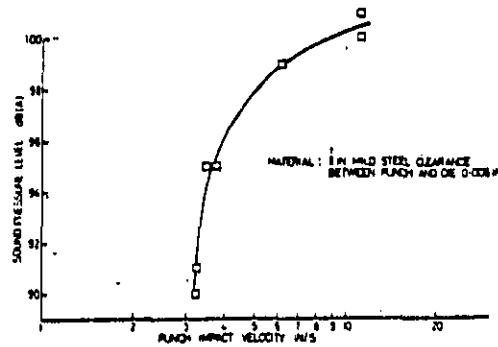

(B) Fig. 4 EFFECT OF PUNCH IMPACT VELOCITY UPON SOUND PRESSURE LEVEL

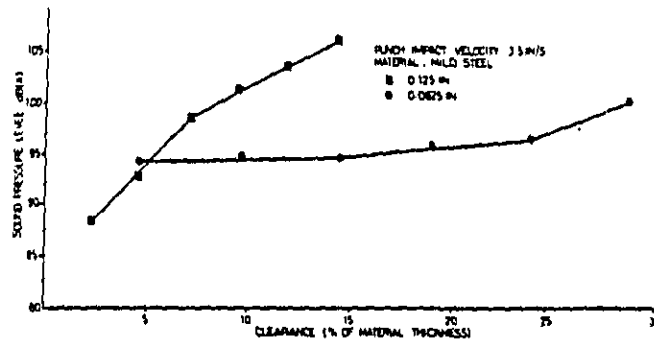

(B) Fig. 5 EFFECT OF PUNCH/DIE CLEARANCE UPON SOUND PRESSURE LEVEL.

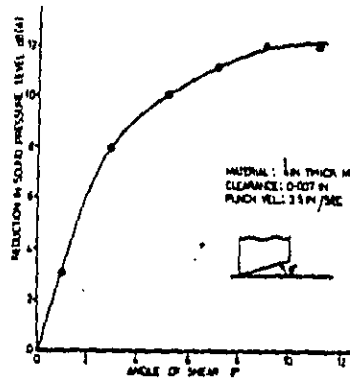

(B) Fig. 6 EFFECT OF ANGLE OF SHEAR UPON SOUND PRESSURE LEVEL.

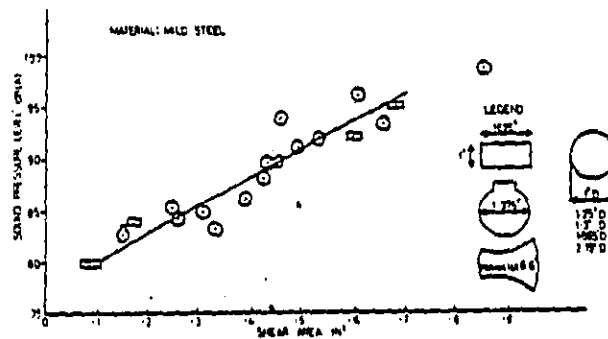

(B) Fig. 7 SOUND PRESSURE LEVEL VS SHEAR AREA.



Press Noise Reduction - Page 2

*Sound Level Reductions:* Differences in peak A-weighted sound level at the operator's position, shown in Figs. B.2 through B.7, are up to 20 dB. The effects of the parameters on hole quality are not discussed.

B.4 Impact-Induced Industrial Noise

Author: O.A. Shinaishin  
Environmental Protection Agency  
Washington, D.C.

Date: Winter 1974

Source: *Noise Control Engineering* 2, No. 1  
(See also: *InterNoise 72 Proceedings*, pp. 243-248, "On Punch Press Diagnostics and Noise Control.")

*Abstract:* Brief conceptual discussion of the acquisition and analysis of noise, vibration, and position data for the purpose of identifying noise sources in impact machines. Conceptual methods to reduce machine noise at the source are mentioned. Practical insights and field experience are not provided.

*Noise Sources:* The impulsive sound generated by power presses is said to result mainly from impulses and impacts with little contribution from other sources, such as rotating parts, gears, and bearings. At low generating speeds (<300 rpm), the impact noise is said to be caused by the forces of stamping, whereas at higher speeds (>400 rpm) impacting of the stripper plate, for example, becomes significant.

*Measurements Reported:* Waveform, frequency-time, spectrum, and cross-correlation data are illustrated for sound and vibration measurements on a punch press. Sound pressure level data are also illustrated, showing the effect of die shearing, speed of operation, plate damping, and plate impact velocity. Measurement conditions, measurement position, meter damping, and machine identification are generally not provided.

*Control Techniques:* Noise reduction techniques are discussed conceptually in terms of changing the forces generated by the machine, eliminating the force transmission to radiating parts, and reducing the vibration and radiation capability of machine elements.

*Sound Level Reduction:* Reduction of stamping force by use of a slanted die is shown to reduce the noise produced by a blanking press, although product quality may be affected (see Fig. B.8). Laboratory tests show that the noise produced by impacting layers is reduced when the impact velocity is reduced or when lead layers are laminated to the plates.

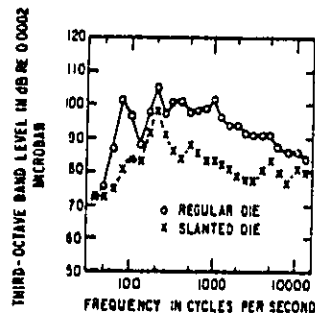

SOUND PRESSURE LEVELS OF BLANKING PRESS

FIG. B.8. EFFECT OF DIE SHEARING ON SOUND LEVEL.

B.5 Sweden's New Approach to Noise Control in Industry:  
Noise Control in Mechanical Industry

Author: Per-Ake Berg  
Ingemansson Associates  
Gothenburg, Sweden

Date: May 1978

Source: *InterNoise 78 Proceedings*, pp. 137-144

*Abstract:* Swedish noise abatement programs are listed and various noise reduction measures put into practice in the mechanical industry are discussed. Measures used to control noise from presses and hand-held grinders are summarized below.

*Noise Sources:* Component noise sources not discussed.

*Measurements Reported:* Sound pressure level measurements with and without noise control measures are illustrated. Measurement details not provided.

*Control Techniques:* Hydraulic dampers mounted into the tool area are said to reduce the impulsive force and noise produced by a punch press operation. Grinding noise is said to be reduced by (1) clamping the workpiece (plate) in a damping fixture, or (2) using double- rather than single-roller mounting supports for the workpiece.

*Sound Level Reductions:* The equivalent sound level of the punch press was reduced from 95 to 89 dBA, and it is said that the impulse level was reduced as much as 10 dB. The damping fixture discussed reduced the grinding sound level 4 dB for 1-mm-thick plate and 12 dB for 9-mm-thick plate. The double-roller mounting support reduced the grinding sound level about 6 dB compared to the single-roller support.

B.6 American Can Company's "Close-In" Noise Control  
Enclosure Program

Author: W.H. Croasdale  
American Can Company  
Fairlawn, N.J.

Date: May 1978

Source: *InterNoise 78 Proceedings*, pp. 427-432

*Abstract:* Two concepts for automatic-press enclosure are discussed. Enclosure materials, some design information, and before/after sound pressure level measurements near the press are provided for a variety of presses used in the can industry.

*Noise Sources:* Press components that produce noise are not identified.

*Measurements Reported:* Octave band and A-weighted measurements made near the presses and then averaged are illustrated for both before and after enclosure installation. Measurement conditions, meter response, etc. are not provided.

*Control Techniques:* Control techniques employed are (1) small partial enclosures constructed of transparent material and attached directly to the press at the die area and at other moving parts, and (2) custom designed, close-in, total enclosures constructed of steel.

*Sound Level Reductions:* Tests of the small partial enclosures indicate average sound level reductions of 3 to 5 dB. Reductions of 20 to 28 dB are reported for the total enclosures installed at four different machine types.

B.7 A Quieter Band Saw Blade

Author: M.S. Bobeczko  
Moderator of Session II

Date: June 1976

Source: *Proceedings of the Workshop on the Control of Metal Sawing  
Noise in the Aluminum Industry*, p. C-2  
The Aluminum Association  
750 Third Avenue, New York, N.Y.

*Abstract:* Brief announcement that the American Saw and Manufacturing Company has developed a new band saw blade, called the "Vari-Tooth," which is said to produce less noise than previous blades.

*Noise Sources:* Not addressed.

*Measurements Reported:* A-weighted sound levels are reported for measurements 3 ft from a Marvel No. 81 vertical band saw cutting a 6-in. x 16-in. structural steel I-beam, using a conventional 6-tooth blade and a 6/10 "Vari-Tooth" blade.

*Control Techniques:* The blade's gullet depth, tooth pitch, and set angle are varied.

*Sound Level Reductions:* Sound level reductions of 20 dB while cutting the beam web and 2 dB while cutting the beam flange are reported.

B.8 Reducing Pneumatic Tool Noise

Authors: R.A. Willoughby and E. Parker  
Ingersoll-Rand Co.  
Athens, Pa.

Date: September 1973

Source: *Plant Engineering*, 6 September 1973, pp. 109-111

*Abstract:* This short article describes in layman's terms the availability of mufflers for existing and new pneumatic hand tools. The mufflers are designed to reduce air exhaust noise only. The tool noise produced by grinders and chippers, for example, must be controlled by other methods. Wooden workbenches are said to help reduce noise in some cases.

*Noise Sources:* Noise that radiates from the exhaust of pneumatic tools is addressed.

*Measurements Reported:* Octave band sound pressure level data are reported on the exhaust noise for a muffled and unmuffled air motor, small hand grinder, and impact wrench. Measurement conditions and location not given.

*Control Techniques:* Three methods are described to reduce exhaust noise.

1. Piped-away systems to carry exhaust to a remote muffler or manifold.
2. Internally installed mufflers for new tools where space permits.
3. Retrofit kits that include an exhaust air collector, a hose, and a muffler.

*Sound Level Reductions:* Fractional horsepower tools, such as screwdrivers and drills, seldom need exhaust muffling to meet OSHA noise regulations.

Reducing Pneumatic Tool Noise - Page 2

Tools ranging from 1 to 1-1/2 hp can be muffled so that the exhaust noise is acceptable with little or no loss in tool efficiency. Tools operating a 2 hp and above may require piped-away exhausts to meet the 90 dBA/8-hr regulation without reducing tool efficiency.



B.9 A Systems Approach for Control of Punch Press Noise

Authors: J.R. Bailey, J.A. Daggerhart, and N.D. Stewart  
North Carolina State University  
Raleigh, N.C.

Date: September 1975

Source: American Society of Mechanical Engineers  
Paper No. 75-DET-49  
New York, N.Y.

*Abstract:* Several punch presses, ranging in capacity from 25 to 60 tons, were used to develop the illustrated relationships between sound level and workpiece area, speed, ram acceleration level, tool clearance, use of shear punches, hole size, and material hardness. Noise reductions obtained using exhaust mufflers and an ejector silencer are shown. The use of a systems approach is suggested, and a flow diagram is illustrated as an aid in the development of noise control designs. A brief literature review is included.

*Noise Sources:* Noise sources discussed include exhausts from air clutches, brakes, and part ejectors and the workpiece and the press itself.

*Measurements Reported:* Oscilloscope traces of punch press impact sounds are shown. Reductions of air exhaust peak noise are illustrated for mufflers and nozzle redesign. Six graphs are provided showing peak sound pressure level vs workpiece area, machine rate, ram acceleration level, tool clearance, use of shear punches, and hole size/material hardness. Measurement locations are not specified.

*Control Techniques:* Various noise control techniques are said to have been demonstrated in the experimental program reported in this paper. The systems approach suggested emphasizes, first, the need to identify the machine or

A Systems Approach for Control of Punch Press Noise - Page 2

machines and then the machine component or components that dominate the sound field of concern. Examples are given which, at least conceptually, indicate that noise reduction can be achieved by reducing air discharge turbulence, impact velocity, and punch acceleration.

*Sound Level Reductions:* Reductions of 10 to 20 dB in peak sound pressure levels are shown. Measurement locations and conditions are not provided.

B.10 A Review of Noise and Vibration Control for Impact Machines

Author: R.D. Bruce, Consultant  
Bolt Beranek and Newman Inc.  
Cambridge, Mass.

Date: October 1972

Source: *InterNoise 72 Proceedings*

*Abstract:* Noise control treatment concepts applicable to punch presses are reviewed and approximate noise reductions that might be achieved are stated. Some data are presented. Ten punch press manufacturers were questioned about sound level specifications and noise control designs. The results of this survey are summarized.

*Noise Sources:* Identification of individual components is not emphasized in this paper.

*Measurements Reported:* Punch press sound levels range from 88 to 112 dBA at the operator's position. Measurements before and after installation of enclosures illustrated meter dynamics and measurement conditions not reported.

*Control Techniques:* The use of sound absorptive material to reduce noise levels in press rooms is discussed, and an example is provided. Partial and full enclosures are also discussed and examples provided. Other treatments mentioned include vibration isolation, damping materials, barriers, mufflers for air exhausts, operation of the punch in shear, and alternate methods to knock out parts.

*Sound Level Reductions:* Sound absorptive material applied to a press room reduced reverberant field sound levels by 9 dB and close-in operator position sound levels by 2 to 3 dB. A partial enclosure of a 22-ton punch press

reduced close-in sound levels by 10 dB. A 20-dB sound level reduction is reported using a full enclosure for a multislid punch press. It is stated that 30 dB of insertion loss can be achieved with a large enclosure around the entire press. Operation of the press in shear can sometimes reduce sound levels by about 15 dB.

B.11: Noise-Reducing Punch-Press Card

Author: R.S. Florczyk  
Safety Consultant  
Chicago, Ill.

Date: October 1973

Source: *Plant Engineering*, 18 October 1973, pp. 158-159

*Abstract:* A basic housing design is described and illustrated that can be custom-built to fit most automatic punch presses (precision types to 35-ton capacity). Methods to reduce the noise associated with mechanical and aerodynamic parts knockout are mentioned.

*Noise Sources:* The ram-die area of the press and the knockout operation are addressed in this paper.

*Measurements Reported:* Average costs for the basic housing described are said to average about \$200. Observed noise reductions range from 5 to 20 dB.

*Control Techniques:* A housing or collar design is illustrated to fit around the ram-die area of most presses. Experience is claimed for a variety of presses of less than 35-ton capacity. The housing is constructed of sheet aluminum, sheet lead, sound absorbing material, clear plastic sheet, and miscellaneous hardware. Mechanical knockout noise is said to be reduced by applying hard rubber pads to those areas of the ram that strike other metal. When air ejection is used, sound levels can be reduced by reducing air pressure and volume. The use of a small nozzle and a pressure regulator is suggested.

Noise-Reducing Punch-Press Card - Page 2

*Sound Level Reductions:* A noise level reduction of 5 to 10 dB can be expected by applying hard rubber pads to contact areas of the knockout ram. Installation of the housing has resulted in sound level reductions of 5 to 10 dB, depending on the press and material being stamped.

B.12 A Practical Approach to Punch Press Quieting

Authors: C.H. Allen and R.C. Ison  
Bolt Beranek and Newman Inc.  
Cambridge, Mass.

Date: July-August 1974

Source: *Noise Control Engineering* 3, No. 1

*Abstract:* Eight principal noise sources are rank ordered based on the authors' study of presses ranging in size from a few tons to 200 tons. The results of vibration level and sound pressure level measurements are compared. A close-in mock-up enclosure for a 50-ton automatic press is described, and the sound level reduction (13 dB) is discussed.

*Noise Sources:* Sources of primary importance are rank ordered as follows:

1. Impacts associated with die operation.
2. Turbulence noise caused by air injection.
3. Metal-to-metal impacts of parts entering or leaving the press.
4. Start and stop impact of automatic feed mechanisms.
5. Vibration of flywheel guard and other sheet metal parts fastened to the press.
6. Vibration of sheet metal stock being fed into the press.
7. Clutch and brake mechanisms on the drive shaft.
8. Vibration of the surfaces of the press itself.

Items 1, 2, 3, 5, and 8 are discussed in terms of sound level contributions and noise control concepts.

A Practical Approach to Punch Press Quieting - Page 2

*Measurements Reported:* Calculated and measured octave band sound pressure levels at the operator's position are given for total press noise, air discharge noise, and for several press components. Measurement conditions and meter damping are not discussed.

*Control Techniques:* A small enclosure surrounding the dies, the ram, the cross feed, the delivery chute, and a short section of the feed plate is described for a 50-ton automatic press. A photograph and sketch of a mock-up enclosure is provided along with before and after measurements. The importance of rugged construction is emphasized. The need to vibration isolate all sizable sheet metal parts and covers is mentioned. Replacement of the discharge duct impact sensor with a magnetic or light sensing device is also mentioned.

*Sound Level Reductions:* A 13-dB reduction in sound level at 1 m from the press is reported for the small mock-up enclosure. The press was operated at its normal rate of production without any functional interference. The reduction was limited by radiation from the flywheel cover and scrap chute. The enclosure sketch and observed reduction are illustrated in Figs. B.9 and B.10. Additional data are given in the paper.



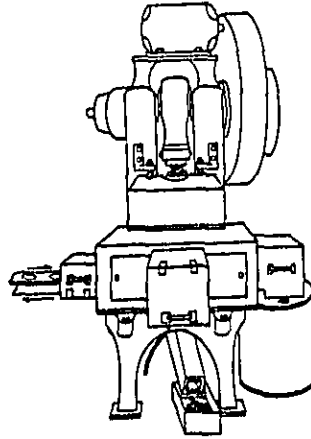

FIG. B.9. 50-TON PRESS WITH NOISE ENCLOSURE.

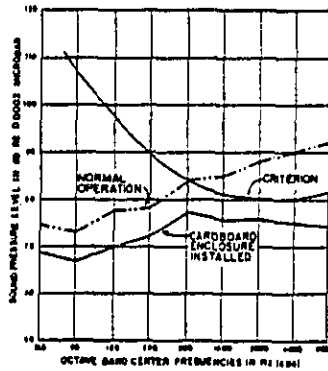

FIG. B.10. SPL, 30 in. FROM 50-TON PRESS WITH AND WITHOUT CARDBOARD ENCLOSURE.

B.13 Noise Control of a Friction-Cutting Band Saw for Hard Metals

Authors: A. Schwartz and M. Schwartz  
Acoustical Consultants Ltd.  
Haifa, Israel

Date: March 1977

Source: *InterNoise 77 Proceedings*, pp. B310-B313

**Abstract:** Brief discussion of apparently successful noise control treatments installed at a friction-cutting band saw used to remove the tips of hard-metal turbine blades. Minimum engineering data or operating experience included. Band saw not described or identified. Purpose of treatment was to reduce noise exposure of operator.

**Noise Sources:** Noise sources/paths mentioned include the saw blade, table transmission, sheet metal machine surfaces, machine covers, and the enclosure ventilation system.

**Measurements Reported:** Data are reported in terms of A-weighted sound levels and octave band sound pressure levels measured near the operator's position and at 10 ft before and after installation of the treatments. The machine was located in a manufacturing hall the size and acoustic conditions of which are not described. Reported data measured at 10 ft are provided in Fig. B.11.

**Control Techniques:** Five steps were taken to reduce the operator's noise exposure:

1. Enclose the saw path.
2. Provide a flexible enclosure for the saw-table transmission.
3. Damp sheet-metal machine surfaces.
4. Improve sealing of machine covers.
5. Provide operator with ear protectors.

Noise Control of a Friction-Cutting Band Saw for Hard Metals - Page 2

A ventilated and partially transparent enclosure was also installed to reduce further the band saw sound levels at other worker positions. The transparent section of the enclosure was constructed of 0.2-in.-thick, 1.4-psf material described as "Kinetics" acoustical curtain. Photographs of the enclosure are included in the paper.

*Sound Level Reduction:* Near the operator position (inside the enclosure) the reported sound level was from 110 to 84 dBA. Why the sound level before the enclosure was 110 dBA near the operator's position and 10 ft from the machine is not explained.

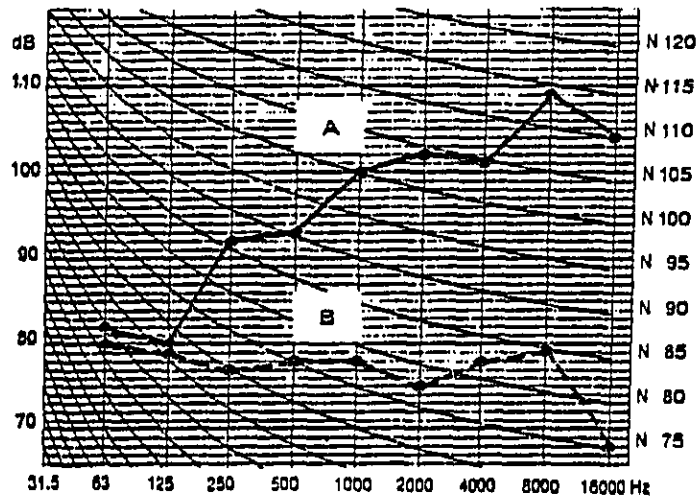

FIG. B.11. THE RESULTS OF THE ACOUSTIC MEASUREMENTS BEFORE (A) AND AFTER (B) THE ACOUSTICAL ARRANGEMENTS.

B.14 Effectiveness of Isolators in Reducing Vibration of a 250-Ton  
Blanking Press

Author: R.A. Young, Editor  
*Pollution Engineering*

Date: December 1974

Source: *Pollution Engineering*, December 1974, pp. 32-33

*Abstract:* Vibration level measurements are reported for a 250-ton blanking press, which was first bolted to its foundation and then isolated from its foundation. Based on significant reductions in vibration levels, it is inferred that sound levels in the press room were also reduced.

*Noise Sources:* The press structure and press induced vibration of the room's floor and roof.

*Measurements Reported:* Vibration level measurements of the foundation, foundation plate, press structure, and a building column are reported. Noise level measurements are not reported.

*Control Techniques:* Vibro/Dynamics Series BFM-1230 micro/level isolators were installed below the press to reduce the transmission of vibration.

*Sound Level Reductions:* Reductions in peak vibration levels are reported to range from 15 to 30 dB. Sound level reduction data are not reported, but the author implies that the reduction in vibration has a significant effect on reducing noise.

B.15 Noise Control Solutions for the Metal Products Industry

Prepared by: Richard K. Miller & Associates, Inc.  
Atlanta, Ga.

Date: 1977

Source: Publication prepared for the Southeast Acoustics  
Institute, Atlanta, Ga.

*Abstract:* General approaches to controlling the noise of 34 machines and operations used in the metal products industry are reported. The report information is from the authors' literature search and noise abatement experience.

*Sources, Control Techniques, and Measurements Reported:*

• *Presses*

1. Press noise generating mechanisms are classified as vibration of the press structures induced by the impact forces; mechanism noise (clutches, gears, etc.); and material handling (ejectors, conveyors, etc.).
2. Straight side presses are said to be inherently less noisy than open back inclined presses.
3. Presses selected with 50% to 100% excess capacity are said to produce less noise than presses operated at full capacity.
4. The press force can be reduced if the lower face of the punch is inclined, or, in an operation involving the punching of several holes at one stroke, the force can be reduced by using stepped punches. An 8-dB reduction is reported with the use of a slanted die.

5. Operations on soft material, such as brass and aluminum, are less noisy than operation on hard materials, such as stainless steel.
6. Damping has little potential for reducing the press noise radiated by heavy structural elements. Damping can be effective in reducing resonant vibrations and radiated noise of lightweight elements, such as flywheel guards.
7. The noise produced by compressed-air parts-ejection systems can be reduced by various techniques.
  - a. The use of commercially available air discharge thrust silencers.
  - b. The reduction of air pressure and "on-time" to the minimum required for reliable ejection; energy consumption is also reduced.
  - c. Replacing the air discharge nozzle with a few strategically located holes in the die and connected to the compressed air supply.
  - d. Careful aiming of the nozzle, so that the air jet impinges on flat rather than slotted surfaces can reduce noise by 10 dB.
  - e. The use of commercially available vacuum devices rather than compressed air.
  - f. The installation of a partial enclosure over the die space.
  - g. The use of "push-through" ejection, so stampings fall on the press-bed and are then mechanically pushed out.
  - h. The use of mechanical rather than compressed air parts ejectors.

Noise Control Solutions for the Metal Products Industry - Page 3

8. Impact noise produced by stock-feed clamp-indexers can be controlled by replacing the clamp indexer with mechanical roll feeders, or the indexer may be enclosed and damping pads applied to the affected stock. Mufflers can be used on the pneumatic exhaust of the indexers.
9. Noise produced by parts-impacting-conveyors and chutes can be reduced by applying a viscoelastic damping layer.
10. Pin-type clutches of manual presses produce impact noise with peak levels of 124 dBA. This noise can be reduced by the use of a barrier or by replacement with an air clutch that has been quieted by applying a layer of damping material to the matching surfaces.
11. In presses with metal-to-metal impacts of stripper plates, the noise can be reduced by damping the plate or adding a nonmetallic contact surface. This may result in a noise reduction of up to 10 dB.
12. Vibration mounts are one of the least effective techniques of press noise control.
13. A properly equipped press includes features such as a brake or counterbalance to prevent the crank from "getting ahead of" the flywheel and causing an additional impact. Care in adjusting and maintaining these features will eliminate the unnecessary additional impact noise.
14. Counterbalances (mechanical, hydraulic, or pneumatic) can be installed on a press to reduce the noise produced as the elastic strains in the press body are suddenly released when the die penetrates the stock.

Noise Control Solutions for the Metal Products Industry - Page 4

15. When bumper blocks are used to limit positively the die shut height, a thin resilient shock-absorbing plastic insert can be put on the bumper block to reduce impact noise.
16. Flywheel guards can be constructed of damped metal or open mesh.
17. Partial enclosures can be constructed in the area of the die and plunger. If heavy materials and nearly airtight construction is used, noise reductions of 10 to 15 dB may be expected. Several examples are briefly discussed. Enclosures are said to be applicable only when a limited number of presses are involved, where visibility and frequent accessibility of the die are not required, and where sufficient space is available.

• *Pneumatic Tools*

1. The noise produced by pneumatic tools comes from the air exhaust, tool noise (impacts and rotation), and tool/workpiece interaction.
2. The easiest way to reduce pneumatic tool noise is to buy new quieted tools.
3. Piped-away exhaust systems reduce the air discharge noise at the operator's position, but impose certain cost and physical constraints.
4. The use of an expansion chamber or muffler around the tool exhaust port reduces the noise, but increase tool weight, size, and maintenance.
5. The installation of meshes, sintered metals, felts, or open-cell plastic foam at the exhaust ports reduces the exhaust velocity and noise. Requiring the exhaust air to travel a tortuous path through the tool to the exhaust port also reduces noise. Both techniques can cause clogging and increased back-pressure, thereby reducing tool power.



Noise Control Solutions for the Metal Products Industry - Page 5

6. Placing thick perforated plate over deteriorated exhaust ports of a vertical grinder can reduce noise levels by 10 to 12 dB.
7. Air leaks can generate noise levels over 90 dBA. These sources can be controlled by a continuing maintenance program.
8. If the workpiece is located on a metal bench, sound radiation from the bench can be reduced by covering its top with a durable rubber or plastic lining. As an alternative, wooden workbenches can be used.
9. Noise radiated by large castings being ground can be reduced by damping the casting; placement in a sandbox, for example, can provide some reduction.
10. Installation of a filter-lubricator can lower the sound level of a tool by 5 dB or more and also increase tool life.
11. Inspecting each tool for excessive noise each time it is brought to the maintenance department for repair is recommended.

• *Band Saws*

1. The noise produced by an operating band saw is generated by vibration of the saw blade, chatter between the workpiece and the saw table, and vibration of the workpiece.
2. One potential method to reduce the level of tooth passage frequency noise is to vary the blade speed; however, this is seldom practical.
3. Installation of rubber facings covering the pulley and/or guide wheels may reduce the noise level by 1 to 2 dB.
4. Placement of wear resistant rubber material on the surface of the saw table will reduce chatter noise.
5. Vibration of the workpiece can be reduced by application of a damping plate.

- *Shears*

1. The noise produced during shear operation is the result of the impact of the stock holddown mechanism, the impact of the blade on the stock, the "slap" and vibration of the stock on the table following shear, and the impact of the part drop.
2. Stock holddown impact noise can be controlled by covering the holddown mechanism with wear-resistant rubber material and by adjusting the control cylinder to reduce the impact force.
3. Blade impact noise on high speed continuous feed shears, which may exceed 100 dBA, can be reduced by placing the blade at a slight angle or by installing a machine cover or enclosure. Noise exposure is most easily controlled by isolating the operator.
4. The noise of the stock "slap" and vibration can be reduced by installing a wear-resistant vibration damping material on the table surface and by maintaining the holddowns in proper operating condition.
5. Spring-loaded rubber rollers can also be used to restrain the workpiece and reduce the stock "slap" noise.
6. The noise produced by the dropping of parts can be reduced by lining the drop panel with wear-resistant rubber, such as old conveyor belting, and by minimizing the drop height.

- *Air Noise*

1. Changes in the velocity of the gas stream have the greatest influence on jet noise. Cutting the *velocity* in half may lower the sound level as much as 24 dB. However, halving the *exhaust area* would reduce the sound level only 3 dB.

Noise Control Solutions for the Metal Products Industry - Page 7

2. When concentrated air flow is not necessary, air exhaust noise can be reduced by diffusing the airstream through a commercially available muffler.
3. Air leaks from pneumatic systems generate noise and can be minimized through a regular inspection and maintenance program.

APPENDIX C. DATA GATHERING AND DATA REDUCTION EQUIPMENT

The following is a list of equipment used in connection with this project.

Data Gathering Equipment

- Kudelski Stereo Tape Recorder Nagra SJIV
- BBN Noise Source
- Bruel & Kjaer Portable Level Recorder Type 2315
- Bruel & Kjaer 1/2 in. Microphones
- Bruel & Kjaer Accelerometer Type 4333
- Bruel & Kjaer Sound Level Meter Type 2215
- Bruel & Kjaer Calibrator Type 4220
- Bruel & Kjaer Calibrator Type 4230
- GenRad Preamplifiers Type 1560-P42
- GenRad Sound Level Meter Type 1982
- GenRad Calibrator Type 1567

Data Reduction Equipment

- Kudelski Stereo Tape Recorder Nagra SJIV
- Bruel & Kjaer Impulse Meter Type 2204
- Bruel & Kjaer Level Recorder Type 2305
- Bruel & Kjaer Statistical Distribution Analyzer Type 4420
- GenRad Sound Level Meter Type 1982
- GenRad Sound Level Meter Type 1551

Report No. 4782

Bolt Beranek and Newman Inc.

- GenRad Real Time Analyzer 1921
- Ithaco Power Supply P37
- Ithaco Amplifiers 453
- Tektronix Dual Beam Oscilloscopes 555 and RM 503
- Rockland Real Time Analyzer Model FFT
- Pandora Systems Inc. Time Level Model A-80-2
- Eico Power Amplifier HF-12