

EPA 500/9.77.401

NOISE EMISSION MEASUREMENTS FOR REGULATORY PURPOSES



NBS HANDBOOK 122

N-96-01

II-A-69

U.S. DEPARTMENT OF COMMERCE/National Bureau of Standards
in cooperation with

**U.S. ENVIRONMENTAL PROTECTION AGENCY/Office of Noise Abatement
and Control**

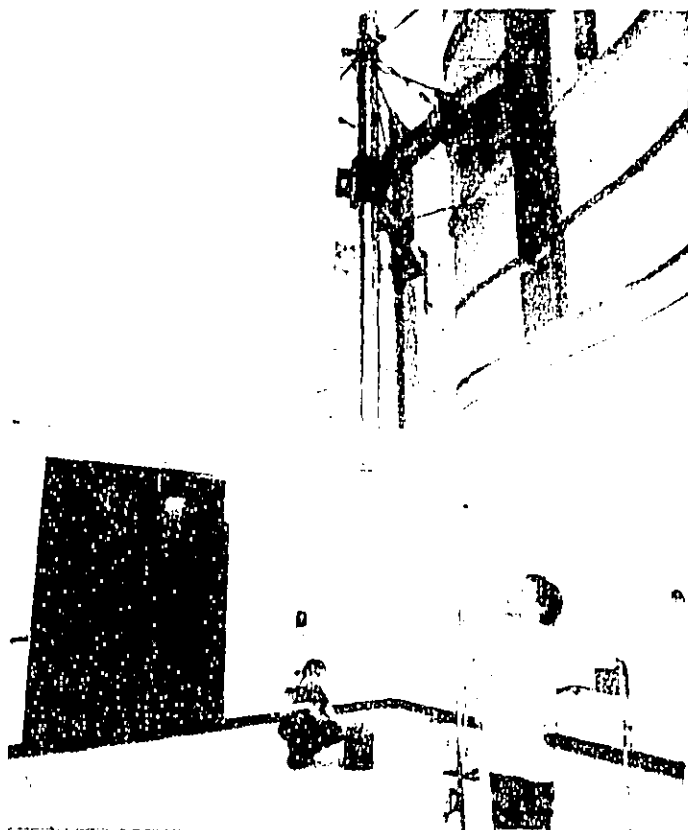

NATIONAL BUREAU OF STANDARDS

The National Bureau of Standards¹ was established by an act of Congress March 3, 1901. The Bureau's overall goal is to strengthen and advance the Nation's science and technology and facilitate their effective application for public benefit. To this end, the Bureau conducts research and provides: (1) a basis for the Nation's physical measurement system, (2) scientific and technological services for industry and government, (3) a technical basis for equity in trade, and (4) technical services to promote public safety. The Bureau consists of the Institute for Basic Standards, the Institute for Materials Research, the Institute for Applied Technology, the Institute for Computer Sciences and Technology, the Office for Information Programs, and the Office of Experimental Technology Incentives Program.

THE INSTITUTE FOR BASIC STANDARDS provides the central basis within the United States of a complete and consistent system of physical measurement; coordinates that system with measurement systems of other nations; and furnishes essential services leading to accurate and uniform physical measurements throughout the Nation's scientific community, industry, and commerce. The Institute consists of the Office of Measurement Services, and the following center and divisions:

Applied Mathematics — Electricity — Mechanics — Heat — Optical Physics — Center for Radiation Research — Laboratory Astrophysics² — Cryogenics² — Electromagnetics² — Time and Frequency².

THE INSTITUTE FOR MATERIALS RESEARCH conducts materials research leading to improved methods of measurement, standards, and data on the properties of well-characterized materials needed by industry, commerce, educational institutions, and Government; provides advisory and research services to other Government agencies; and develops, produces, and distributes standard reference materials. The Institute consists of the Office of Standard Reference Materials, the Office of Air and Water Measurement, and the following divisions:

Analytical Chemistry — Polymers — Metallurgy — Inorganic Materials — Reactor Radiation — Physical Chemistry.

THE INSTITUTE FOR APPLIED TECHNOLOGY provides technical services developing and promoting the use of available technology; cooperates with public and private organizations in developing technological standards, codes, and test methods; and provides technical advice services, and information to Government agencies and the public. The Institute consists of the following divisions and centers:

Standards Application and Analysis — Electronic Technology — Center for Consumer Product Technology: Product Systems Analysis; Product Engineering — Center for Building Technology: Structures, Materials, and Safety; Building Environment; Technical Evaluation and Application — Center for Fire Research: Fire Science; Fire Safety Engineering.

THE INSTITUTE FOR COMPUTER SCIENCES AND TECHNOLOGY conducts research and provides technical services designed to aid Government agencies in improving cost effectiveness in the conduct of their programs through the selection, acquisition, and effective utilization of automatic data processing equipment; and serves as the principal focus within the executive branch for the development of Federal standards for automatic data processing equipment, techniques, and computer languages. The Institute consists of the following divisions:

Computer Services — Systems and Software — Computer Systems Engineering — Information Technology.

THE OFFICE OF EXPERIMENTAL TECHNOLOGY INCENTIVES PROGRAM seeks to affect public policy and process to facilitate technological change in the private sector by examining and experimenting with Government policies and practices in order to identify and remove Government-related barriers and to correct inherent market imperfections that impede the innovation process.

THE OFFICE FOR INFORMATION PROGRAMS promotes optimum dissemination and accessibility of scientific information generated within NBS; promotes the development of the National Standard Reference Data System and a system of information analysis centers dealing with the broader aspects of the National Measurement System; provides appropriate services to ensure that the NBS staff has optimum accessibility to the scientific information of the world. The Office consists of the following organizational units:

Office of Standard Reference Data — Office of Information Activities — Office of Technical Publications — Library — Office of International Standards — Office of International Relations.

¹ Headquarters and Laboratories at Gaithersburg, Maryland, unless otherwise noted; mailing address Washington, D.C. 20334.
² Located at Boulder, Colorado 80502.

Noise Emission Measurements for Regulatory Purposes

D. R. Flynn
W. A. Leasure, Jr.
A. I. Rubin, and
M. A. Cadoff

National Bureau of Standards
Washington, D.C. 20234

In cooperation with the
U.S. Environmental Protection Agency
Office of Noise Abatement and Control



U.S. DEPARTMENT OF COMMERCE, Juanita M. Kreps, Secretary

Dr. Betsy Ancker-Johnson, Assistant Secretary for Science and Technology
NATIONAL BUREAU OF STANDARDS, Ernest Ambler, Acting Director

Issued March 1977

DEPT. AVIATION AND AIRCRAFT

Library of Congress Cataloging in Publication Data

United States. National Bureau of Standards.

Noise emission measurements for regulatory purposes.
(NBS Handbook; 122)

Supt. of Docs. no.: C13.11:122

I. Noise—Measurement. I. Flynn, D.R. II. United States. Environmental Protection Agency. Office of Noise Abatement and Control. III. Title. IV. Series: United States. National Bureau of Standards. Handbook; 122

QC100.U57 no. 468 [T12894] 620.2'3 76-608406

National Bureau of Standards Handbook 122

Nat. Bur. Stand. (U.S.), Handb. 122, 193 pages (Mar. 1977)

CODEN: NBSHA

**U.S. GOVERNMENT PRINTING OFFICE
WASHINGTON: 1977**

For sale by the Superintendent of Documents, U.S. Government Printing Office
Washington, D.C. 20540 - Price \$2.00

Abstract

A review is given of the measurement needs attendant to regulation of the noise generated and emitted by commercial products. The emphasis is primarily on measurement procedures for use in conjunction with point-of-sale regulations as opposed to regulations on the noise which a source actually emits when in operation. The report is divided into three major parts. Part I is a discussion of overall measurement requirements and the type of data and information which are needed in order to promulgate regulations based on appropriate measurement techniques. Part II is designed as a checklist for the evaluation of the suitability of a noise measurement standard for a particular class of products or, in the absence of a suitable standard, as a framework for development of one. The intent is to identify and discuss in some detail those factors which can impact on the accuracy, precision, and applicability of a noise measurement process. Part III consists of a series of flow charts depicting the development of appropriate procedures for the measurement of product noise emission.

Key Words: Acoustics; environmental pollution; machinery and equipment; noise; noise abatement and control; noise emission; regulation; sound.

Table of Contents

	Page
Acknowledgements	xiii
PART I: Overall Requirements	1
1. Introduction	1
2. Measurement Methodology Development -- Overview	4
2.1. Product Classification	4
2.2. Normal Use Conditions	4
2.3. Identification of Major "Effects" Parameters	4
2.4. Physical Measurements Correlated with Major Effects.	4
3. Relationship of Measurement to Regulations.	5
3.1. Role of Measurement.	5
3.2. Measurement Requirements for Regulation.	5
3.3. Measurement Uncertainty Considerations in Establishing Regulatory Noise Limits	6
4. Informational Requirements for Setting Noise Regulations: Product Classification Scheme	9
5. Informational Requirements for Setting Noise Regulations: Operating Procedures and Environment.	12
5.1. Typical Usage Data	12
5.2. Effect on Noise Levels	12
a. Operation	12
b. Environment.	14
c. Installation	14
6. Informational Requirements for Setting Noise Regulations: Effects of Noise on People.	16
6.1. Parties Affected	16
a. Operator	16
b. Passenger	16
c. Neighbor	16
d. Bystander	16
6.2. Nature of Effects.	17
a. Hearing Loss	17
b. Task Interference	17
c. Annoyance.	17
7. Quantitative Description of Noise	18
7.1. Identification of Major Parameters	18
a. Relationship to Effects	18
b. Environment/Use Conditions	18

	Page
7.2. Measurement Parameters	19
a. Sound Level.	19
b. Spectral Quality	19
c. Temporal Variation	19
8. Consensus Procedures for Measurement Standards and Rating Schemes	21
8.1. Input from All Affected Parties	21
8.2. International Trade	21
9. Environmental Protection Agency Promulgation of Regulations	22
9.1. Special Requirements	22
a. Product Noise Emission Standards	22
b. Labeling	22
c. Low-Noise-Emission Product Certification Procedures	23
9.2. Technical, Economic, and Administrative Feasibility as It Relates to Measurement	23
9.3. Compatibility with Other Regulations and Needs	23
10. Recommended Operational Procedure for Generating Measurement Methodologies for Specific Product Classes.	25
References for Part I	28
 PART II: Contents of Measurement Standards	 29
11. Purpose and Applicability	30
11.1. Introduction	30
11.2. Scope and Purpose	30
11.3. Definitions and References	31
11.4. Acoustical Quantities to be Measured	31
11.5. Applicability.	35
a. Types of Noise	35
b. Nature and Size of Source.	38
c. Measurement Uncertainty.	38
12. Acoustic Environment.	41
12.1. General Requirements	41
12.2. Criteria for Adequacy of the Test Environment.	43
a. Anechoic Environment	43
b. Semi-Anechoic Environment.	48
c. Reverberant Environment.	53
d. <u>In Situ</u>	68
12.3. Criteria for Background Noise.	68

	Page
12.4. Criteria for Temperature, Barometric Pressure, Humidity, and Wind.	70
a. Temperature	70
b. Barometric Pressure	71
c. Humidity.	75
d. Wind.	77
12.5. Criteria for Size of the Test Equipment	77
12.6. Criteria for Reflecting Surfaces.	77
13. Instrumentation for Noise Measurements	78
13.1. General Requirements.	78
13.2. Microphone and Cable.	79
13.3. Frequency Response of the Instrumentation System.	79
13.4. Weighting Network and/or Frequency Analyzer	80
13.5. Signal Detection and Averaging.	81
13.6. Read-Out Device	83
13.7. Transient Response of Instrumentation System.	85
13.8. Calibration and Maintenance of Instrumentation System	85
13.9. Precautions to be Taken When Selecting Instrumentation.	86
14. Installation and Operation of Source	89
14.1. Source Location	89
14.2. Source Mounting and Installation.	91
14.3. Auxiliary Equipment	92
14.4. Operation of Source During Test	94
14.5. Loading of Equipment During Test.	96
15. Measurement Procedures	98
15.1. General	98
15.2. Microphone Positions.	112
a. Anechoic Space.	112
b. Hemi-Anechoic Space	113
c. Reverberant Space	119
15.3. Source Positions	130
15.4. Period of Observation	131
15.5. Use of Diffusers.	131
15.6. Background Noise Measurements	132
15.7. Characterization of Test Environment.	133
a. Anechoic Chamber.	133
b. Hemi-Anechoic Environment	133
c. Reverberant Environment	134
15.8. Calibration	135
16. Calculation Procedures	136
16.1. Correction for Background Noise	136
16.2. Correction for Test Environment	137
16.3. Determination of Mean-Square Pressure	137
16.4. Calculation of Sound Power.	137
16.5. Calculation of Noise Rating	137
16.6. Calculation of Measurement Uncertainty.	137

	Page
17. Information to be Recorded	139
17.1. Sound Source Under Test	139
17.2. Sound Source Installation Details	139
17.3. Sound Source Operating Procedures	140
17.4. Acoustic Environment	140
17.5. Instrumentation	140
17.6. Special Measurement Procedures	141
17.7. Calibration History	141
17.8. Acoustical Data and Related Information	141
17.9. Special Calculation Procedures	141
17.10. Measurement Uncertainty	141
18. Information to Be Reported	142
18.1. Identification of Source	142
18.2. Source Installation and Operating Procedure	142
18.3. Deviations from Standard Measurement Procedures	143
18.4. Acoustical Data and Related Information	143
18.5. Measurement Uncertainty	143
References for Part II.	144
PART III: Selection of Measurement Methodology Appropriate to a Specific Product	153
Appendix A. List of Participants at Government/Industry Meetings on Noise Measurement Methodology for the Environmental Protection Agency's Noise Emission Regulations	160
Appendix B. Pertinent Sections of the Noise Control Act of 1972.	163
Appendix C. Uncertainty of Measurement	166
Appendix D. Possible GATT Code of Conduct for Preventing Technical Barriers for Trade	169
References for Appendix D	172
Appendix E. Methods of Labeling	173
References for Appendix E	180

FIRST AVIAN ABLE COPY

List of Figures

	Page
Figure 1. Development of measurement methodology needed for implementation of Public Law 92-574: Sections 6, 8, 15, 17 and 18.	2
Figure 2. Recommended operational procedure for generating measurement methodologies.	26
Figure 3. Schematic representation of a sound source in an anechoic chamber.	45
Figure 4. Maximum range of uncertainty in the sound pressure level in an anechoic chamber as a function of Π_R and Π_a , defined in the text (for a single wall, normal incidence).	47
Figure 5. Hypothetical variation of sound pressure level versus distance as one wall of an anechoic chamber is approached.	49
Figure 6. Schematic representation of a sound source in a free field above a reflecting plane.	51
Figure 7. Limits for the effect of the image source on the observed sound pressure level as a function of the absorption coefficient of the reflecting plane with r/r' as a parameter.	52
Figure 8. Difference between the total sound level and that due to the reverberant field alone, shown versus the effective distance from the source.	57
Figure 9. The effect of neglecting the $10 \log (1-a_0)$ term in eq. (16).	59
Figure 10. Approximate number of normal modes in a 1/3-octave frequency band for cubical rooms of the volume shown.	61
Figure 11. Frequency response of a reverberation room having equal-strength modes at 95, 100, and 105 Hz for reverberation times of 1 and 20 s, respectively.	63
Figure 12. Range of the variation (peak-to-valley in Figure 11) in the frequency response of a reverberation room for frequencies near 100 Hz as a function of reverberation time for different modal spacings.	64
Figure 13. Drawing illustrating the spacing, δf , between normal modes, the width, Δf , of a normal mode, and the relationships among Δf , f_0/Q , τ , and T	66

Figure 14.	Pressure dependence of the acoustic resistance of air.	73
Figure 15.	Atmospheric absorption loss in air as a function of temperature for relative humidities of 10 and 70 percent at frequencies of 1000 and 4000 Hz.	76
Figure 16.	Schematic representation of instrumentation for sound level measurements.	78
Figure 17.	Confidence intervals as functions of BT for measurements on random noise.	84
Figure 18.	Schematic representation of a rigid circular piston of radius, a , contained in an infinite baffle.	103
Figure 19.	Variation of the axial intensity level due to a baffled rigid piston of radius, a , vibrating at an angular frequency, ω	105
Figure 20.	Far-field radiation patterns showing the directionality for a baffled rigid piston.	106
Figure 21.	Axial intensity level due to an incoherent circular source.	107
Figure 22.	Schematic representation of sound radiation from an infinite plate in which there is a plane bending wave propagating at speed, c_B	107
Figure 23.	Far-field intensity level above the critical frequency for an infinite plate in flexure.	110
Figure 24.	Intensity level parallel to an infinite plate in flexure at frequencies below the critical frequencies.	111
Figure 25.	A suggested set of continuous microphone traverses for determination of sound power in a free field above a reflecting plane.	114
Figure 26.	Effect of bandwidth on directivity of sound field of a point source at a distance, h , from a reflecting plane.	116
Figure 27.	Error introduced by limited number of measuring points when determining sound power output of a random point source near a reflecting plane.	117
Figure 28.	System for microphone traverses along meridional paths.	118
Figure 29.	Microphone array for a parallelepiped measurement surface.	120

BEST AVAILABLE COPY

Figure 30.	Microphone array for a "composed" measurement surface.	121
Figure 31.	Upper limit on the number of microphone positions in rooms of the volumes shown if each position is at least a half-wavelength from all other positions.	122
Figure 32.	Normalized variance of the mean-squared sound pressure in a room having a reverberation time, T, and excited by random noise of bandwidth, B.	124
Figure 33.	Minimum number of microphone positions needed for 1/3-octave bands of noise in order to have 95 percent confidence that the spatial average of the mean-square sound pressure is known within ± 1 dB.	125
Figure 34.	Normalized variance of the mean-squared sound pressure in a room, having a reverberation time, T, excited by M equal-strength pure tones uniformly separated in frequency by δf	128
Figure 35.	Development of appropriate test procedure.	154
Figure 36.	Development of appropriate classification scheme.	155
Figure 37.	Identification of operational modes indicative of product usage.	156
Figure 38.	Collection of noise effects data.	157
Figure 39.	Selection of appropriate measurement locations.	158
Figure 40.	Selection of appropriate test environment criteria.	159
Figure 41.	Sample of the energy labels now found on many room air conditioners.	178

DEPT AVIAR 101 E AVIAR

Acknowledgements

The National Bureau of Standards gratefully acknowledges the assistance of many people and organizations who contributed to the preparation of this report. Their contributions have made it possible to produce this document. The following groups and individuals deserve special recognition.

Between July 20, 1972 and December 20, 1972, a series of meetings was conducted by NBS with representatives of governmental and industrial organizations to obtain inputs prior to the development of this report. During these meetings we discussed special problems and reviewed the existing data base, including present noise levels, typical operational modes and use statistics. Finally, we tried to identify the critically important information necessary to evaluate the implications of noise measurement methodologies. These include problems associated with the technical capability of an industry to use a particular measurement methodology and the possible economic impact associated with alternative measurement requirements. We thank the following groups for their important contributions, which in many instances included a written critical review of the initial draft of this report.

- o Acoustical and Insulating Materials Association
- o Air Conditioning and Refrigeration Institute
- o American Road Builders Association
- o American Short Line Railroad Association
- o American Trucking Associations
- o Association of American Railroads
- o Association of Home Appliance Manufacturers
- o Construction Industry Manufacturers Association
- o U. S. Department of Transportation (Federal Railroad Administration and the Office of Noise Abatement)
- o Engine Manufacturers Association
- o General Services Administration (Public Building Services)
- o International Snowmobile Industry Association
- o Motor Vehicle Manufacturers Association
- o National Electrical Manufacturers Association
- o SAE Motorized Snow Vehicle Subcommittee
- o U. S. Postal Service

We would further like to recognize the significant contributions of the following five acousticians for their critical review of the initial draft of the report and their many useful and timely suggestions.

Dr. Erich K. Bender
Bolt Beranek and Newman, Inc.

Mr. George M. Diehl
Ingersoll-Rand Company

Dr. Tony F. W. Embleton
National Research Council (Canada)

Mr. George W. Kamperman
Kamperman Associates, Inc.

Dr. William W. Lang
IBM Corporation

Joseph M. Cameron, Joan R. Rosenblatt, and Hsien H. Ku provided very valuable input to the discussions of measurement uncertainty.

Particularly helpful guidance in the early stages of preparation of this report was provided by Mr. John C. Schettino and Mrs. D. Elizabeth Cuadra of the U. S. Environmental Protection Agency Office of Noise Abatement and Control.

In addition we would like to acknowledge the editorial contributions of Mr. Edward Case.

PART I OVERALL REQUIREMENTS

1. Introduction

This report is the result of a project initiated, in May 1972, by the National Bureau of Standards at the request of the Office of Noise Abatement and Control, U. S. Environmental Protection Agency, in anticipation of the eventual passage of legislation authorizing the Environmental Protection Agency to promulgate noise emission standards and labeling requirements.

The intent of the project was to develop a working document to be utilized by the Environmental Protection Agency, or its designated agents, in the development of measurement methodologies for noise emission or labeling standards. The questions that need to be addressed during the development of such methodologies are presented here with their appropriate technical backup. The specific directions of effort and emphasis were developed in response to:

- Discussions with Environmental Protection Agency personnel
- Meetings with trade associations
- Meetings with standards organizations
- Literature review
- Consultations with acoustical experts
- Legal requirements of the Noise Control Act of 1972.

A listing of the meetings with other organizations, including the individual participants and the companies or agencies they represented at the meetings, is given in Appendix A.

The general strategy of this report is depicted in Figure 1.

The Noise Control Act of 1972, Public Law 92-574, which was signed into law on October 27, 1972, requires or authorizes the Administrator of the Environmental Protection Agency to control the emission from noise sources that constitute a potential threat to the public health and welfare so as to provide people with an environment which is free from noise that jeopardizes their health and welfare. This policy will require actions for which appropriate supporting measurement methodology must be developed. The actions are summarized in Appendix B for the benefit of those readers who are not familiar with the Act. The criteria documents and major noise source identification reports developed in response to Sec. 5 of the Noise Control Act of 1972 are the logical starting points for the development and assessment of the necessary measurement methodology.

Figure 1 shows that one needs to collect data regarding product classification, product usage, product noise production, and the resultant effects of the noise on people. These data are to be used in determining the

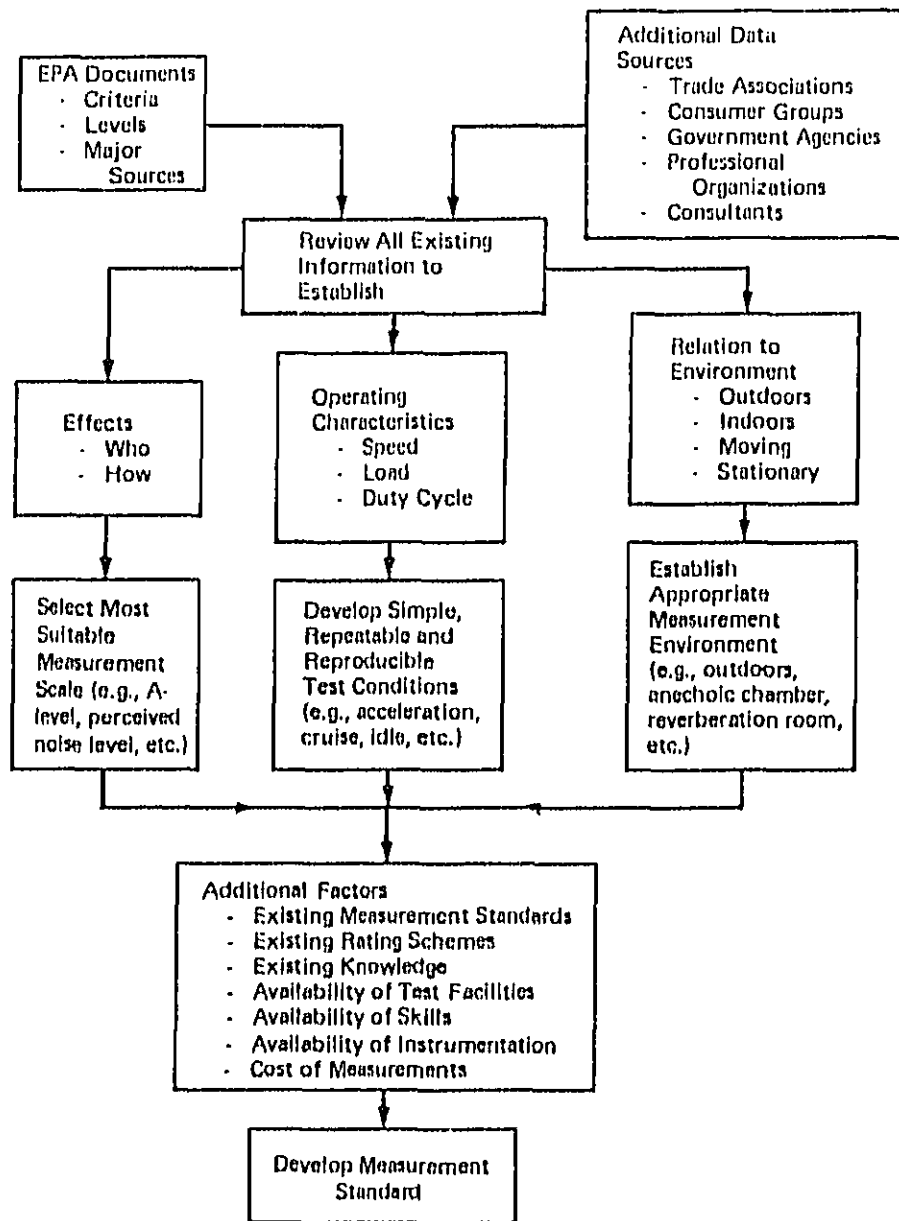

Figure 1. Development of measurement methodology needed for implementation of Public Law 92-574: Sections 6, 8, 15, 17 and 18.

acoustical quantity to be rated, the scheme to be used for a noise rating methodology which adequately correlates with human response, and, finally, the measurement standard to be used in conjunction with the emission standard or other regulation. Note that the word "standard" is customarily used with two very different meanings. An emission standard is a legal permissible limit, for example, on noise emission. A measurement standard is a prescribed procedure for conducting a measurement in such a way as to obtain reliable, reproducible results with a specified level of accuracy.

Conceptually, there are three separate items which go into the noise emission regulation, whether it be a noise emission standard, a labeling requirement, or the procedure for certifying low-noise-emission products. (1) There should be a measurement standard which prescribes the test environment, operating procedures, and acoustical measurement methodology. (2) There should be a scheme, or algorithm, by which the acoustical data can be used to obtain a noise rating which relates to human response. (3) There should be a level, or set of levels, which separate the noise rating into categories of performance or acceptability. For example, a noise emission standard could set a single upper limit on the noise rating -- products exceeding that rating could not be sold. Alternatively, it could set an upper limit which varied with some operating parameter such as speed; the noise rating could not exceed that curve at any value of the operating parameter. A labeling requirement might establish several classes (e.g., A, B, C, and D) into one of which the noise rating would fall.

Once a regulation has been promulgated, a reasonable and equitable enforcement program is a necessity; for without enforcement, the regulation is meaningless. The importance of highly repeatable, accurate measurements should be quite clear in the enforcement area. To stand up in court, a measurement must be proved to be reliable, of accuracy sufficient for the purpose, and appropriately related to the adverse impact of the noise on people. In addition, a measurement assurance program is highly desirable to ensure that the determination of a product's noise rating will be independent of the organization performing the measurements -- EPA, manufacturers, independent test laboratories. Unless minimum requirements are placed on instrumentation, calibration, test facilities and personnel conducting tests, no assurance will exist that a product actually conforms to the regulation.

Section 2 of this report provides an overview of the measurement methodology development process while Section 3 is concerned with the role of measurement in relation to regulations. ensuing sections develop in detail the concepts depicted in Figure 1. It should be emphasized that the flow of action is not as simple and unidirectional as indicated in Figure 1. Rarely, if ever, would it be possible to progress directly from the input data to the rating scheme and measurement standard and then to the regulation without considerable retracing. In the interest of simplicity, the many feedback loops have been omitted.

2. Measurement Methodology Development -- Overview

A sequence of activities must be completed in assigning a meaningful noise rating to a product. An overview of the steps involved in this process is presented below -- a more detailed treatment appears in the succeeding sections of Part I.

2.1. Product Classification

The vast number of available products which might be regulated precludes handling each on an individual basis -- this would constitute an endless task. However, categories of products may be subdivided into product classes based on critical parameters associated with noise. The scope and effectiveness of the regulatory task will largely be determined by the degree of success achieved in devising useful product classifications.

2.2. Normal Use Conditions

Discussions with organizations concerning product noise have invariably dealt with the requirement to consider a device under realistic use conditions. By ignoring the environmental and operating characteristics it might be easier to develop standardized measurement techniques but it then becomes almost impossible to relate the noise output to impact on people. If the noise impact is not determined, the reason for making the measurement and the validity of any rating are questionable.

2.3. Identification of Major "Effects" Parameters

The characteristics of noise associated with the major physiological, psychological and sociological effects and the resultant impact form the basis of the criterion measure to be ultimately employed by the Environmental Protection Agency (along with considerations of technical and economic feasibility). Among those features usually defined are "loudness" (or noisiness) and annoyance. The disruption of tasks such as speech communication is another major consequence of noise often noted.

2.4. Physical Measurements Correlated with Major Effects

When the major parameters associated with effects and population impact have been identified and their physical correlates determined, a meaningful test methodology can be developed. Measures of sound level, spectral characteristics and temporal variation form the basis for these quantitative descriptions.

3. Relationship of Measurement to Regulations

3.1. Role of Measurement

Good measurements are essential to research and development activities. Often solutions to problems cannot be implemented because of the lack of relevant data. Under these circumstances, an appropriate data base must be developed. This often calls for improved measures to develop control techniques and/or to determine their effectiveness. In addition, generally accepted and standardized test methods assume an important role so that data acquired at different times or places can be compared and related meaningfully.

Noise measurements need to be conducted under both laboratory and field conditions to meet the dual objectives of scientific accuracy and relevance to real-use conditions. The primary goal is to make valid and reliable measurements such that the actions taken on the basis of a measurement are only negligibly affected by the errors in the measurement.

The primary questions are:

- o What needs to be measured?
- o What is now measured?
- o How is it now measured?
- o What are the current requirements concerning measurement uncertainty? (Appendix C contains a discussion of uncertainty of measurement).
- o What are limitations of present instruments and methodology?

If the answers to these questions result in poor or inadequate data, another question must then be answered:

- o What research and development need to be accomplished to make the required measurements?

3.2. Measurement Requirements for Regulation

The assessment of noise problems and of alternative strategies for noise abatement and control must ultimately rest on accurate, reliable, and relevant measurement capability required to:

- o ascertain the effects of a given noise exposure (what exposure will produce how much hearing damage?)
- o establish trends (is the average noise exposure of the populace increasing and are more people being exposed?)

- o associate sources with environmental noise levels (how much of urban noise comes from trucks? from planes? from air conditioners?)
- o promote equity in trade (are manufacturers being treated equally in voluntary or mandatory noise emission standards programs?)
- o provide adequate information to the consumer (which of several products is really the quietest and are the noise level differences among products significant?)
- o permit selection of cost-effective solutions (what degree of noise reduction should be attained and at what cost?)
- o monitor the effectiveness of control programs (is the noise level actually responding to new control procedures?)
- o provide the factual (measurement) basis for legal action should that prove necessary. (Is a particular noise source in violation? To stand up in court, a measurement must be proved to have an uncertainty which is sufficiently small for the purpose.)

3.3. Measurement Uncertainty Considerations in Establishing Regulatory Noise Limits

How can effective noise regulation be carried out in such a way as to minimize interference with such important values as individual freedom of choice, dynamic operation of the marketplace, and progress in the development and use of new science and technology?

There are three needs attendant to the problem of the abatement of excess noise: first, an agency to execute the overall policy set by the legislative process; second, a mechanism to determine allowable levels of noise; and third, a means of enforcing the determined requirements. Measurement is a key element in defining "allowable levels of noise" and "enforcing the determined requirements."

More generally, measurements are essential to effective communications in transmitting the complex information required for noise abatement and control. The results of measurements are data which are the bases for judgments as to acceptability of products, violations of law, etc.

The question arises as to whether close measurement tolerances -- attainable by careful control of environment, operating procedures, and

measurement procedure -- are justified in view of the uncertainties in the application of the resultant noise rating to predict in-service noise levels and the resultant effects. First, the total error in prediction involves the sum of the errors in measurement and rating, in predicting in-service levels and in predicting the resultant effects. Reducing the rating error thus reduces the total error; however, it would be economically wasteful to insist upon high levels of accuracy and precision for rating measurements if the errors in predicting in-service levels and resultant effects are relatively gross and difficult to control. Second, application errors and, to some extent, effect-prediction errors tend to be averaged out from one application to another; systematic errors are repetitive. Third, when noise ratings are used to compare the performance of a product to the requirements of a regulation or to the performance of a competitive product, if the ratings are in error, difficulties in enforcement, inequities in trade, and excessive costs may be incurred. Careful evaluation of measurement uncertainties is required for assurance that they are neither too small nor too large in relation to the purpose for which the measurements are made.

The setting of the enforcement level relative to the legal limit, for test results to be based on some sample of the product, depends to a large extent on the measurement uncertainty, the variability of the product, and the desired levels of risks in accepting non-conforming units and rejecting conforming units (e.g., see [1]). In general, for regulations to be effective and reasonable, measurement uncertainties should be as small as practicable. If, for example, the legal limit is 80 dB and the measurement uncertainty is ± 5 dB, procedures will be needed for interpreting a noise level close to the legal limit such as 83 dB or 77 dB. The existence of a violation can be sustained more effectively when the noise level is above the legal limit by an amount greater than the measurement uncertainty, and the public is better assured of conforming products if the noise level is below the legal limit by a similarly convincing amount. The difficulty is compounded by the need for uniformity of enforcement, i.e., consistent measurements by different officials. The largest uncertainty likely for measurements by the least competent official, using the most inaccurate or imprecise equipment allowable, under the least favorable test conditions, must be considered in the process of setting the enforcement limit. If this measurement uncertainty is large, the enforcement agency's problems are increased. If the enforcement level is set above the legal limit, it appears that the agency is not enforcing the desired noise abatement. If the enforcement level is set below the legal limit, manufacturers incur increased compliance costs.

Measurement uncertainties should also be held as small as practical for trade equity. For example, if products are graded A, B, C, D in terms of noise emission, the attainable measurement errors should be considerably smaller than the steps between the middle of adjacent grades. Otherwise, products could be incorrectly labeled, resulting in unfair competitive situations. Similarly, of two competing products with identical noise emission, one could be banned from sale while the other would be allowed to be sold -- both being tested against the same emission standard.

Cost of compliance with emission standards, or of meeting a certain labeling grade, can be increased significantly due to measurement uncertainties. As products are quieted more and more, the incremental cost of quieting typically increases. Thus, for example, if due to measurement uncertainties, it were necessary to quiet a product by 10 decibels to be certain that it is at least 5 decibels quieter, the cost-to-quiet may be several times greater than if the measurement uncertainty were, say, 1 decibel.

DC:DP 41148 201 2 2000

4. Informational Requirements for Setting Noise Regulations

Product Classification Scheme

Consumer products are classified into categories which relate to differences in the design, shape, style or quality of similar products. Classification schemes are based on power, capacity, weight, etc.

Questions concerning product classification systems to be used for noise ratings include:

- Does a classification system exist within a given industry regardless of whether or not it is appropriate for noise measurement?
- Does the existing classification system lend itself to acceptance as a categorization with noise as the item of concern rather than weight, power, etc?
- Is the level of classification detail sufficient for the measurement methodology to be universally applied?

In general, satisfactory classifications do exist for most products. As an example, pumps can be classified:

- by capacity -- 10 to a million gallons per minute.
- by application -- industrial, commercial, agricultural, municipal, domestic.
- by the materials that they are capable of handling -- water, sulphur, solids, slurry, liquid metal.
- by pressure range -- high, medium, low, vacuum.
- by design -- turbine, axial flow, centrifugal, rotary, reciprocating.
- by salient features -- submersible, self-priming, proportioning, non-clogging, measuring.
- by the material used -- stainless steel, plastic, bronze.

All of the above classification schemes are valid for specific applications; however, none of them has noise as its primary basis.

The fact that pumps can be subdivided into a myriad of classifications should be considered with caution since some products are not so readily classified. For instance, the construction industry has no classification scheme for its products. As a first step in developing such a scheme, the

Construction Industry Manufacturers Association asked its members to define their concept of that piece of construction equipment known as a roller/compactor. The answers identified approximately fifty different devices ranging in weight from hundreds of pounds to several hundred-thousands of pounds. The list represented self-propelled, towed, and even hand-controlled machines.

Motor vehicles offer another example. Since all motor vehicles do not have the same noise generation characteristics, the category "motor vehicles" must be further subdivided. According to functional characteristics, the next level of detail would break into trucks, cars, buses and over-the-road recreational vehicles. Utilizing gross vehicle weight as a further subdivision at this level of classification, the Society of Automotive Engineers, Inc. established its noise standards for motor vehicles (highway). One standard exists for passenger cars and light trucks (vehicles of 6000 pounds or less) and another applies to heavy trucks and buses. No specific standards now exist for over-the-road recreational vehicles. Thus a passenger car could weigh more than 6000 pounds and theoretically would be considered a truck from a noise regulation standpoint. Licensing is not the final answer since the distinctions between trucks and passenger cars for licensing purposes are sometimes quite subtle. For instance, a four-wheel drive vehicle is licensed in the state of Maryland as a truck unless it has a rear seat for carrying passengers; then it is licensed as a car. Such an arbitrary system could penalize a given vehicle due to an optional feature which has no bearing upon the vehicle noise generation.

Even after the classification scheme is determined, all problems are not solved. A tractor-trailer combination is considered as a truck by most people. However, to the industry it is comprised of two independent parts designed and fabricated by different manufacturers -- the tractor and the trailer. The eventual noise level produced by the combination depends on a third party -- the fleet or individual owner -- who matches tractor to trailer and determines which tires are mounted on each (tires usually control noise emission at moderate-to-high speeds for well-maintained vehicles equipped with adequate muffling systems). Since tractor-trailer "trucks" are not sold as such in commerce, the Federal regulation of these might have to be via product noise emission standards (Sec. 6 of Public Law 92-574) for the products (tractor, tires) which are sold separately plus motor carrier noise emission standards (Sec. 18 of Public Law 92-574) for the overall vehicle.

Devices could also be classified by the noise they produce versus such considerations as the service they perform (buses contrasted to automobiles), their location (urban versus remote or rural), and their effects (how many people are affected and in what way?). For example, farm machinery could be placed in a separate classification since the location is usually rural and the only people impacted are the farmers themselves. In this case the most economical noise control solution might be an enclosed cab which would protect the operator of the machine.

It should be evident that product classification is not the simple matter that it may have seemed at first glance. Much thought must be given to the relevance of existing systems and the development of new schemes where classification does not now exist. With the high costs associated with instrumentation, facilities, and the trained manpower to make the measurements, one would hope that appropriate classification schemes can be developed so that a separate and distinct measurement methodology would not be necessary for each product.

5. Informational Requirements for Setting Noise Regulations

Operating Procedures and Environment

"Scatter" typically is observed in test data. With the advent of government noise regulations, it becomes increasingly imperative to determine the sources of variability in test results. Existing test procedures should be revised and new procedures developed to be less sensitive to device operation and test site conditions.

Test procedures should represent typical operating modes -- that is, relevant either to community or operator noise exposure to the device under test.

5.1. Typical Usage Data

In general, products have a range of possible operational modes with the noise emission characteristics dependent on how they operate. The key to deciding upon the mode or modes of operation of a device that should be specified for noise test purposes hinges on the knowledge of how the device is "normally" operated. In order to determine "normal operation," a usage survey should be conducted. The results of one such survey[2] in the outboard motor field are shown in Table 1.

Although the data are limited, it is interesting to note the very low percentage of time that pleasure boats run at wide open throttle (maximum noise position). This example is not atypical. In the case of railroad locomotives, for instance, over 30 percent of the time the vehicle is at idle. These examples substantiate the fact that usually it will not be sufficient to make measurements only during that operation which produces maximum noise since most devices are not so operated for long periods of time. In addition, people can be annoyed, or have their conversations interfered with, at noise levels much lower than the maximum.

5.2. Effect on Noise Levels

There are a great many noise sources and noise environments to which people are exposed. The noise emission from a given machine in a specific location is dependent not only on the sound radiating characteristics of the machine itself but also upon the type of mounting, the manner in which the machine is operated, and its environment. In setting noise limits for such devices through regulations, the measurement system should include specification of such items as operating conditions and environment -- both installation and weather.

a. Operation

Attention must be given to the operational procedure utilized for a given test since the noise produced depends heavily on the way a

Table 1. Outboard Motor Field Usage Study

Outboard	Boat	Hours	PERCENTAGE TIME IN EACH SPEED RANGE										
			500 1000 RPM	1000 1500	1500 2000	2000 2500	2500 3000	3000 3500	3500 4000	4000 4500	4500 5000	5000 5500	5500 6000
125 HP	17 Ft. Runabout	16.72	34	12	3	5	6	14	12	10	3	1	*
100 HP	17 Ft. Runabout	11.56	32	20	7	3	1	7	13	11	4	2	*
100 HP	18 Ft. Runabout	48.94	24	14	4	2	1	4	11	33	5	2	*
55 HP (TWIN)	23 Ft. Cruiser	24.30	4	19	15	5	2	2	8	37	8	0	*
50 HP	16 Ft. Runabout	14.24	13	19	5	10	5	10	7	10	5	11	5
50 HP (TWIN)	20 Ft. Cruiser	13.56	5	12	11	5	5	12	24	22	2	1	1
40 HP (TWIN)	16 Ft. Runabout	14.44	3	13	12	7	3	13	13	19	12	5	*
9 1/2 HP	16 Ft. Fishing Boat	21.56	6	13	10	6	6	9	8	19	18	5	*
9 1/2 HP	14 Ft. Fishing Boat	14.28	12	11	7	9	3	9	5	25	15	4	*
9 1/2 HP	14 Ft. Fishing Boat	10.24	4	11	12	19	11	25	15	3	0	*	*
9 1/2 HP	14 Ft. Fishing Boat	10.16	9	11	9	4	4	9	22	19	12	*	*

*Outboard motor was not set to run in this speed range at wide open throttle.

piece of equipment is operated. Two devices might generate comparable noise levels when operated in a certain mode yet might produce quite different noise levels when operated in another mode.

b. Environment

The term environment, as used here, means the aggregate of all external conditions and influences affecting the noise levels of a given device, wherever the measurements are made.

Airborne sound from an outdoor source travels from the source to the receiver through an atmosphere that is constantly in motion. Turbulence, temperature and wind gradients, and reflections from the earth's surface all affect the measured data. Essentially there are two distinct effects corresponding to: (1) external factors (usually atmospheric) which affect the sound pressure level at a particular point and (2) external factors which affect the accuracy of its measurement.

One also must be concerned with the environment indoors. Room volume, the sound absorption of the walls, floor and ceiling, and the location of both the noise source and receiver must be carefully evaluated. For instance, a sound level very near a noisy machine may not be affected by sound-absorbing materials on the walls. However, such materials will affect the sound level measured farther from the machine.

There are just a few of the factors that should be considered. In many cases, there are factors over which the investigator may have little or no control.

c. Installation

Another important factor affecting the noise level associated with a device is the manner in which it is installed.

For example, the resultant noise level for a food-waste disposer is dependent on (1) the effectiveness of the vibration isolation of the disposer from the sink, (2) the damping characteristics of the sink itself, (3) whether the connections between the disposer and the drain pipe are flexible or rigid, (4) the effectiveness of the closure of the mouth of the disposer and (5) whether the grinding chamber and motor are enclosed.

Installation is likewise crucial when one considers any type of component noise, for example, motors or engines. Returning to the boating industry, every engine and drive unit, whether it is outboard, stern drive, or inboard, will create a different noise signature, depending on the boat to which it is coupled. Each boat will respond in a different manner, and the overall boat noise can change with different loads and operating conditions.

When measurements are made to determine compliance with applicable acoustic objectives, specifications or standards, the device should be installed in a manner similar to that in a typical customer's facility, if that is practical.

6. Informational Requirements for Setting Noise Regulations

Effects of Noise on People

Since noise regulations are designed to limit the exposure of noise on people, it is necessary to determine who is affected, with what impact, by a particular product and how these effects are manifested. These factors are largely governed by the product and the way that it is normally used.

6.1. Parties Affected

The relationship between the operating environment and the determination as to who is affected by a given noise becomes evident when products are classified in terms of their mobility (or in terms of people's mobility relative to the sources). For example, transportation vehicles have a far different impact on a community than a home air-conditioning unit. An exploration of these different types of noise sources will serve to illustrate their general effects.

a. Operator

The operating procedures associated with a product will indicate how an operator interacts with a product -- what he does and where he is positioned. These data provide the context for determining the effects of noise on a given operator. The operator need not be the person exposed to the most severe noise effects. In fact, in some instances, a product is designed to protect him from the noise.

b. Passenger

When the many transportation vehicles in operation which are designed for more than one person are considered, it becomes evident that being a passenger is very common. The noise exposure experienced by a passenger can be quite different from that of the operator and therefore merits independent examination.

c. Neighbor

Another social role is that of a neighbor, who maintains a fixed and rather permanent relationship to a noise source. (An air conditioning unit may be positioned so as to produce minimum noise disturbance to owners, but may be disturbing to neighbors.)

d. Bystander

For the three previous classes of people affected by noise (operator, passenger, and neighbor), it may be anticipated that the duration of exposure is usually considerable. However, in many situations the noise exposure is of relatively short duration for an individual but a larger number of people are impacted. The noise source may move through a community (a vehicle siren) or many people may walk past a stationary source (a construction site).

6.2. Nature of Effects

Traditionally, the effects of noise have been studied in terms of three major approaches, each one identified with a method of measurement -- physiological changes (both temporary and permanent), psychological attributes such as annoyance and, finally, task interference.

a. Hearing Loss

The most severe and damaging effect of noise exposure is permanent loss of hearing. Exposure to noise of sufficient intensity for long periods of time can produce temporary or permanent effects on the ability to hear. In some instances, excessive noise exposure leads to the destruction of the primary auditory receptors -- the hair cells in the ear. Changes in hearing experienced by the person suffering hearing impairment include distortions of the clarity and quality of sounds as well as losses in the ability to detect and understand sound. These changes can range from slight impairment to severe deafness.

b. Task Interference

The effect of noise on the performance of desired activities has received considerable research attention. The most unequivocal finding has been that noise can seriously impair speech communication. The performance of other complex tasks is also made difficult by noise, but it has been difficult to adequately define the levels of noise acceptability (or unacceptability) or to develop an adequate measure of task difficulty.

c. Annoyance

Many components associated with the disturbing characteristics of noise have been subsumed under the term of annoyance. An International Organization for Standardization study group defined annoyance as "that general quantity that emerges from the various sociological surveys that concern themselves with disturbance of various kinds around intense noise sources like aircraft." [3] Annoyance can result from sleep disturbance, interference with radio and TV listening, as well as many other subtle immediate and long term sociological, psychological and physiological reactions. Its definition and measurement have posed a major problem for researchers for many years.

7. Quantitative Description of Noise

A viable method of assigning noise ratings for products depends primarily on:

- a. The identification of those aspects of noise which are of concern in a particular situation.
- b. A well-defined procedure for quantifying noise emission.
- c. The ability to relate the results of measurement to human response.

7.1. Identification of Major Parameters

The most important decision to be made in any measurement process is the determination of what to measure. In noise abatement and control, there is not general agreement as to what quantities should be measured -- primarily because of inadequate data relating the impact of noise to the exposure which produced that impact.

a. Relationship to Effects

The attempt to associate particular characteristics of sounds with effects on people have had mixed results. Some clear-cut findings have been made -- notably those dealing with intensity, speech interference and some aspects of annoyance (high frequencies, pure tone components). However, other effects often cited are less tangible although they might be important. Interruption of activities such as sleep, work and recreation are often caused by noises which are unpredictable, or of short duration and need not be intense -- yet might constitute major problems for the individual from a psychological and physical health standpoint. For example, a person who is awakened regularly from sleep nightly by distant train whistles or aircraft overflights might be exposed to only moderate noise levels for a total of less than one minute during that time and still have a major noise problem. Noise effects therefore cannot readily be treated independently of the typical operating situation -- including who is exposed, activities being performed and, finally, identifying the major consequences of the noise.

b. Environment/Use Conditions

Other effects which cannot be readily dealt with in a rating scheme, but nonetheless are often cited, concern environmental factors and use conditions. For example, the low-frequency noise from trains penetrates great distances under particular weather conditions, thereby affecting a large number of people usually not bothered by this sound. Motorcycles and other vehicles are often operated in a manner that increases noise output rather than minimizes it. These are annoying both because of the noise intensity and the feeling that bystanders have that the noise is "louder" than is necessary.

7.2. Measurement Parameters

If history is a valid predictor of the future, there will be considerable disagreement as to particular rating schemes which should be used to describe the noise emission of products in terms which will appropriately predict human response to noise. The important measurement parameters for rating schemes are noise level, spectral quality, and temporal variation.

a. Sound Level

There is general agreement that, for a given spectrum shape and a given temporal variation, annoyance, hearing loss, task interference, etc., increase monotonically with increasing sound level. The difficulties and disagreements arise relative to the variation of noise level with frequency (i.e., the spectrum shape) and with time.

b. Spectral Quality

Although there are many schemes for predicting loudness, noisiness, annoyance, and so forth from the shape of a noise spectrum, it is perhaps fortunate that only a limited number of these have been given official status by regulatory agencies or standards bodies.

Relative to the common weighting networks used in sound level meters, it is reasonably well established that the A-weighted sound level (L_A) predicts most human response much better than the B-weighted (L_B) or C-weighted (L_C) sound level. D-weighted sound level (L_D) has been adopted specifically for aircraft noise. Both Stevens' and Zwicker's methods for computing loudness have been standardized, although significant modifications have been proposed by Stevens that are not reflected in the standardized version. Kryter's Perceived Noise Level (L_{PN}) enjoys official status through its use in calculating Effective Perceived Noise Level (L_{EPN}) for Federal aircraft certification (and has also been standardized by SAE and ANSI). The Air-Conditioning and Refrigeration Institute has a sound rating procedure somewhat similar to L_{PN} . All of these quantities are used to predict annoyance due to noise.

The Articulation Index (AI) has been standardized as a predictor of the extent to which steady noise interferes with speech communication (for male speakers only). Owing to the complexity of the Articulation Index, several versions of Speech Interference Level (SIL), based on the average of 3 or 4 octave band levels, have been proposed.

c. Temporal Variation

For transient noise events, there is need for a means to assign an overall noise rating to an event which includes appropriate consideration of the extent to which duration affects human response. The National Academy of Sciences-National Research Council Committee on Hearing, Bioacoustics,

and Biomechanics (CHABA) proposed a hearing damage-risk criterion for impulse noise (gunfire) which specifically includes measures of the duration of the pressure wave. Both the L_{EPN} and the single event noise exposure level (L_{SENE}) include corrections to account for duration. The Environmental Protection Agency has recommended the A-weighted average sound level (L_{eq}) and the day-night level (L_{dn}) as general descriptors of environmental noise.

DEPT AVIATION DIVISION

8. Consensus Procedures for Measurement Standards and Rating Schemes

8.1. Input from All Affected Parties

In writing measurement standards and establishing rating schemes, it is important to consider the contributions to standards-writing of all the affected groups. First, the voluntary standards bodies (for example, the American National Standards Institute, American Society for Testing and Materials) establish general standard test methods which reflect the most knowledgeable engineering and scientific practice. The trade associations, representing the manufacturers, must implement test methods, and therefore in addition to technical input evaluate practicality, in terms of available facilities, personnel, training, etc., in adopting or developing test methods for their purposes. Trade associations, however, are limited in the amount and kinds of information that can be channeled through them. Much of the information the Environmental Protection Agency will need to ensure that mandatory standards are reasonable, technologically feasible and economically worthwhile will be supplied by industry and be of a confidential and proprietary nature. Consequently, it will be necessary for the Environmental Protection Agency to communicate with individual manufacturers as well as with trade associations. Regulatory agencies, acting on behalf of, and with input from, the consumer, set legal levels for each class of product, levels which must be technically and economically reasonable for the affected industry. Obviously, to consider only a single element from this chain and ignore the contributions of the others, will markedly decrease the effectiveness of the standard or rating scheme.

8.2. International Trade

Several years ago the concept of standardization in Western Europe underwent changes that posed a serious threat to United States-European trade. These changes were the result of a projected "harmonization" program to eliminate intra-European technical non-tariff trade barriers caused by differences in product standards. It was clear that upon completion of the "harmonization" program, international trade within Western Europe would be virtually barrier-free and trade into Western Europe almost impossible[4].

To maintain U. S. viability in European trade, the United States delegation to the "Kennedy round" of trade negotiations has called for a new scheme called the General Agreement for Tariffs and Trade (GATT). This agreement has identified over 800 non-tariff trade barriers in existence today. In February 1971, a new stage of the GATT non-tariff barrier work was begun. Rather than face the overwhelming task of solving the whole program of non-tariff trade barriers, it was decided to concentrate on a few -- of which product standards is one area. Standards were chosen for attention both because of their growing importance and because it appeared that progress might be encouraged more readily in this area than in some of the others[5]. A draft code on product standards was written and in May 1975, was accepted as a basis for negotiation[6]. A more thorough discussion of this code is given in Appendix E.

9. Environmental Protection Agency Promulgation of Regulations

9.1. Special Requirements

This section highlights a few features to be considered in conjunction with the regulations (see Section 1) to be issued by the Environmental Protection Agency. Pertinent sections of the Noise Control Act of 1972 are reproduced in Appendix B.

a. Product Noise Emission Standards

This report directly addresses product noise emission standards.

b. Labeling

A meaningful label on a noise-producing product (or noise control product) is dependent upon the existence of an appropriate, reliable, and repeatable measure of the noise level that is reasonably well-tied to subjective response to the noise. Whether the measure is a sound power rating, a weighted sound level at some distance from the device, or a set of octave band sound pressure level data, the problem is the conversion of this technical acoustic data into a labeling system which will be understood by the public and will provide the appropriate amount and type of information for the non-technical audience it is intended to reach.

Basically there are two types of audiences -- the general public consumer and the business or industrial consumer. In general, the public will want a label that is simple and easy to understand to permit a comparison to be made between the noise expected from one device as opposed to another. The noise label then serves as a criterion, along with performance characteristics, aesthetic quality, safety features, cost, etc., which the consumer evaluates. Would he be willing to pay, for example, \$2.00 more for a blender that does not annoy him or interfere with his listening to his hi-fi system during the blender's operation? On the other hand, the business and industrial community will need additional information -- either from the label itself or from application material developed to accompany the label. For instance, it is not enough to know that you have purchased a "quiet" machine, because if this machine is improperly placed you still could have a noise problem. An example of this would be the building contractor who purchases the quietest air conditioning units available and then installs them in a location under a bedroom window or next to a patio. Even though the unit might be quiet, many complaints would be made due to loss of sleep or the deprived use of the patio due to annoying or speech-interfering noise. The label, or supplementary material, should provide the purchaser with enough information so that he has sufficient data to determine whether or not his equipment in situ will meet the requirements of those noise ordinances which affect him, be they occupational safety and health regulations or sound level restrictions at property lines.

Product labels can take various forms. Appendix E contains a discussion of some of the alternative methods which deserve consideration as possible noise labels. It should be noted that it was the general consensus of the advisory and industry groups which reviewed the initial draft of this report that noise labels should provide quantitative information as to the product's noise emission.

c. Low-Noise-Emission Product Certification Procedures

To be eligible for certification as low-noise-emission products, the measurement methodology and rating scheme should be established first. The major task is to decide what further noise reduction is necessary for a product to be certified and whether or not there could be several grades of certification with associated procurement costs. If several grades are established, the problems become very analogous to those discussed above relative to labeling. However, in an industry composed of many small firms, with little research and development capability, the economic cost of acoustical measurements may be a significant factor.

9.2. Technical, Economic, and Administrative Feasibility as It Relates to Measurement

Fair and effective noise regulations must be technically, economically, and administratively feasible and reasonable. Generally, people consider technical feasibility only in terms of the technology available to quiet a product adequately, the economical feasibility only in terms of the cost to do so, and, if they think of it at all, administrative feasibility in terms of enforcement of the regulations. However, the measurement methodology must also be feasible and reasonable. The scientific and technical knowledge, appropriate test facilities, and suitable instrumentation must be available to carry out noise measurements of adequate accuracy and precision at a practical cost. The measurement and rating methodology and the testing and quality control procedures should be suitable for reasonable monitoring by an agent of the regulating body.

These factors should relate to the characteristics of the particular industry, in selecting the measurement methodology for use in regulating a particular class of product. For example, the air conditioning industry has voluntarily set up a noise rating system based on one-third octave band sound power levels measured in a reverberation chamber -- measurements which require expensive test facilities, complex instrumentation, and technically sophisticated personnel.

9.3. Compatibility with Other Regulations and Needs

In promulgation of Federal noise emission regulations, care should be taken to select measurement methodology, rating schemes, labeling practices, etc., which complement, to the greatest extent practicable, other regulations and needs. For example:

- o Even if labeling requirements call for a single-number (or letter, or color) rating scheme, it might be appropriate for labels on industrial machinery to include octave-band data so the purchaser can select and design to meet Occupational Safety and Health Administration (OSHA) regulations. (While current OSHA regulations of occupational noise exposure are expressed in terms of A-weighted levels, spectral information is often needed for engineering design purposes.)
- o Similarly, since many local zoning ordinances are written in terms of octave band sound pressure levels at the property line, it might be appropriate for the noise labels on outdoor equipment to provide sufficient data to permit prediction of property-line octave-band sound levels.
- o Federal product noise emission standards should, wherever possible, utilize measurement methodology which is equivalent to, or compatible with, state and local operating regulations so a purchaser can determine the conditions under which he will be able to operate a device in a given locality.

Many other examples could be cited. The major point is to carefully consider all probable uses of a class of products and then structure the measurement and rating methodology so as to provide as much information as practical in a form to meet the purchaser's manifold requirements.

10. Recommended Operational Procedure for Generating Measurement Methodologies for Specific Product Classes

The recommended procedure for the efficient and timely generation of measurement methodologies for specific product classes is depicted in Figure 2.

Once a specific product class has been identified as a major noise source, the Environmental Protection Agency, or its designated contractor, would form a small ad hoc task group to provide key input data for the needed measurement methodology. This group would include, as a minimum, representatives of the Environmental Protection Agency, independent acoustical consultants, manufacturers and, where appropriate, users and representatives of other government agencies at the Federal, state and local level. Careful selection of task group members would ensure a broad spectrum of expertise including: detailed familiarity with the product category, its design and operation; knowledge of quality control and product testing; expertise in acoustics; and a familiarity with the regulatory process.

Following formulation of the task group, meetings would be held to determine the existence and relevance of data bases and measurement procedures appropriate to the specific product class in question. Three possibilities exist: (1) a data base and/or measurement procedure exists and is relevant, (2) a data base and/or measurement procedure exists but is not relevant, and (3) a data base and/or measurement procedure does not exist.

If the task group determines that the existing measurement procedure and attendant data base are relevant then the group would recommend to EPA that a program be conducted to validate the data base as to its accuracy and completeness.

On the other hand, if the task group determines that data bases and measurement procedures either do not exist or are not relevant then the group would recommend to EPA that an extensive investigative program be conducted to evaluate alternative measurement procedures and to establish the needed data base. Such an investigative program would include systematic variation of source operating procedures, source loading, test site characteristics, microphone locations and acoustic measurement procedures.

Following completion of the investigative and/or validation programs, the task group would reconvene and evaluate the results. On the basis of these results, they would prepare an outline for a draft measurement methodology. EPA, or its designated contractor, would then prepare a draft measurement methodology which would be circulated to all members of the task group and to a number of affected parties for comment.

Once the draft methodology had been completed, the task group would recommend to EPA a list of selected industry representatives who should be asked to carry out measurements in accordance with the draft standard. Not

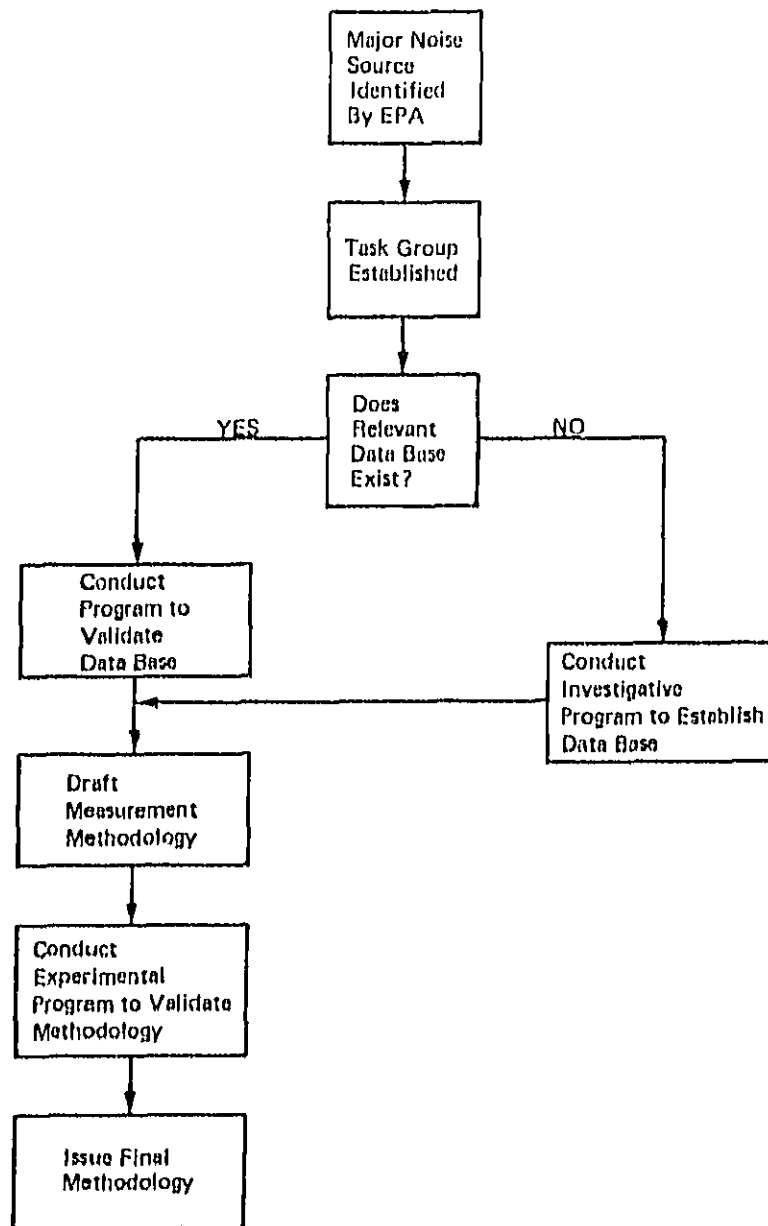

Figure 2. Recommended operational procedure for generating measurement methodologies.

only would this validate the measurement methodology, but it would also direct attention to key problem areas and obtain data in support of simplified measurement procedures.

At the same time, representatives from EPA, or its designated contractor, should visit a representative number of manufacturers or users of the major noise source in question to: (1) observe the use of the draft measurement methodology, (2) to discuss use conditions, operating procedures, and measurement procedures, and (3) if necessary, to conduct supplemental measurements.

Utilizing information gained via the above procedures, a final measurement methodology, with supporting documentation, would be prepared for each of the candidate major noise sources. To the greatest extent feasible, the final measurement methodology should draw upon, and be consistent with, existing and proposed voluntary measurement standards.

References for Part I

- [1] Grubbs, F. E., and Coon, H. J., On setting limits relative to specification limits, *Industry Quality Control* 10(5) (1954).
- [2] Private communication, R. H. Lincoln (Outboard Marine Corp., Milwaukee, Wisconsin) to W. A. Lenzure, Jr. (National Bureau of Standards, Washington, D. C.), January 11, 1973.
- [3] International Organization for Standardization Recommendation for Acoustics, Assessment of Noise with Respect to Community Response, R1996 (American National Standards Institute, New York, New York, 1971).
- [4] Simpson, R. O., The national impact of the GATT standards code, *Materials Research and Standards* 12(7) (July 1972).
- [5] Krauthoff, L. C., II, World standards for a world market, *ASTM Standardization News* 1(11) (January 1973).
- [6] Travaglini, V., Removing barriers to trade through GATT, *ASTM Standardization News* 3(11) (November 1975).

PART II CONTENTS OF MEASUREMENT STANDARDS

Part II of this report encompasses the subject matter of measurement standards for use in conjunction with noise emission standards to be promulgated by the U. S. Environmental Protection Agency. Part II is designed as a checklist for the evaluation of the suitability of a noise measurement standard for a particular class of products or, in the absence of a suitable standard, as a framework for development of one. The intent is to identify and discuss those factors which can impact on the accuracy, precision, and applicability of noise measurements.

Part II is structured similarly to a measurement standard. Each of sections 12 through 18 contains information relevant to a number of different types of measurement processes -- e.g., measurements of sound power and sound pressure; measurements made in anechoic, semi-anechoic, reverberant, and semi-reverberant spaces; measurements made outdoors and indoors; measurements made under laboratory and in situ conditions; measurements of overall weighted sound level and of sound pressure levels in frequency bands; etc. Obviously, much of this material will not be appropriate for any given measurement standard.

At the beginning of each section, the major factors to be addressed are outlined. The remainder of the section presents technical support material needed to facilitate an appropriate choice between alternative options. Information is given as to the type and size of errors which may result from different assignable causes. These data are not intended to be comprehensive or definitive, but merely illustrative.

Part II has been written with the assumption that it will be used by people trained in the physical sciences. Accordingly, basic concepts and terms are used without definition or discussion.

11. Purpose and Applicability

- Every measurement standard should include an introduction identifying (1) the group that prepared the standard, (2) the review process used for approval of the standard, and (3) a clear statement of the relationship of the standard with other standards.
- The scope of the measurement standard should be a concise abstract of its contents and should clearly delineate what is and what is not covered by the standard.
- The purpose of the measurement standard should make clear the reasons for establishing the standard.
- Existing standardized definitions should be utilized; those terms vital to the measurement standard which have special technical meaning or are unique to a given industry require definition.
- All publications noted in the measurement standard should be listed in a separate "References" section.
- There should be a clear statement of the acoustical quantity to be measured, e.g., sound pressure or sound power.
- The range of applicability should be clearly stated in the measurement standard (i.e., the types of noise sources (nature and size of source) and types of noise (steady and non-steady; periodic, aperiodic, random) for which it is applicable) and guidance should be provided as to the accuracy and precision which can be obtained utilizing the standard.

11.1. Introduction

Every measurement standard should include an introduction or foreword identifying the group that prepared the standard, including organizations officially represented on that group, and an indication, explicitly or by reference, of the review process used for approval of the standard. If the standard replaces, supplements, or complements one or more other standards, that should be made clear.

11.2. Scope and Purpose

The scope of a standard should be a clear and concise abstract of its contents. It should clearly delineate what is and what is not covered by the standard -- for example, classes of products to be included, types of noise to be measured, range of acoustic environments, and so forth.

The purpose of the standard should be briefly stated so as to make clear the main reasons for establishing the standard.

See also sections 11.4 and 11.5.

11.3. Definitions and References

Reference should be made to existing internationally or nationally recognized definitions where applicable. Unusual terms of measurement, abbreviations, and symbols used in the standard should also be defined. It is recommended that the International System of Units (SI) be used throughout the standard and that equivalent values expressed in customary U. S. units also be included when failure to do so would interfere with effective communications. In the case of key quantities, e.g., distance from the source to a microphone, it may be desirable to give the numerical value in the text in both SI and U. S. customary units. For other quantities, it may be preferable to refer to conversion factors in the "Definitions" section. For further guidance, the reader is referred to [1-3]¹⁰.

All publications referred to throughout the standard should be listed in a separate "References" section. Each reference should be up-to-date and should include all information required for clear and unambiguous identification of the reference. In referencing other standards, the full title of the document, its designation (and date of issue, if this is not part of the designation) and the name and address of the issuing organization should be given. If a standard has more than one official designation (e.g., an American Society for Testing and Materials standard which has been adopted as an American National Standard), all known designations should be included in the reference. It should be made quite clear whether the intention is to reference only a particular issue of a standard or whether, if a standard which is referenced is later revised, the latest revision is intended. If reference is to part of the document only, that part should be adequately identified so that in a later revision the pertinent material can be identified.

Throughout the text, the following abbreviated reference forms may be used:

Standards -- the name of the issuing organization and the designation of the document (e.g., American National Standard S1.13-1971)

Laws, codes, and ordinances -- title and number

Other publications -- these may be simply referenced by number, by author and year, footnoted, or the complete reference given in the text.

11.4. Acoustical Quantities to be Measured

Under "Scope and Purpose," there should be a clear statement of the acoustical quantity which is to be measured -- sound pressures at one or more particular locations, total sound power, or sound power plus directivity. If a frequency-weighted quantity (e.g., A-weighted sound pressure or

¹⁰Figures in brackets indicate the literature references at the end of Part II.

power level) is to be measured, this should be so indicated. Usually this will simply be stated in very brief form without need for justification. However, because of the prevailing arguments as to what quantity is most appropriate, a discussion is presented below.

Noise ratings are derived from acoustical measurements which fall into two groups:

- o Effective (root-mean-square), or instantaneous, sound pressure level
- o Sound power level, plus directivity if desired.

Some acousticians are quite adamant in their preference for expressing noise ratings in terms of sound power rather than sound pressure -- or vice versa. Since sound power is almost always computed from measured sound pressures, it is difficult to argue that sound power is inherently superior to pressure. However, the sound pressure resulting from a given source is strongly dependent upon the point at which the measurement is made and can depend upon the environment in which both the source and the measuring microphone are located. Sound power level is a measure of the total sound power radiated by the source in all directions and directivity is a measure of the spatial intensity distribution. Sound power and directivity are basically characteristics of the noise source and hence do not need to be specified in terms of any particular measurement distance (other than that measurements should be made in the far field). Sound power is less dependent on the environment in which the source is located than is sound pressure. However, both the radiated sound power and the directivity are influenced by nearby reflecting surfaces, such as floors and walls. In enclosed spaces, the sound power usually is less affected by the environment than is the sound pressure at distances far enough away from the source to be in the reverberant field.

As was mentioned above, the sound power usually must be computed from sound pressure measurements. This is accomplished simply and accurately in two limiting cases: (1) in the region of a free field beyond the near field, and (2) in a reverberant (diffuse) sound field. In such fields the sound power can be calculated from the mean-square sound pressure, averaged over an appropriate surface enclosing the source (free field) or averaged over the volume of the room (reverberant field). Close approximations to free-field conditions can be achieved in anechoic chambers, semi-anechoic chambers (i.e., free field over a reflecting plane), or outdoors. Approximately diffuse sound fields can be obtained in large, hard-walled reverberation chambers. To determine the directivity of the source, an essentially free-field environment must be used.

When acoustical data are expressed in terms of sound power, one should be able to assume that the data correspond to the far field around the source and that the sound power is based on measurements at a sufficient

number of angular positions to sample adequately the field in all directions or by adequately sampling a reverberant field. Thus one can have a fair degree of confidence in using the sound power to predict sound pressure at a particular location in a particular environment. If on the other hand, acoustical data are expressed in terms of sound pressure, these data should be accompanied with sufficient information regarding the measurement location and test environment to enable one to infer the extent to which the data may be used to predict sound pressure at other locations and in other environments. Compare the following statements:

The A-weighted total sound power level of the machine was found to be 93 dB re 1 pW.

The A-weighted sound pressure level of the machine, when resting on a hard reflecting plane, was found to be 69 dB re 20 μ Pa at a location 7 m from the center of the machine, at an angle of 45° relative to the axis of the machine, at a height of 1.5m above the supporting plane. No other reflecting surfaces were within 50m of the machine. Tests established that the measurement location was in the far field and that there were no significant variations in sound pressure near this location due to phase cancellation between the signal reflected from the supporting plane and the direct signal.

Note that the results of sound power determinations can be stated quite simply since measurement location need not be specified. A statement regarding local variations in sound pressure due to phase cancellation frequently would not be made but can be quite important (see Sec. 15). In the case of the statement of sound pressure level, there is no information about sound pressure in other directions. Sound power determination usually requires measurement of sound pressure levels at a number of microphone locations. Directivity information may be available if desired (provided, of course, the measurements were made under free-field conditions). Some of the arguments in favor of expressing noise emission in terms of sound power have been summarized by Lang and Flynn[4].

In spite of the above endorsement, sound power is frequently not the appropriate quantity to use for noise ratings. As stated above, sound power requires measurements in the far field of the source in a well-defined acoustic environment. The extent of the far field of practical sources at any given frequency is not accurately known. For a source whose radiating surface has a representative dimension, a , the near field is approximately circumscribed by the distances $2a^2/\lambda$ or $2a$, whichever is larger. Here a is the "dynamic" dimension of the source, which may vary considerably with frequency and can be estimated conservatively to be equal to the maximum source dimension, and λ is the

wavelength corresponding to the frequency of operation. Sometimes it is also recommended that measurements be made at least one wavelength away from the source. If measurements are made with the source located an effective distance, h , above a reflecting plane, measurements should be made at a distance away of at least $4h$. The limitation to distances greater than $2a^2/\lambda$ tends to be the most serious one. At a frequency of 10 kHz, for instance, the wavelength, λ , is only .034m. Assuming a source dimension of $a = 0.5m$, the measuring distance must be at least 15m. For real sources, the situation would rarely be as bad as this. The $2a^2/\lambda$ limitation is based on a source for which all points radiate coherently. In many products, there are a number of individual sources, a large number of vibrational modes are excited, there may be aerodynamically-generated random noise, and the source behaves more like an ensemble of small incoherent sources -- in such a case, the far field may begin very close to the source even at higher frequencies. Recent investigations[5-7] have demonstrated that an accurate determination of the sound power emitted may be derived from sound pressure measurements which are made quite close, say, one meter, to the machine whose noise emission is being measured. The validity of one-meter measurements has been confirmed for all of the sources studied that emitted broad-band noise without prominent discrete tones[5-7]. If such close-in measurements yield sufficiently accurate results, smaller test facilities may be used and ambient noise requirements may be relaxed.

Whether or not it is possible to make accurate sound power determinations, there are instances where it is distinctly preferable to characterize or rate machinery in terms of sound pressure. One of the most common of such situations is when the noise rating relates to an operator location. If the operator stays at a particular location, the sound pressure level at the position of his head is the most useful quantity to measure. If the operator moves around in some known area near to the machine, a spatial average of sound levels over likely operator locations (e.g., a path around the machine at ear level and arm's length from the machine) is appropriate. In some cases where an operator works near one of a large assemblage of machines, it may be necessary to know the close-in (operator positions) sound pressure for his machine and, in addition, sound power of the other machines in order to provide sufficient data to predict the total noise level at the operator positions.

One may be primarily concerned with the noise radiated in a particular direction so that total sound power information is not needed. Motor vehicle noise ratings, for example, may not require total sound power information, but only the sound pressure radiated to nearby communities. Of major concern is the noise radiated to the side of the vehicle, while noise radiated to the front, back, and top is of much less concern and may be difficult to measure for a moving source. Thus sound pressure at a far-field sideline position is a logical measurement which relates directly to the noise levels in communities.

Sound pressure is the preferred quantity for sources, such as firearms, which produce impulsive noise. Here the instantaneous sound pressure and its

time history are required in order to characterize adequately the sound and assess the potential noise hazard.

In general, sound pressure is appropriate if the listener location is well defined, the transmission to the listener does not differ much among typical applications, and, if it is desired to extrapolate the data to other locations, typical applications are such as to permit this to be done with adequate confidence. Sound power is usually more appropriate if information is needed to predict sound pressure in a variety of environments which significantly affect the resultant sound pressures. All other things being equal, sound power data are preferred for machines which are small enough to be tested under laboratory conditions; if directivity is a significant factor, however, reverberation room measurements of sound power would not be appropriate since no directivity information can be obtained.

11.5. Applicability

a. Types of Noise

The measurement standard should clearly state the types of noise for which it is applicable. This is important since some measurement procedures are not at all appropriate for certain types of noise. The following discussion of classification of noise by type is adopted from American National Standard Methods for the Measurement of Sound Pressure Levels, S1.13-1971[8].

The noises usually encountered in practice are classified as steady or nonsteady noise.

(1) Steady Noise. The level of a steady noise remains essentially constant (that is, fluctuations are negligibly small) during the period of observation. (See section 8.4 of [8] for a discussion of observation times). To the typical observer, a change in noise level of less than one decibel is not likely to be detectable while a six decibel change would be considered significant. If the average noise level is relatively constant but the spectral distribution of the sound changes during the period of observation (as determined by listening), the noise shall be classified as nonsteady.

(a) Steady Noise Without Audible Discrete Tones. This type of noise is frequently referred to as "broad-band" noise; prominent discrete components and narrow-bands of noise are absent. The plot of pressure spectrum level versus frequency is without pronounced discontinuities.

(b) Steady Noise with Audible Discrete Tones. This type of noise has components at one or more discrete frequencies which have significantly greater amplitudes than those of the adjacent spectrum. Clusters of such components or narrow-bands of noise may be observed.

The spectrum obtained with a narrow-band analyzer has sharp peaks (prominent single-frequency components) or steep gradients (narrow bands of noise).

(2) Nonsteady Noise. The level of a nonsteady noise shifts significantly during the period of observation. This type of noise may or may not contain audible discrete tones. The classification of nonsteady noises depends upon the period of observation which must be defined for each measurement.

(a) Fluctuating Noise. The sound pressure level varies over a range greater than six decibels with the "slow" meter characteristic and does not equal the ambient level more than once during the period of observation. Alternatively, the noise may fluctuate between two or more steady levels six or more decibels apart when measured with the "fast" meter characteristic of a sound level meter. Fluctuations may occur because of beats between two or more audible discrete tones having nearly the same frequency.

(b) Intermittent Noise. The sound pressure level equals the ambient level two or more times during the period of observation. The period of time during which the level of the noise remains at an essentially constant value different from that of the ambient is of the order of one second or more.

(c) Impulsive Noise (bursts). Impulsive noise has brief excursions of sound pressure (acoustic impulses) which significantly exceed the ambient environmental sound pressure. The duration of a single impulse is usually less than one second. Two subcategories of impulsive noise are:

Isolated Bursts. One or more bursts occur during the period of observation. The envelope of the burst waveform may be that of a decaying transient or it may be of essentially constant amplitude, for example, a tone burst. The burst spacing (time interval between bursts) is such that each burst is individually distinguishable with a sound-level meter.

Quasi-Steady Noise. A train of two or more bursts occur during the period of observation. Individual bursts in the train may have equal or unequal amplitudes and the burst spacing (time interval between bursts) may be uniform or nonuniform. As the burst repetition rate increases, the resolution of individual bursts by a sound-level meter becomes difficult; the noise is then classified as quasi-steady.

In specifying the measurement of impulsive noise, it is important to be very clear as to the quantity desired: peak instantaneous sound pressure or peak root-mean-square sound pressure averaged over a short, and specified, averaging time.

Examples of different types of noise sources are given in Table 2.

The acoustic environment has a strong influence on the types of noise which can be measured therein. Because a reverberant, or semi-reverberant, room acts to average sound pressures over time, information cannot be obtained concerning the short-term temporal variation of noise emission. Particular caution is necessary in reverberant room measurements if the noise emitted by the source contains significant discrete frequency and/or low frequency components (see sections 12.2 and 15).

All types of noise can be measured in an anechoic space or a hemi-anechoic space (i.e., free field conditions over a reflecting plane). In conducting measurements over a reflecting plane, particular caution is required if the noise emitted by the source contains significant discrete frequency components or if a narrow-band frequency analysis is desired (see sections 12.2, 12.6 and 15).

Table 2

Examples of Sources of Different Types of Noise

Steady	Nonsteady
<u>Without Audible discrete tones</u>	<u>Fluctuating</u>
Distant city	Heavy traffic (nearby)
Waterfall	Pounding surf
<u>With Audible discrete tones</u>	<u>Intermittent</u>
Circular saw	Aircraft fly-over
Transformer	Automobile passing by
	Train passing by
	<u>Impulsive Isolated Bursts</u>
	Drop forge hammer
	Dog barking
	Pistol shots
	Door slamming
	Electrical circuit breaker
	<u>Quasi-steady Noise</u>
	Riveting
	Pneumatic hammer
	Machine gun

Different types of noise may require different types of instrumentation (see section 13). Accordingly a measurement standard must call for specific instrumentation performance characteristics; that standard will generally not be suitable for all types of noise.

Departing now from the classification of noise by type as given in American National Standard S1.13-1971, it is also useful to classify noise as being deterministic or nondeterministic. Deterministic signals can be described as an explicit function of time; nondeterministic signals cannot. Deterministic signals are periodic or aperiodic. Periodic signals repeat themselves in their entirety over some time interval. Aperiodic signals are every other type of deterministic signal. Nondeterministic signals, also referred to as random signals, may be described statistically. The probability function for time-varying wave forms indicates the relative frequency of occurrence of the various instantaneous values of the wave form.

The accuracy with which an acoustical signal can be measured depends upon, among other things, the rise time and the averaging time of the measurement system. The signal must be "looked at" long enough for the instrumentation to respond and, in the case of nondeterministic signals, long enough to obtain a suitable average (see section 13).

b. Nature and Size of Source

A noise measurement standard should include an indication of the types of noise sources encompassed. This should include such factors as stationary or mobile, size of source, allowable operating characteristics, etc.

c. Measurement Uncertainty

A noise measurement standard should provide guidance as to the measurement uncertainty which can be tolerated in each regulatory situation. To have operational meaning, the uncertainty of a measured value must be given relative to some actually achievable and nationally accepted reference. To do this, a clear statement of what would constitute the nationally accepted answer is needed. In some cases references to standards as maintained by a national laboratory may be sufficient; in others the reference may be a consensus of many laboratories.

The current International Organization for Standardization standards and draft standards for determination of sound power emitted by stationary noise sources associate with each document [9-15] one of the following grades of accuracy: precision, engineering, and survey. Within each document a statement such as the following is made [14]:

Measurements made in conformity with this International Standard tend to result in standard deviations which are equal to or less than those given in tables 2 and 3. The standard deviations of tables 2 and 3 reflect the cumulative effects of all causes of measurement uncertainty, excluding variations in the sound power of the source from test to test....

Table 2. Uncertainty in determining sound power levels of sound sources in anechoic rooms

Octave Band Center Frequencies Hz	One-Third Octave Band Center Frequencies Hz	Standard Deviation of Mean Value dB
125 to 500	100 to 630	1.0
1000 to 4000	800 to 5000	0.5
8000	6300 to 10000	1.0

Table 3. Uncertainty in determining sound power levels of sound sources in semi-anechoic rooms

Octave Band Center Frequencies Hz	One-Third Octave Band Center Frequencies Hz	Standard Deviation of Mean Value dB
125 to 500	100 to 630	1.5
1000 to 4000	800 to 5000	1.0
8000	6300 to 10000	1.5

This particular example corresponds to precision measurements in anechoic and semi-anechoic environments. Analogous tables are contained in the other draft standards. These documents also include discussions of the major causes of uncertainty.

Whenever possible, the standard should specify the components of variance which should enter into the uncertainty statement and the means for determining a realistic limit to the offset of the process from the "accepted" process as defined in the standard. In addition, the standard should specify the type of evidence needed to establish that the measurements arise from a measurement process which is in a state of control (i.e., has predictability).

If a noise regulation for a particular class of products requires all noise measurements to be made in accordance with the same measurement standard, and if the inter-laboratory reproducibility is excellent, that may be acceptable even if a systematic bias is suspected since that bias would affect all measurements similarly. On the other hand, a measurement process might be capable of producing results that would average out, over a very large number of measurements, to be quite accurate but the imprecision could be so large as to be unacceptable. In general, and if sufficient knowledge exists, a statement such as the following should be made:

Measurements made in conformance with this standard tend to result in a standard error of X dB and a systematic error of not more than ±Y dB.

Provided that separate statements of imprecision and systematic error are included, it is acceptable to present a statement placing bounds on the

inaccuracy, i.e., the overall uncertainty of measured values. In general, the bounds indicating the overall uncertainty should not be numerically less than the corresponding bounds placed on the systematic error outwardly increased by at least three times the standard error. For example:

...result in an overall uncertainty of ± 6 dB based on a standard error of 1.0 dB and an allowance of ± 2.0 dB for systematic error.

Considerable care must be taken in selecting values for the standard error and systematic error which are appropriate for use in a measurement standard. The standard error should correspond to the reproducibility among a number of laboratories, rather than the repeatability in a given laboratory. Similarly, the allowance for systematic error should correspond to that of the measurement standard as realized in a given laboratory. Thus, the statement just prior to this paragraph should be interpreted as indicating that, if a very large number of laboratories were to carry out measurements on a given noise source, approximately 99% of the laboratories would obtain values within ± 3 dB (corresponding to 3 standard errors) of the mean of all the values and that mean value (assuming enough laboratories participated so that the mean of the values obtained did not differ significantly from the mean of an infinite population of laboratories) would not differ from the "true" value by more than ± 2 dB.

Neither the standard error nor the systematic error bound are easy to obtain. Selection of appropriate values should be carefully considered by the group preparing the standard. A worthy, but difficult goal is to specify the test environment, the source-operating procedure, and the measurement and calibration procedures to maximize both accuracy and precision while minimizing the time, difficulty, and cost of conducting the test.

All in all, it is the "quality" of measurements which is at issue. This "quality" depends on a variety of factors including the operator, the environment, the item or quantity being measured, the instrument, etc. Specification on the instrumentation (e.g., traceability, re-calibration schedule, etc.) particularly when the results are done under the extremely restrictive conditions of a laboratory may not give valid indications of the performance of the instrument in routine use. In regulatory measurement, it is particularly important that the focus be on the correctness of individual measurements, because of the "cross-examination" to which the measurement will be submitted in legal proceedings. The decision as to the adequacy of measurement should not be allowed to depend solely on *pro forma* traceability requirements relating to the scientific evidence which is needed to determine the uncertainty of measurement (see Appendix C).

12. Acoustic Environment

- The measurement standard should specify and provide criteria for the evaluation of the allowable test environment(s), e.g., anechoic, hemi-anechoic (free-field over a reflecting plane), reverberant and in situ.
- For those cases where the background noise is significantly, but less than 10 db below the noise being measured, the measurement standard should provide correction factors.
- The measurement standard should include restrictions on external factors which can affect the sound pressure level at a particular point or the accuracy of the measurement of that sound pressure level. Allowable ranges of temperature, barometric pressure, humidity and wind over which measurements may be made as well as restrictions on vertical and horizontal (ground plane) reflecting surfaces and corrections for the effects should be included wherever possible.

In Section 5.2, a brief discussion was given of the effect of the environment on the noise levels produced by various sources. From this discussion it should be clear that meaningful measurements of noise emission generally can be made only in a well-characterized acoustic environment. Whenever the noise source can be moved readily into a laboratory, or other controlled environment, it is generally preferable to make acoustical measurements there rather than to be subject to the vagaries of nature and the need to characterize a new acoustic environment every time a test is carried out at a different location. Due to the size or mobility of many noise sources, however, it is frequently necessary to conduct measurements outdoors at a particular test site or, either outdoors or indoors, in situ.

12.1. General Requirements

Four basic test environments frequently are used for acoustical measurements:

Anechoic -- An anechoic (meaning "without echo") environment is usually obtained in an indoor chamber, or room, in which the walls, floor, and ceiling are specially treated to absorb virtually all of the incident sound energy. An anechoic space can also be obtained outdoors, by suspending the test specimen well away from the ground or other reflecting objects. An anechoic space can sometimes be well approximated in a large room, without special acoustic treatment of the room boundaries, if measurements can be made close enough to the source that there is negligible contribution from reflected sound energy.

In an anechoic environment, "free field" conditions prevail and the noise emission characteristics of a source can be determined simply from measurements of sound pressure in the far radiation field (see Sec. 15) of the source. In general, any type of noise signal can be measured in an

anechoic environment. A particular advantage of an anechoic environment is that the directivity of the radiated sound field can be measured. Several limitations to the use of anechoic environments are: (1) the high cost of anechoic chambers, (2) difficulty in suspending large sources well away from any reflecting surface, and (3) difficulty in providing for operating loads, heat loads and exhaust emissions.*

Hemi-Anechoic -- A "hemi-anechoic" environment is one in which free-field conditions exist in the half-space on one side of a totally or partially reflecting plane. Usually a hemi-anechoic space is the free space above a hard, reflecting, horizontal surface but the concept can be extended to include free-field measurements near any partially reflecting surface. A hemi-anechoic space can be obtained in an indoor chamber with the walls and ceiling acoustically treated as in an anechoic chamber but with the floor acoustically hard and reflecting. A hemi-anechoic space can also be obtained outdoors, with the test specimen resting on or above a paved surface. Occasionally outdoor measurements are made over a partially reflecting surface such as grass.

In a hemi-anechoic space, as in an anechoic space, noise emission is determined from sound pressure measurements in the far radiation field of the source. Measurements are complicated, however, by interference effects due to the combination of direct sound waves and waves from the reflecting plane. This results in local maxima and minima in the sound field and considerable spatial sampling often is required to obtain meaningful results (see Sec. 15). In general, any type of noise signal can be measured in a hemi-anechoic environment. Directivity information can be obtained under conditions typical of use conditions for many types of equipment -- e.g., over a reflecting plane. There is no particular difficulty in supporting or operating large or mobile equipment. In conducting outdoor measurements considerable difficulties can arise due to wind, rain, humidity and temperature.

An extension of the hemi-anechoic environment is a free field adjacent to two or three intersecting reflecting surfaces. This could be useful when a product is normally so installed.

*The time required to make measurements at a large number of microphone locations, in order to obtain adequate spatial averaging in an anechoic environment, has been indicated as a reason for preferring reverberant-field measurements to free-field measurements. However, as the understanding of the requirements of reverberant room sound power determination has increased, it has become clear that many microphone locations, and frequently several source locations, also are needed for adequate sampling in reverberant fields. If only A-weighted sound power, rather than spectral information, is needed, anechoic chamber measurements may be easier than reverberation chamber measurements since, in reverberation room measurements, it usually is necessary to determine sound power versus frequency and compute A-weighted power rather than measuring A-weighted levels directly as can be done in an anechoic chamber.

Reverberant -- Reverberant field measurements are carried out in a room with acoustically hard walls (i.e., low sound absorption) such that sound waves undergo many reflections before being absorbed. Reverberation rooms are typically equipped with stationary or moving diffusers to increase the uniformity of the reverberant sound field.

In a reverberation room, one measures sound pressure level and computes total sound power, the computation being based on the premise that the mean-square sound pressure averaged in space and time is (1) directly proportional to the sound power output of the source, (2) inversely proportional to the total absorption in the room, and (3) otherwise dependent only on the physical constants of air density and velocity of sound. Reverberant room methods are particularly advantageous for sources which produce steady noise and for which directivity information is not required.

Noise measurements in a reverberation room are dependent upon accurate measurement of the sound energy density, in the frequency bands of interest, in the reverberant field of the room with the noise source in operation. In order to obtain such accurate measurements it is desirable for the room volume to be sufficiently large (see Sec. 12.2) that many normal modes are excited in the room. At low frequencies and/or when the room is excited by pure tones or very narrow bands of noise, it is common for only a few modes to be excited and accurate measurement of energy density requires very extensive sampling of the sound field, preferably with the use of moving diffusers.

In Situ -- Certain types of equipment cannot, for practical reasons, be operated outdoors or in a laboratory environment. When the noise emission of a source must be measured in situ, it is highly desirable to utilize procedures which approach, as nearly as possible, one of the three cases just discussed. Two of the recent Draft International Standards for sound power determination [13,15] include provisions for correcting for a less-than-ideal acoustic environment. The need for such corrections would almost always imply a degradation of measurement accuracy.

12.2. Criteria for Adequacy of the Test Environment

This section includes more detailed discussions of the criteria which each of the above four types of acoustical environment should meet.

a. Anechoic Environment

The Draft International Standard for precision determination of sound power in an anechoic chamber [14] states (Annex G) that "the volume of the test room shall be large enough so that the microphones can be placed in the far radiation field of the sound source under test, without being too close to the absorptive surfaces of the test room." It is instructive to consider briefly the measurement error that might result due to reflections from the wall of an anechoic chamber.

Consider a situation such as shown in Figure 3, with a sound source in an anechoic chamber and a measuring microphone in the far radiation field of the source. It is assumed that the source emits a spherical sound wave at an angular frequency $\omega = 2\pi f$. The instantaneous pressure of the emitted wave can be expressed as

$$p_e(r, t) = \frac{P}{r} \cos [\omega(r/c - t)], \quad (1)$$

where P is the amplitude (Pa) of the pressure at a unit radial distance, $r = 1$ m from the source, t is time (s), and c is the velocity of sound (m/s) in the medium. The wave reflected from the chamber wall may be approximated by a wave emitted from an image source a distance L to the right of the effective location of the chamber wall.* The instantaneous pressure of the reflected wave can be expressed as

$$p_r(r', t) = \frac{RP}{r'} \cos[\omega(r'/c - t) + \phi], \quad (2)$$

where r' is the distance from the image source to the measurement location, R is the magnitude of the pressure reflection coefficient of the chamber wall for normally-incident plane waves, and ϕ is a phase angle which depends on the acoustical impedance of the chamber wall. For normal incidence, $r' = 2L - r$. The amplitude of the total pressure, $p = p_e + p_r$, will be between the following limits:

$$\frac{P}{r} \left[1 - \frac{rR}{r'} \right] \leq |p| \leq \frac{P}{r} \left[1 + \frac{rR}{r'} \right], \quad (3)$$

the lower limit corresponding to destructive interference and the upper limit corresponding to constructive interference.

*The analysis given in this section is fairly accurate for estimating the effect of the reflecting plane in hemi-anechoic measurements or the effects of the walls in reverberation measurements. It is less accurate for "soft" walls such as those in an anechoic chamber. In addition, since the absorptive lining of an anechoic chamber has considerable thickness, the "effective location" of the wall is uncertain. Thus the analysis which follows is intended to qualitatively show effects but should not be taken too seriously in a quantitative sense. More exact analyses of the sound field due to a point source near a partially reflecting boundary are given by [16,17], which also reference earlier work.

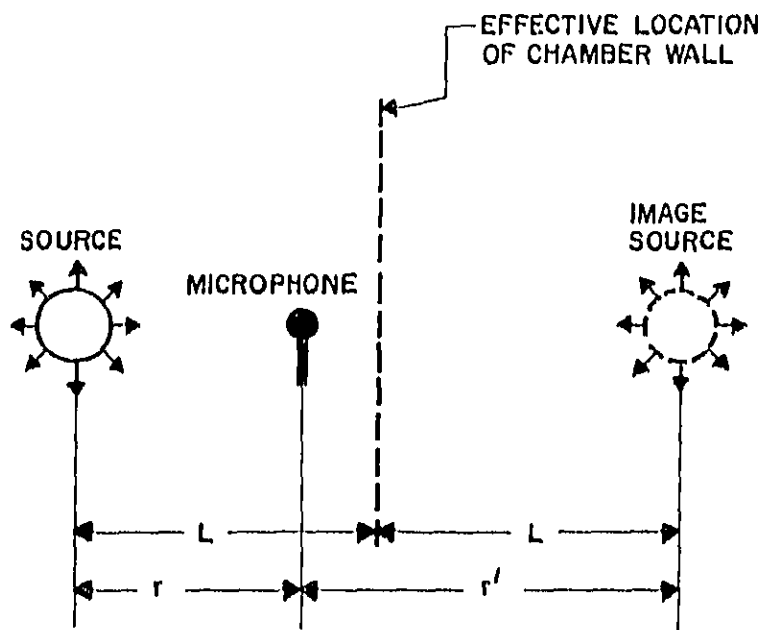

Figure 3. Schematic representation of a sound source in an anechoic chamber. The sound field produced by a source and its "image" only approximately represents the actual sound field.

In terms of mean-square pressure ratios,

$$\left[1 - \frac{rR}{r'}\right]^2 \leq \overline{p^2}/\overline{p_e^2} \leq \left[1 + \frac{rR}{r'}\right]^2. \quad (4)$$

Converting to sound pressure levels, the difference, ΔL , between the measured level and the level in the absence of reflections is bracketed by:

$$20 \log \left[1 - \frac{rR}{r'}\right] \leq \Delta L \leq 20 \log \left[1 + \frac{rR}{r'}\right], \quad (5)$$

where "log" designated the common logarithm (base 10) and where rR/r' represents the ratio of the magnitude of the reflected pressure, at any r , to the magnitude of the incident pressure, at the same r . Thus the measured deviation of the pressure from that of a spherically spreading wave depends on the product of two independent, non-dimensional parameters, R , and r/r' . R depends on the wall impedance only while r/r' accounts for the reduction in the reflected pressure at any point r due to the spherical spreading of the pressures from the real and image sources.

Defining

$$\Pi_R \approx \frac{rR}{r'}, \quad (6)$$

the range of the maximum sound pressure level deviations from a spherically spreading wave becomes, from eq. (5),

$$20 \log [1 - \Pi_R] \leq \Delta L \leq 20 \log [1 + \Pi_R]. \quad (7)$$

It is customary to define an energy absorption coefficient, α , which is the ratio of the absorbed energy to the incident energy. This is related to the pressure reflection coefficient by

$$\alpha = 1 - R^2; \quad (8)$$

similarly, a local measure, at r , of the energy lost due to wall absorption and spherical spreading is

$$\Pi_\alpha \equiv 1 - \Pi_R^2 \approx 1 - \left(\frac{rR}{r'}\right)^2. \quad (9)$$

When measurements are made with the microphone approaching the chamber wall, $R' \rightarrow R$ and $\alpha' \rightarrow \alpha$. Making measurements with the microphone nearer the source is equivalent to having a lower pressure reflection coefficient, or higher energy absorption coefficient, for the chamber walls.

The limits of eq. (7) are plotted vs. Π_R and Π_α in Figure 4 for the case shown in Figure 3, $r' = 2l - r$.

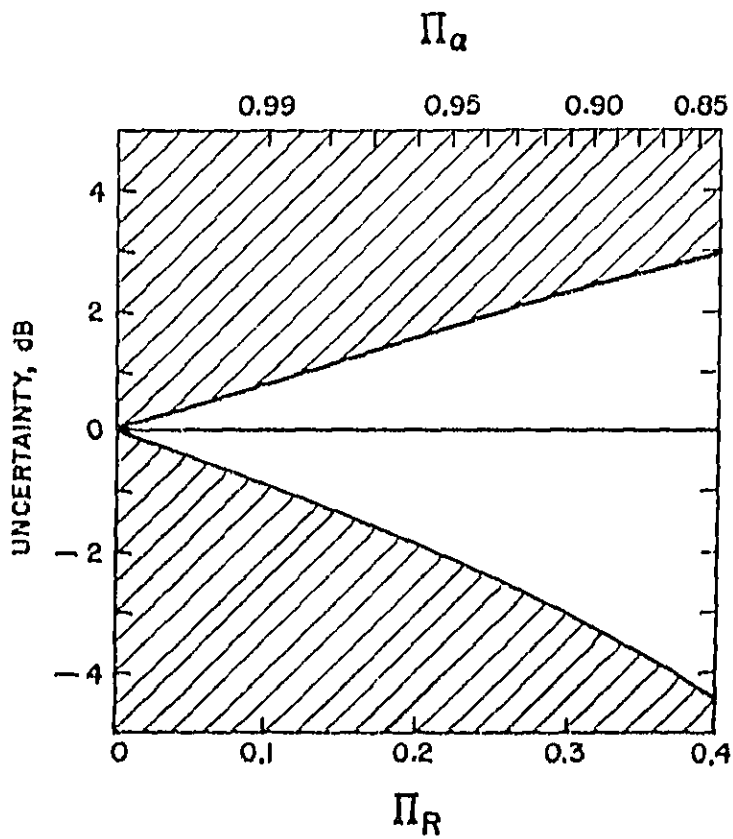

Figure 4. Maximum range of uncertainty in the sound pressure level in an anechoic chamber as a function of Π_R and Π_a , defined in the text (for single wall, normal incidence).

A standard for noise measurements in an anechoic chamber should provide guidelines for constructing a suitable chamber and specify criteria for ascertaining its adequacy (see Annexes A and G of [14]).

The usual procedure for determining the adequacy of an anechoic chamber is to measure the pressure falloff as a microphone is moved a distance, r , away from a source which has been selected so as to radiate essentially a spherical wavefront so that the sound level should fall off as $L = L_0 - 20 \log r$, where L_0 is the sound level at unit distance from the acoustic center of the source (assuming that one is in the far field at a unit distance) -- this corresponds to a 6 dB decrease in sound pressure level for every doubling of the distance from the source. Returning to eq. (6), it is illustrative to plot the sound level versus measurement distance from the source. This is done in Figure 5 for $R = 0.2$ ($a = 0.96$); the values selected for other parameters are given in the figure caption.

As indicated previously, the analysis above is only approximately correct for real anechoic chambers. Particular difficulties could occur in some instances, for example:

- microphones placed near room edges or corners could receive reflections off two or three walls thus increasing the error
- highly directional sound sources can cause particular problems due to sound emitted from the "louder" side of the source being reflected into microphone locations on the "quiet" side of the source.

An additional, and quite useful method for checking for unwanted reflections in anechoic chambers is to use a pulsed sound source or a correlation technique to determine not only the magnitude of the reflected energy but also the surface (e.g., supporting structures) from which the sound is being reflected.

The principal limitations on microphone locations in an anechoic chamber are (1) to get the microphone far enough away from the source to be in the far radiation field (see Sec. 15) and (2) to keep at least a quarter-wavelength, at the lowest frequency of interest, away from any part of the absorptive lining of the chamber to ensure that the sound pressure does not start to fall off rapidly due to the proximity of the absorptive material.

Useful references concerning the design and qualification of anechoic chambers include [18-26].

b. Hemi-Anechoic Environment

Qualification of a hemi-anechoic environment is essentially the same as that of an anechoic environment. The test source generally should be placed as close to the reflecting plane as possible to promote spherically divergent waves and thus minimize the influence of reflections from the plane.

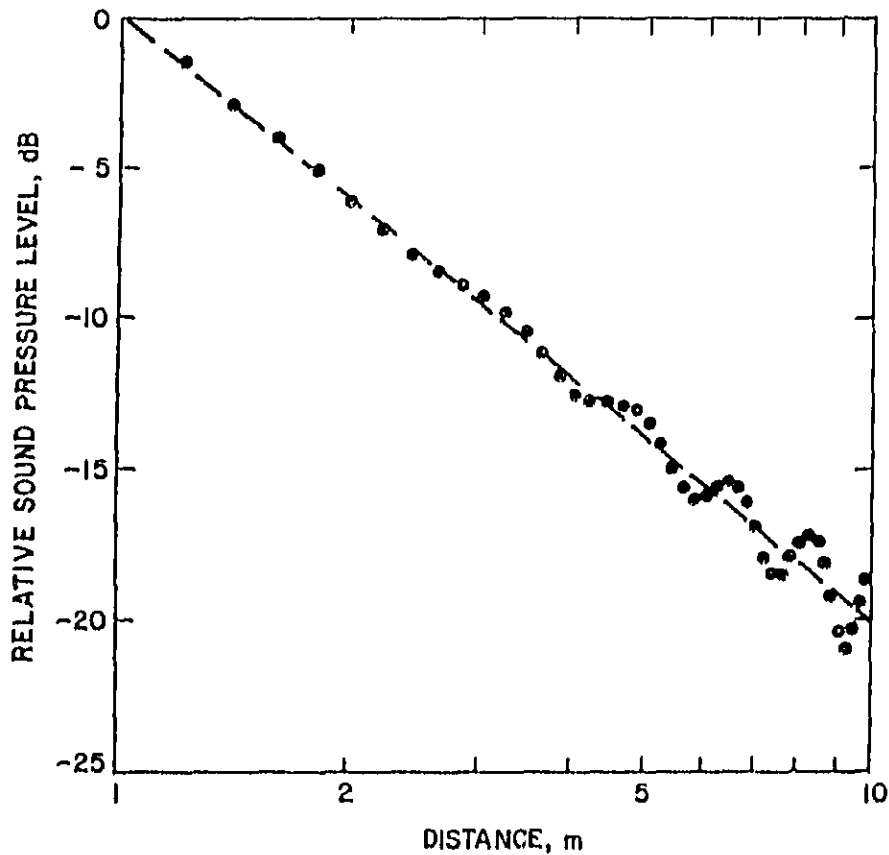

Figure 5. Hypothetical variation of sound pressure level versus distance as one wall of an anechoic chamber is approached. The dashed line indicates the fall-off (inverse square law) that would be expected in the absence of any reflections from the wall. The points were computed from the sum of eqs. (1) and (2) assuming $f = \omega/2\pi = 100$ Hz, $\phi = \pi$, and $R = 0.2$. The effective location of the chamber wall was taken as 10 m from the source.

REF ID: A61622

In addition to measuring the falloff of sound pressure with distance to determine the effectiveness of the five absorbing surfaces, it is necessary to check the reflectivity, or absorption of the reflecting plane.* The current Draft International Standards for both engineering[13] and precision[14] determinations of sound power in a free field over a reflecting plane call for the normal-incidence energy absorption coefficient, α , to be less than 0.06 ($R > .97$). This criterion normally would be met for dense concrete but the absorption might be too large in the case of unscaled asphalt pavings or certain types of floor coverings.

An indication of the reason for setting what may seem to be a rather strict requirement on the absorption of the reflecting plane follows from an extension of the analysis given in the previous section. Consider Figure 6, which shows a spherical source located above a reflecting plane. The microphone is no longer required to be directly between the source and the image source. With r and r' defined as shown in Figure 6, eqs. (1) through (9) remain valid, for a locally-reacting plane. The limits of eq. (5) are shown in Figure 7, plotted against both R and α with r/r' as a parameter. The upper limit on the measured sound pressure level is seen to be rather insensitive to the value of α since when the reflected signal is in phase with the direct signal and $r/r' \rightarrow 1$, the combined signal level can be at most 6 dB above the direct signal. However when the reflected signal is out of phase with the direct signal, the combined sound pressure $\rightarrow 0$ as $r/r' \rightarrow 1$ and $\alpha \rightarrow 0$. In order to be in the far radiation field (see Sec. 15), it is generally necessary that $r/r' \rightarrow 1$ so the sound level in regions of phase cancellation depends strongly on the value of α . For a source which radiates uniformly in all directions, requiring α to be less than about 0.06 ensures that the sound level in such regions will be sufficiently below the level in regions of phase reinforcement that no significant error, relative to the levels corresponding to a perfectly-reflecting plane, in the measured noise emission will occur (provided, of course, measurements are made at enough locations to ensure adequate spatial averaging). For highly directional sources, still stricter requirements on α might be needed.

The normal-incidence energy absorption of the material constituting the reflecting plane should be measured, for example, in accordance with[27]. Measurement of such low absorption coefficients is difficult by an impedance tube technique and care is required to obtain accurate data. A direct measurement of the pressure reflection coefficient might be preferable, for example by pulse or correlation techniques, but no current standard method of measurement exists.

*In the case of outdoor measurements, of course, there will be no walls and ceiling to be concerned with. However, site qualification is very useful to determine the influence, if any, of nearby reflecting or absorbing surfaces.

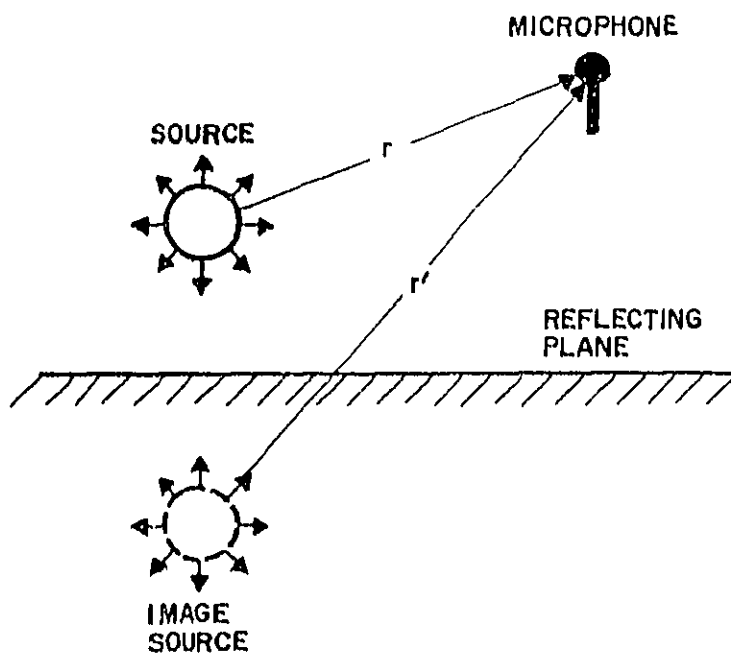

Figure 6. Schematic representation of a sound source in a free field above a reflecting plane.

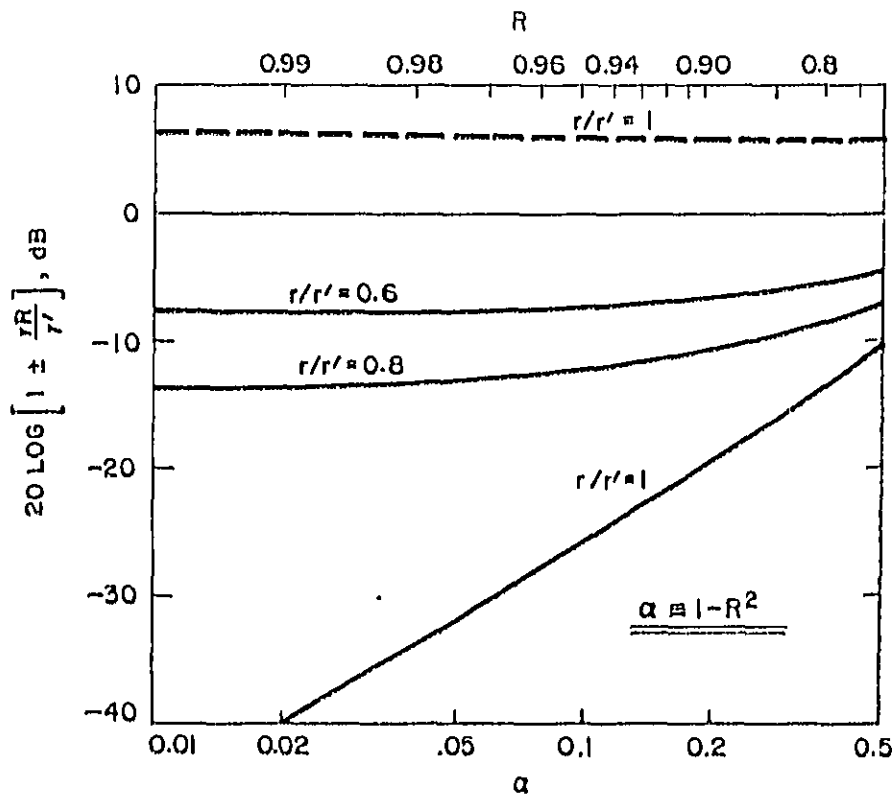

Figure 7. Limits for the effect of the image source (see Figure 6) on the observed sound pressure level as a function of the absorption coefficient of the reflecting plane with r/r' as a parameter. The solid lines correspond to destructive interference while the dashed line corresponds to constructive interference.

REF ID: A68 481 5 0000

If the reflecting surface is not an integral part of the hemi-anechoic environment care must be taken to ensure that noise sources cannot excite the reflecting surface into vibration of such magnitude as to radiate significant sound energy. If there is any question that this might occur, acoustical and/or vibration measurements should be made to estimate the energy radiated by (as opposed to reflected from) the reflecting plane.

Corrections for the influence of the acoustic environment, other than the major reflecting plane, are discussed in Section 16.7.

c. Reverberant Environment

Particularly in the case of noise measurements in reverberant environments, it is difficult to separate the adequacy of the test environment from the adequacy of the entire measurement process. In Section 15, attention will be directed to such factors as the variation in sound power output due to source location, spatial variation of sound pressure, and the use of reflecting elements to increase the "diffuseness" of the sound field. In the present section the properties which the room should have will be considered.

Early workers developed the basic reverberation room theory using certain simplifying assumptions: (1) uniform, diffuse distribution of sound energy throughout the room at any instant; (2) equal probability of propagation of sound in all directions; (3) continuous absorption of sound by the room boundaries. The assumptions were those of geometrical acoustics, in which sound energy is considered to travel in rays and all wave phenomena are neglected.

The sound energy in a reverberant room can be considered as two components, that in the direct field of the source, which has not yet suffered a reflection from a room boundary, and that in the "reverberant field", which can be somewhat arbitrarily defined as that sound which has undergone one or more reflections [28, p.311]. Of the total power, W , emitted from the source a fraction, $a_0 W$, will be absorbed at the first reflection, leaving a total power of $(1 - a_0)W$ in the reverberant field. Here the absorption coefficient, a_0 , corresponds to an appropriate average over the surfaces of the room, with account being taken of variations in the absorption coefficient as a function of location and angle of incidence. Note that a_0 does not correspond to a diffuse field absorption coefficient since there is certainly not an equal probability of the energy, directly from the source, arriving from all possible directions.

Conservation of energy requires that:

$$\left[\begin{array}{l} \text{Rate of increase} \\ \text{of reverberant} \\ \text{energy in room} \end{array} \right] = \left[\begin{array}{l} \text{Rate of emission of} \\ \text{energy from source} \\ \text{into reverberant field} \end{array} \right] - \left[\begin{array}{l} \text{Rate of absorption} \\ \text{of reverberant} \\ \text{energy} \end{array} \right]$$

In the spirit of the assumption of a uniform diffuse reverberant sound field, the rate of absorption of reverberant energy at any given instant of time should be proportional to the sound energy density in the room at that instant. The total energy in the reverberant sound field is VD_R , where V is the volume (m^3) of the room and D_R is the energy density in the reverberant sound field (Jm^{-3}). Thus the differential equation which follows from the above statement of energy conservation is

$$V \frac{dD_R}{dt} = (1 - \alpha_0)W - \frac{2VD_R}{\tau} \quad (10)$$

where τ is a characteristic time which defines the rate of sound absorption in the room, whether by the walls, the air in the room, or by other surfaces such as diffusers. Under steady-state conditions ($dD_R/dt = 0$), the energy density is given by

$$D_R = \frac{\tau(1 - \alpha_0)W}{2V} \quad (11)$$

The energy density in a diffuse sound field can be shown to be equal to $p^2/\rho c^2$, where p^2 is the mean-square sound pressure (Pa^2) and ρ is the density of air ($kg m^{-3}$) in the room; thus

$$\overline{p_R^2} = \frac{\rho c^2 \tau (1 - \alpha_0) W}{2V} \quad (12)$$

is the mean-square sound pressure in the reverberant field only.

If the reverberant sound energy density is assumed to have a constant value, and, at time $t = 0$ the sound power input is suddenly turned off, the energy density will decay as

$$\frac{1}{D_R} \frac{dD_R}{dt} = - \frac{2}{\tau} \quad (13)$$

so that τ also is seen to be the time constant which defines the rate of decay of the reverberant sound field; alternatively

$$\frac{d(\ln \overline{p_R^2})}{dt} = - \frac{2}{\tau} \quad (14)$$

where " \ln " designates the natural logarithm (to the base $e = 2.71828\dots$), indicating that τ can be directly obtained by measuring the rate of decay of the sound pressure level when the source of sound power is turned off.

Converting to sound pressure level, $L_{p_R} = 10 \log (p_R^2/p_0^2)$, where $p_0 = 20$ micropascals (μPa) is the reference pressure, and sound power level, $L_W = 10 \log (W/W_0)$, where $W_0 = 1$ picowatt (pW) is the reference power, eq. (12) becomes

$$L_{p_R} = L_W + 10 \log \left[\frac{\tau(1 - \alpha_0)}{2V} \right] + 10 \log \left(\frac{\rho c^2}{400} \right) \text{ dB.} \quad (15)$$

The time constant, τ , is related to the commonly used reverberation time, T -- the time required for the sound field to decay by 60 dB -- by the relation $T = 6.91\tau$, the non-integer number arising from the conversion between natural and common logarithms. The last term in eq. (15) can be evaluated by recalling that for an ideal gas, $\rho c^2 = \gamma B$, where γ is the ratio of specific heats (≈ 1.4 for air) and B is barometric pressure (Pa). Utilizing these quantities, eq. (15) can also be written as

$$L_{p_R} = L_W + 10 \log \left[\frac{T(1 - \alpha_0)}{V} \right] + 10 \log B - 36.0 \text{ dB.} \quad (16)$$

Equation (16) is analogous to the corresponding expressions in the current international[10] and national[29] standards for determination of sound power in reverberation rooms, with the following differences:

- the constant term differs because the barometric pressure in the standards is expressed in millibars (1 bar = 10^5 Pa);
- there is an additional term in the standards arising from interference effects near the room boundaries; the above derivation neglects such effects;
- the standards do not include the term $10 \log (1 - \alpha_0)$; this will be discussed shortly.

In order to ensure that the sound field "sees" the same effective absorption in both the steady-state power determination and the transient decay rate for reverberation time measurement, the sound source used to excite the room for reverberation time measurements preferably should be in the same location and have the same directivity as the source whose sound power is being determined.

An alternative method of measuring the effective room absorption is by use of a reference sound source of known sound power output. This known source should be at the same location as the unknown source and preferably have a similar directivity. Looking at eq. (16) for tests on two sources under otherwise identical conditions,

$$(L_{p_R})_1 - (L_{p_R})_2 = (L_W)_1 - (L_W)_2, \quad (17)$$

so that no explicit knowledge of room properties is required.

These expressions are based upon measurements of the mean-squared sound pressure of the reverberant field. Thus it is necessary to examine the relative strengths of the direct and reverberant fields to determine where microphones may be located. The mean-square sound pressure due to the direct field may be expressed as

$$\overline{p_D^2} = \rho c \frac{WQ_0}{4\pi r^2} \quad (18)$$

where the directivity factor Q_0 is defined as the ratio of (1) the mean-square sound pressure measured at angle θ and distance r from an actual source radiating a power W to (2) the mean-square sound pressure measured at the same distance from a nondirective (spherical) source radiating the same total acoustic power W .

The total mean-square pressure due to both the direct and the reverberant field follows from eqs. (12) and (18):

$$\overline{p_T^2} = \overline{p_D^2} + \overline{p_R^2} = \rho c \cdot W \left[\frac{Q_0}{4\pi r^2} + \frac{\tau(1 - \alpha_0)c}{2V} \right] \quad (19)$$

The difference between the total sound pressure level and the reverberant field sound pressure level is

$$L_{p_T} - L_{p_R} = 10 \log \left[1 + \frac{Q_0}{4\pi r^2 c} \cdot \frac{2V}{\tau(1 - \alpha_0)} \right] \quad (20)$$

Substituting $T = 6.91\tau$ and $c = 343.4$ m/s (air at 20° C),

$$L_{p_T} - L_{p_R} = 10 \log \left[1 + 0.0032 \frac{V}{T(1 - \alpha_0)} \frac{Q_0}{r^2} \right] \quad (21)$$

The difference, $L_{p_T} - L_{p_R}$, between the total sound level and the reverberant field level is plotted vs $r/Q_0^{1/2}$, the equivalent distance from the acoustic center of the source, in Figure 8 with $V/[T(1-\alpha_0)]$ as a parameter. It can be seen that as V/T becomes large, it is necessary to be much farther from the source in order for the direct field contribution to the sound field to become negligible. While it is rather obvious that, for a chamber of a given volume, the direct field contribution decreases as the reverberation time increases, it is perhaps less evident that for a given reverberation time, it is necessary to be farther from the source in a large chamber than it is in a small chamber.

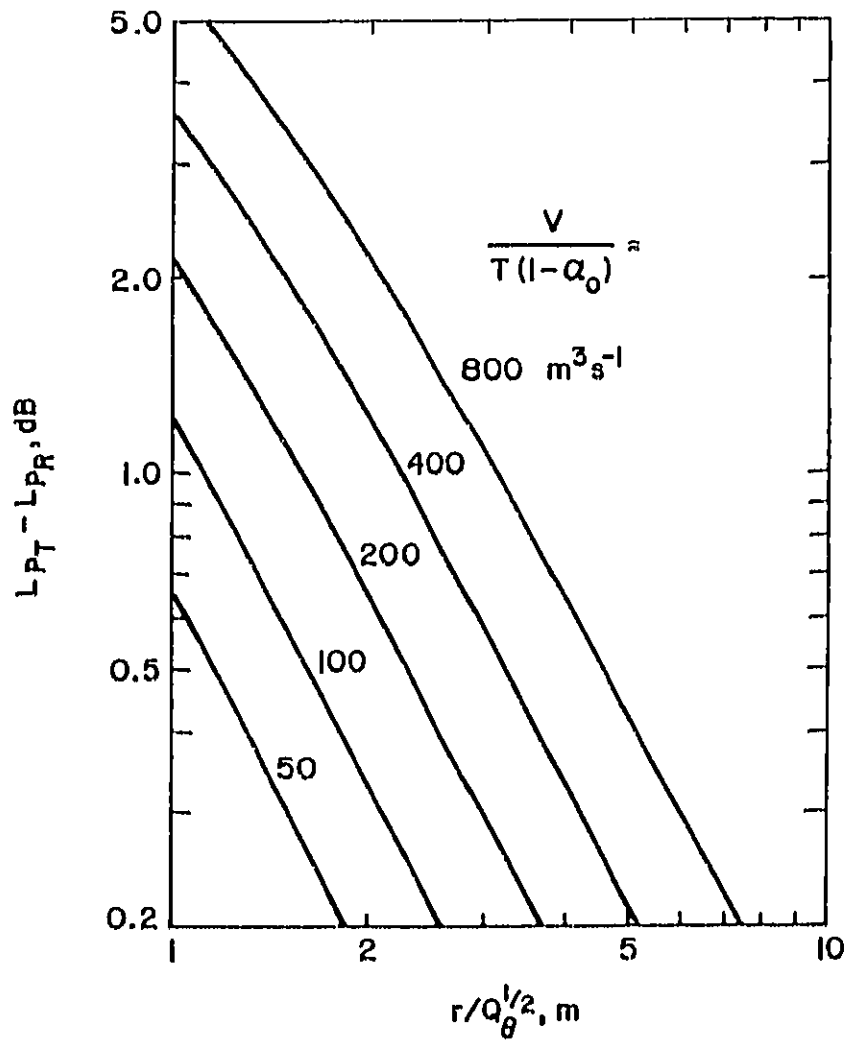

Figure 8. Difference between the total sound level and that due to the reverberant field alone, shown versus the effective distance from the source.

REST AVIAN ABI E COPY

Equation (21) and Figure 8 provide information as to the criteria which a reverberation chamber should meet in order to have a negligible contribution from the direct field at reasonable distances from the source. The key points are

T/V should be as large as possible; this is equivalent to the total absorption in the room being as small as possible;

highly directive sources require that measurements in the direction(s) of maximum noise emission be taken at distances from the source which are larger than when $Q=1$.

There is still another reason to require the sound absorption in the room to be very small. Returning to eq. (16), the term $10 \log (1 - \alpha_0)$ is normally neglected in computing sound power from mean-square sound pressure levels in the reverberant field. As discussed at the beginning of this section, the particular value of α_0 may depend on the location and directivity of the noise source and, in general, cannot be measured directly in any simple manner. Figure 9 shows $-10 \log (1 - \alpha_0)$ plotted vs α_0 ; it is seen to become a significant correction when α_0 exceeds a value of about 0.1. An approximate value for α_0 can be computed from the reverberation time and room geometry but the percentage uncertainty in the value so obtained could be fairly large.

The above discussion does not address wave effects. When consideration is also given to wave effects, further guidance on room size, shape, and absorption can be obtained. The frequency of a normal mode of vibration (so-called "resonance frequency") in a rectangular room with hard boundaries is given by

$$f = \frac{m}{2n} = \frac{c}{2} \left[\left(\frac{n_x}{l_x} \right)^2 + \left(\frac{n_y}{l_y} \right)^2 + \left(\frac{n_z}{l_z} \right)^2 \right]^{1/2} \quad (22)$$

where n_x , n_y , and n_z are integers and l_x , l_y , and l_z are, respectively, the length, width, and height of the room. It can be shown that as f increases the number of normal modes in a frequency band of width Δf centered on f approaches the value

$$\Delta N \approx \left[\frac{4\pi V}{3c^3} f^2 + \frac{\pi S}{2c^2} f + \frac{L}{8c} \right] \Delta f, \quad (23)$$

where V is the volume of the room, S is the total surface area of the walls, and L is the sum of the lengths of all edges of the room. For frequency analysis in 1/3-octave or 1/1-octave bands, eq. (23) may be written as

$$(\Delta N)_{1/3} \approx \frac{2.91V}{c^3} f_c^3 + \frac{0.36S}{c^2} f_c^2 + \frac{0.03L}{c} f_c \quad (24a)$$

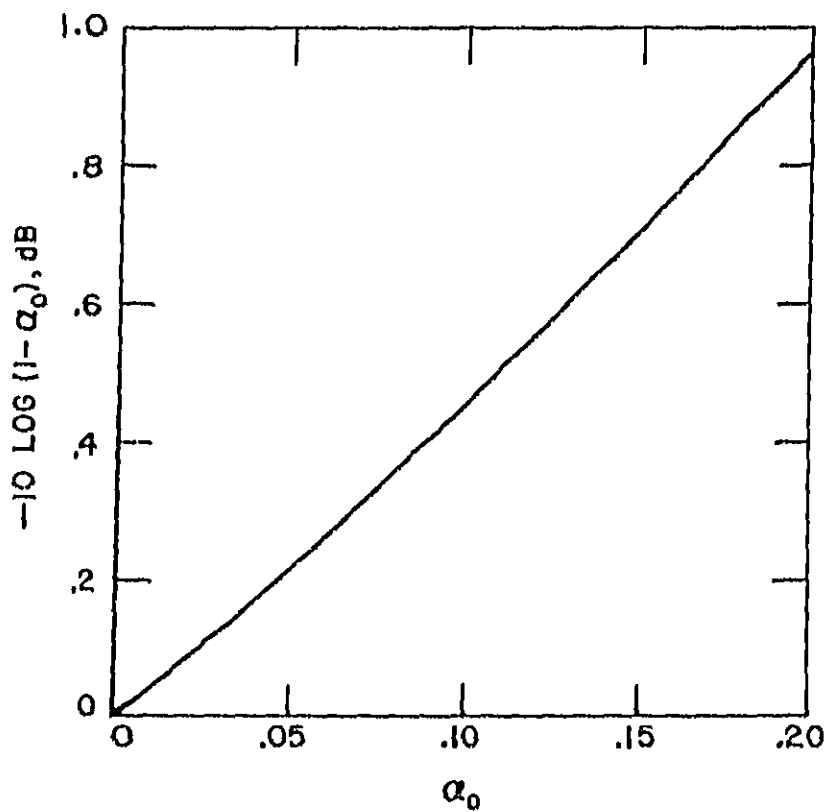

Figure 9. The effect of neglecting the $10 \log (1-\alpha_0)$ term in eq. (16).

and

$$(\Delta N)_{1/1} \approx \frac{8.89V}{c^3} f_c^3 + \frac{1.11S}{c^2} f_c^2 + \frac{0.091}{c} f_c \quad (24b)$$

where f is the band center frequency. For a given room volume, these equations predict that a cubical room will have the lowest modal density of any basically rectilinear room shape. Figure 10 shows the approximate number of modes in 1/3-octave frequency bands, as a function of frequency, for cubical rooms 4, 6, 8 and 10 m on a side. There would be approximately three times as many modes in an octave band having the same center frequency.

A knowledge of the characteristic frequencies of a reverberation room is important in terms of understanding its properties as a measurement tool. If excited at a location where there is not a node in the pressure standing wave pattern, a room will act as a resonator and may respond strongly to impressed sound energy at frequencies near to the characteristic normal mode frequencies. The extent to which the room responds is dependent upon the reverberation time. In electrical circuit theory it is customary to talk about the "Q" of a circuit element and in microwave theory, the "Q" of a cavity. In the same sense it is useful to consider the Q of a reverberation room. Q is defined as

$$Q = \pi f_o \tau = \frac{f_o T}{2.20} \quad (25)$$

where f_o is a natural frequency of the room and $T \approx 6.91\tau$ is the reverberation time. The frequency response of the mean-square sound pressure, for large Q, is given approximately by

$$\overline{p^2}(f) \propto \frac{f^2/f_o^4}{(f^2/f_o^2 - 1)^2 + 1/Q^2} \quad (26)$$

Substituting eq. (25) into eq. (26),

$$\overline{p^2}(f) \propto \frac{f^2/f_o^4}{(f^2/f_o^2 - 1)^2 + 1/(\pi f_o \tau)^2} = \frac{f^2/f_o^4}{(f^2/f_o^2 - 1)^2 + (2.20/f_o T)^2} \quad (27)$$

It can be seen that if T is very large, the room will have a highly peaked response for frequencies near f_o while for small T the response peak will be shorter and broader.

To provide an example of the significance of the height and width of the resonant peaks, consider a room in which, for the 1/3-octave band centered at

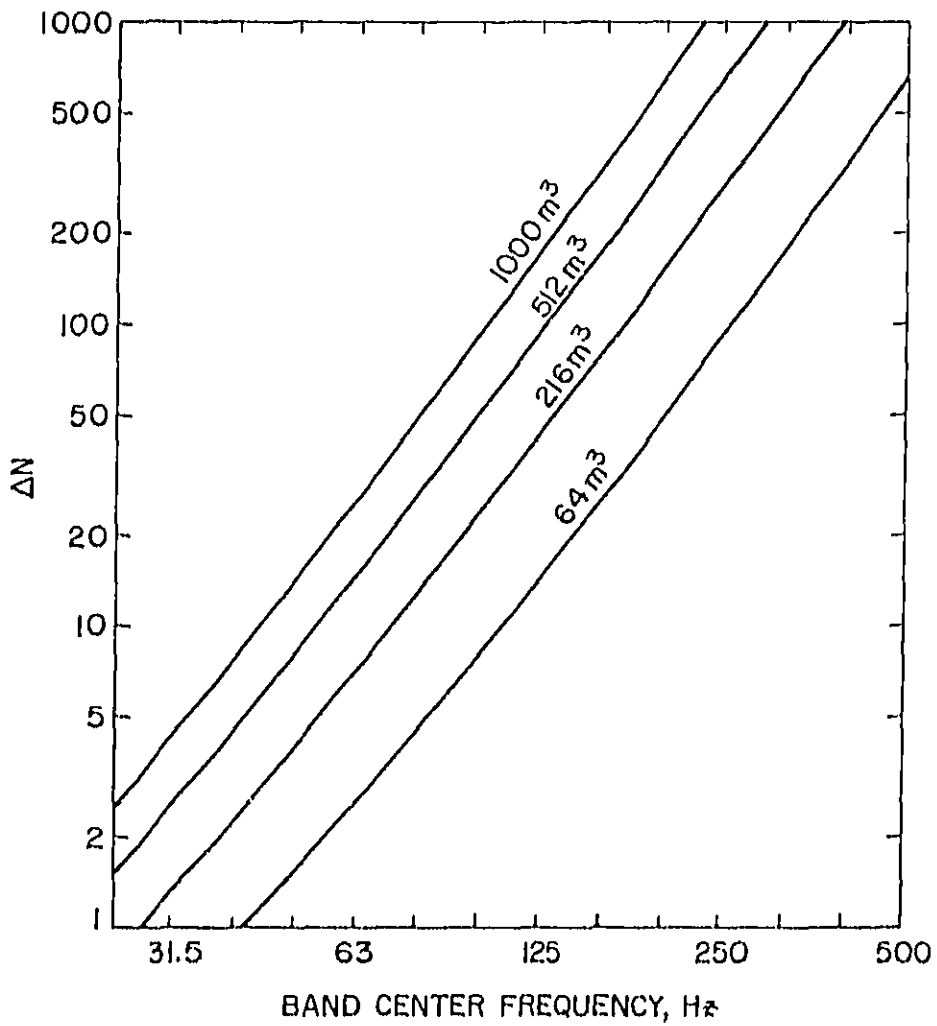

Figure 10. Approximate number of normal modes in a 1/3-octave frequency band for cubical rooms of the volume shown.

BEST AVAILABLE COPY

100 Hz, there are only three normal modes, at frequencies of 95, 100, and 105 Hz, respectively. It is further assumed that these modes all have the same reverberation time (see discussion below). Figure 11 shows the frequency response of the room, when all three modes are of equal "strength", for reverberation times of 1 and 20 seconds. It is seen that when T is large the average sound pressure level in the room varies rapidly with frequency. Figure 12 illustrates how the "range" of this variation, defined as shown in Figure 11, varies with the reverberation time of the room for different spacings of the normal mode frequencies. In Figure 12, it has been assumed that there are a number of modes of equal "strength" spaced uniformly, at a separation of $\delta f = 1, 2, 3, 4, \text{ or } 5$ Hz, within a frequency band centered at 100 Hz. (Alternatively, the modal spacing can be thought of as being 1, 2, 3, 4, or 5 percent of any band center frequency.) Note that both T and δf depend upon the room volume.

If a noise source were to emit only a pure tone at some frequency in the band pass region of the filter, the resultant mean-square sound pressure in the room would be dependent upon how close the driving frequency is to one or more resonant frequencies. In order for the room to be relatively insensitive to such an effect, it would be desirable to have a large number of modes in the measurement bandwidth, to have those modes as uniformly spaced as possible, and to have the resonance peaks broad enough to "fill in the gaps" between adjacent peaks. The implications of these observations are:

- the room should be large to increase the number of modes in a given frequency interval,
- the geometry of the room should be selected to maximize the number of modes and promote uniformity of spacing,
- the reverberation time should be low enough to broaden the resonance peaks by an amount comparable to the modal spacing.

Summarizing, the number of modes is controlled by the size of the room, while the modal spacing is controlled by the shape of the room. If the room is very hard (i.e., long reverberation time corresponding to low absorption) the resonance peaks will be sharp -- at lower frequencies where the modal density is low and the modal spacing may not be uniform, the room response, as a function of frequency, may not be as uniform as desired. Thus it is desirable to add low frequency absorption to enhance modal overlap. However, additional absorption will decrease the spatial volume in which the reverberant sound field is well above the direct field from the source. A compromise should be sought between these two effects.

Inspection of eq. (22) shows that a phenomenon, known as degeneracy, in which the same resonance frequencies occur more than once, will be exhibited any time the dimensions of the room are in the ratio of small integers. Among

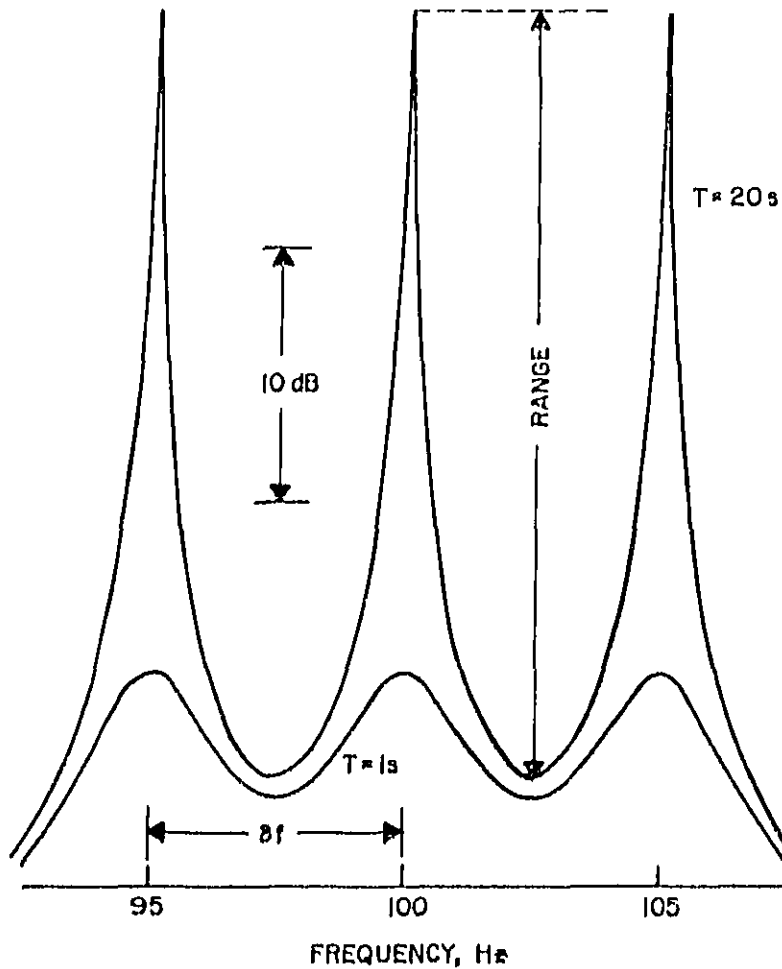

Figure 11. Frequency response of a reverberation room having equal-strength modes at 95, 100, and 105 Hz for reverberation times of 1 and 20 s, respectively.

RECT AVIAR AM E POCO

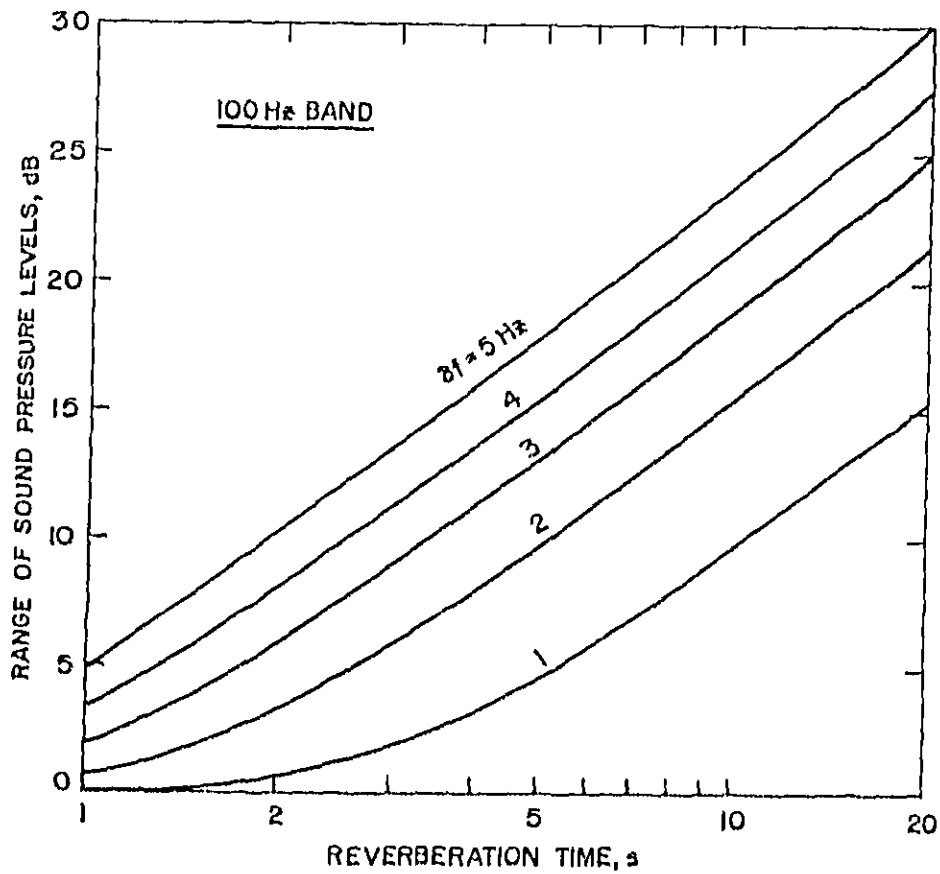

Figure 12. Range of the variation (peak-to-valley in Figure 11) in the frequency response of a reverberation room for frequencies near 100 Hz as a function of reverberation time for different modal spacings.

rectangular rooms, a cubical shape exhibits the largest number of degenerate modes and hence clearly should be avoided. Current international[10] and national[29] standards list the following room proportions as having been found to give satisfactory mode spacing for rooms of about 200 m³ volume (the "preferred minimum room volume" for measurements down to the 1/3-octave band centered at 100 Hz):

l_y/l_x	l_z/l_x
0.83	0.47
0.83	0.65
0.79	0.63
0.68	0.42
0.70	0.59

The width of a resonance line shape can be characterized by the width of the peak (see Figure 13) between the frequencies at which the energy density is one-half of what it is at the exact resonance frequency. This width, given by

$$\Delta f = f_0/Q = 1/\pi T = 2.20/T \quad (28)$$

defines the frequency region in which the mean-square pressure is within 3 dB of that at the resonance frequency. It would seem reasonable to select the room's reverberation time such that the width of a resonance line is significantly greater than the average spacing between normal modes for the lowest frequency of interest (i.e., modal overlap, $M = \Delta f/\delta f$, significantly greater than unity); thus, from eq. (23), one would desire

$$\frac{\pi}{2.20} \leq \frac{1}{M} \cdot \frac{4\pi V}{c^3} f^2, \quad (29)$$

where M is the desired amount of modal overlap and only the most significant term in eq. (23) has been retained. With $c = 343.4 \text{ m s}^{-1}$ (air at 20°C) and V expressed in cubic meters, this becomes

$$T \leq 0.68 \frac{V}{M} \left(\frac{f}{1000} \right)^2. \quad (30)$$

If one selects $M = 3$, the lowest frequency at which a reverberation room could be used and still meet the selected criterion for modal overlap would be

$$f \geq 2100 \left(\frac{\pi}{V} \right)^{1/2}. \quad (31)$$

All of the analyses in this sub-section are rather approximate. For more rigorous treatments of room acoustics, see[30-36].

REF ID: A61111

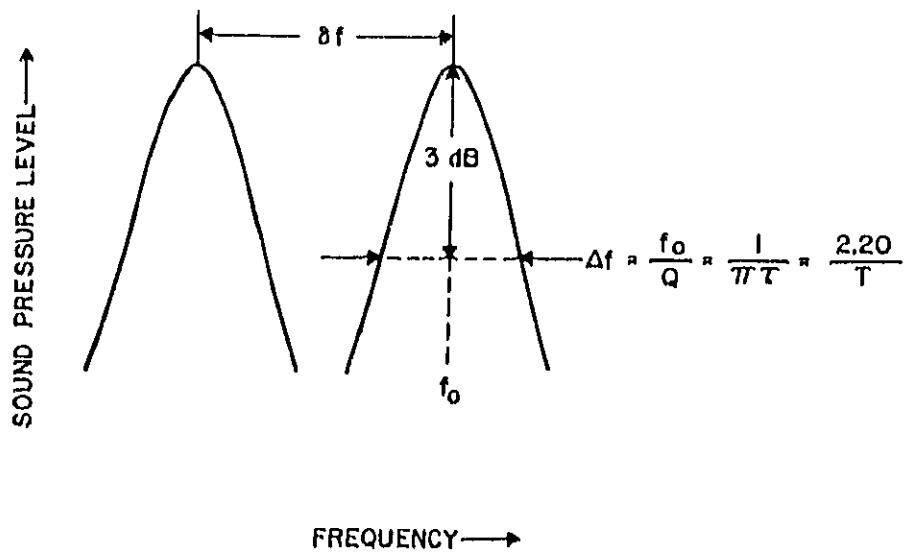

Figure 13. Drawing illustrating the spacing, δf , between normal modes, the width, Δf , of a normal mode, and the relationships among Δf , f_0/Q , τ , and T .

As discussed earlier, it is desirable to make the reverberation time as large as possible so that the uncertainty due to inadequate knowledge of α is acceptable and, over most of the room volume, the contribution from the direct field is negligible compared to the reverberant field. At lower frequencies, these desiderata are in conflict with the just-discussed criterion calling for a reverberation time small enough to spread the resonance peaks in the room response. For any given room it is desirable to analyze all of these factors and select an adequate compromise for the situation at hand.

The current American standard[29] requires that the room volume be "at least 180 m³ and preferably 200 m³ for measurements including the 125 Hz octave band, and 70 m³ for measurements covering the 250 Hz and higher octave bands, but excluding the 125 Hz band." It further states that

"the floor of the test room shall be reflective with an absorption coefficient below 0.06. Apart from the floor, none of the surface should have absorptive properties significantly deviating from those of the other surfaces. For each one-third octave band within the frequency range of interest the mean value of the absorption coefficient of each wall and of the ceiling should thus be within 0.5 and 1.5 times the mean value of the absorption coefficient of all walls and ceiling."

The following guidelines are given with regard to the absorption of the room:

"The sound absorption coefficients of the surfaces of the reverberant room must be small enough to insure an adequate reverberant field. The coefficient must be large enough to minimize the effect of source position on the sound power produced by the source (refer to the qualification procedure of Section 11). The average sound absorption coefficient of all surfaces of the reverberation room should not exceed 0.06 over the frequency range of interest, except that additional absorption below a frequency given by

$$f = \frac{2000}{\sqrt{V/3}}$$

is usually desirable in order to increase the bandwidth of the resonance curves of the normal modes of the room. The highest value of the average sound absorption coefficient, at any frequency, should not exceed 0.16."

The international standard[10] includes very similar requirements.

Both the American and international standards[10, 11, 29] include quite detailed room qualification procedures -- separately for the measurement of broad band sound and for the measurement of discrete frequency components. These procedures involve not only the reverberation chamber but source locations, microphone locations, diffusing elements, and, in effect, the entire measurement procedure. Anyone planning to conduct reverberation room measurements should study these standards carefully.

In the present section, the relations among room absorption, source location, and power output have not been discussed. These will be covered in Section 15.3.

d. In Situ

It is not possible even to attempt to cover all of the different types of test environments that might be encountered in carrying out in situ tests. In general, measurements should be made to determine the extent to which the test environment approaches an anechoic, semi-anechoic or reverberant environment. The types of measurements which should be made should be fairly obvious from the preceding discussions.

Whenever the sound source can be removed from the test environment, the environmental influence should be checked by placing a reference sound source at selected points which define the boundaries where the actual source will be and then measuring the sound pressure at various distances from each reference source location. Procedures for correcting sound power measurements for the influence of the test environment are discussed in Section 16.2.

12.3. Criteria for Background Noise

In some locations, particularly for in situ measurements, it may not be possible to maintain background noise sufficiently below the noise emitted from the source for the background noise to be neglected. In that case, the measured values at each microphone location may be adjusted using the corrections given in Table 3.

These corrections are predicated upon the background noise not being coherent with the noise emitted from the source. As an example of a case where this might not be true, the noise from a ventilating fan which emits discrete frequency components could have a definite phase relation to the noise from the test source when both are connected to the 60 Hz line power. Then the above corrections for background noise would be inappropriate.

In some circumstances, it may be difficult to separate the noise of a particular piece of equipment from the noise of its supporting equipment. For example, in measuring the noise of a pneumatic tool, care has to be taken to ensure that the noise from the air compressor is not influencing the results. Background noise measurements made with the tool inactive and the compressor operating might not be appropriate since the noise from the compressor may increase when it is called upon to supply air for the tool.

Another problem area is time-varying background noise. Consider an outdoor test site fairly near a highway. Background noise measurements have little meaning unless one can be confident that the average background noise was the same during the time interval when the noise emitted from the source was measured.

Table 3 Corrections for Background Sound Pressure Levels

Difference (in decibels) between sound pressure level measured with sound source operating and background sound pressure level alone	Correction (in decibels) to be subtracted from sound pressure level measured with sound source operating to obtain sound pressure level due to sound source alone
6	1.3
7	1.0
8	0.8
9	0.6
10	0.4
11	0.3
12	0.3
13	0.2
14	0.2
15	0.1

12.4. Criteria for Temperature, Barometric Pressure, Humidity, and Wind

a. Temperature

A measurement standard should include restrictions on the allowable temperature range over which measurements may be conducted and, if practical, provide corrections for the effects of temperature. Temperature can affect the measurement results in the following ways:

- the performance of the test source may be a function of temperature with the result that the noise emitted varies with temperature even though the operating load appears to be constant;
- the properties of the air surrounding the test source may vary sufficiently with temperature to affect the sound pressure at the measurement locations;
- temperature gradients or inhomogeneities in the atmosphere cause refraction or scattering of the sound;
- the accuracy of the measuring instrumentation may be affected by temperature.

The acoustic impedance of air is affected by both temperature and by barometric pressure and will be discussed in the section on barometric pressure. Absorption of sound by the air is influenced by temperature, barometric pressure, and humidity; it will be discussed in the section on humidity.

In making measurements outdoors over a reflecting plane, errors can occur due to refraction of sound arising from the variation of the speed of sound due to a steep temperature gradient above the reflecting plane. Such an effect would be expected to be particularly serious for sources which emit pure tones and to be worse at higher frequencies where the wave length of the sound is much shorter than the height of the source and/or the measuring microphone above the reflecting plane. To a certain extent this could be compensated for by multiple microphone locations or by traversing the microphone over an appropriate path (see Sec. 15.2).

It is difficult to generalize on the effects of temperature on measuring instrumentation. The American standard for sound level meters[37] includes the following statement:

"7.1 Temperature. The temperature range over which the sensitivity of the sound level meter varies less than 0.5 decibel at any frequency shall be stated by the manufacturer. If this range does not include the extremes of -10° to 50° C, the manufacturer shall supply temperature correction values over that range. If provision for internal

calibration is made in the sound level meter, the manufacturer shall state the effect, if any, of temperature upon the calibration system, and thence upon the self-calibrated sound level meter over the temperature range of -10° to 50° C. The manufacturer shall state the temperature limits beyond which permanent damage to the sound level meter may occur."

If it is intended to make measurements over a broad temperature range, the instrumentation system should be calibrated over that range -- care should be taken that the calibration procedure itself does not have unaccounted-for temperature effects.

b. Barometric Pressure

In Section 12.2, it was indicated (see eq. (12)) that in a reverberation chamber, the mean-square sound pressure is proportional to $\rho c^2 W$. A similar analysis of free-field radiation would show that the mean-square sound pressure is proportional to $\rho c W$. Thus the computation of sound power requires inclusion of a term of the form $10 \log (\rho c^2)$ for reverberation room sound power level* and a term of the form $10 \log (\rho c)$ for free field sound power level. These terms do not correct the data to correspond to standard conditions of temperature and barometric pressure, but are simply part of the procedure to calculate sound power level from sound pressure level data (or vice versa).

The effect of a variation in temperature and pressure on reverberation room measurements is more readily seen by rewriting eq. (15) as

$$L_W = L_{PR} - 10 \log \left[\frac{\tau(1 - \alpha)}{2V} \right] - 10 \log \left[\frac{\rho_o c_o^2}{400} \right] - 10 \log \left[\frac{\rho c^2}{\rho_o c_o^2} \right]; \quad (32)$$

thus if the calculation were made using a standard value, $\rho_o c_o^2$, the correction term to be subtracted is $10 \log (\rho c^2 / \rho_o c_o^2)$.

For free field measurements over an imaginary sphere at radius r from a point source of power W , the mean-square sound pressure is

$$\overline{p^2} = \frac{\rho c W}{4\pi r^2}, \quad (33)$$

from which the equation for power level is seen to be

$$L_W = L_p + 10 \log(4\pi r^2) - 10 \log \left[\frac{\rho_o c_o}{400} \right] - 10 \log \left[\frac{\rho c}{\rho_o c_o} \right]. \quad (34)$$

*If reverberation room calculations are made using total room absorption, A , rather than reverberation time, T , to account for the power loss at the boundaries and in the air, the term τ/V is replaced by cA/h , the c cancels one of the c 's in ρc^2 and the correction term becomes $10 \log_{10} (\rho c)$ -- the same as for free-field radiation.

The dependence of $10 \log (\rho c / \rho_0 c_0)$ on temperature and barometric pressure is shown in Figure 14. The curve corresponding to 0°C also represents the dependence of $10 \log (\rho c^2 / \rho_0 c_0^2)$ on pressure since ρc^2 is independent of temperature. These dependencies stem from the following equations, based on the ideal gas law:

$$\rho c = \rho_0 c_0 \frac{h}{h_0} \left(\frac{T_0}{T} \right)^{1/2} \quad (35)$$

where $\rho_0 c_0$ is the value of the acoustic resistance at barometric pressure B_0 and absolute temperature T_0 , and

$$\rho c^2 = \rho_0 c_0^2 \frac{h}{h_0} \quad (36)$$

As stated previously, the above discussion only concerns the influence of temperature and barometric pressure on the calculation of sound power level from the appropriate sound pressure level. It does not correct the results of a calculation to correspond to the noise emission of a source under some standard conditions other than those which existed at the time of measurement. Temperature and barometric pressure directly influence both the radiated sound power and the sound pressure at a particular location, but in a manner that is different for different types of sources. Sources with very high internal acoustic impedance (constant velocity sources) will be affected differently from sources having very low internal impedance (constant near-field pressure).^{*} In addition, sources having different directionality characteristics are affected differently by temperature and barometric pressure. Expressions for monopole, dipole, and quadrupole point sources, radiating into a free field (air) have been derived from equations in Morse and Ingard[32, pp 306-318] and are listed in Table 4 for sound sources having either constant velocity or constant near-field pressure. It can be seen that the dependence on temperature and the dependence on barometric pressure can be quite different for different types of sources. Thus corrections to standard conditions cannot be made reliably without some knowledge of the characteristics of the noise source.

A related phenomenon that also can affect the accuracy of acoustical measurements is the dependence of sound pressure level produced by piston-phones, and other types of microphone calibrators, on barometric pressure.

^{*}See Section 15.1 for discussion of particle velocity, volume velocity, near field, and far field.

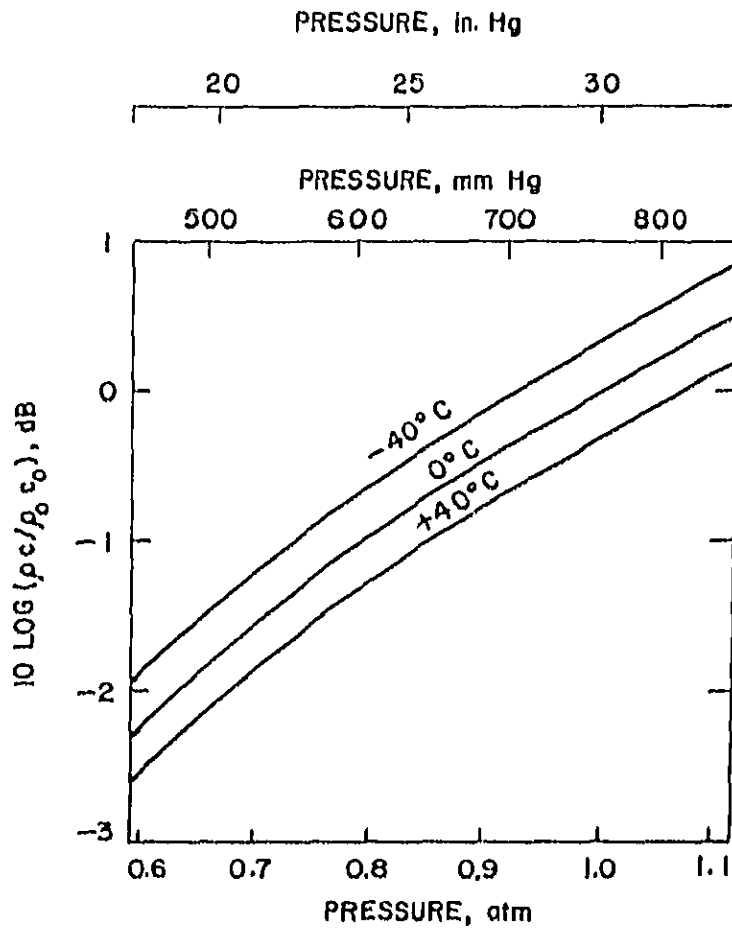

Figure 14. Pressure dependence of the acoustic resistance of air.

DEPT. OF THE ARMY, WASH. D. C.

Table 4. Dependence of far-field sound pressure and radiated sound power on barometric pressure and temperature for various types of sound sources. The numbers in parentheses represent the rates of change for the source in air at 760 mm Hg (1.013×10^5 Pa) and 20°C (293.15 K).

Type of Source	Constant Volume Velocity		Constant Near-Field Pressure	
	mean-square pressure	sound power	mean-square pressure	sound power
Monopole	$\left(\frac{B}{B_0}\right)^2 \left(\frac{T}{T_0}\right)^{-2}$ (.011 dB/mm Hg) (-.030 dB/°C)	$\frac{B}{B_0} \left(\frac{T}{T_0}\right)^{-3/2}$ (.006 dB/mm Hg) (-.022 dB/°C)	1 (0 dB/mm Hg) (0 dB/°C)	$\left(\frac{B}{B_0}\right)^{-1} \left(\frac{T}{T_0}\right)^{1/2}$ (-.006 dB/mm Hg) (.007 dB/°C)
Dipole	$\left(\frac{B}{B_0}\right)^2 \left(\frac{T}{T_0}\right)^{-3}$ (.011 dB/mm Hg) (-.044 dB/°C)	$\frac{B}{B_0} \left(\frac{T}{T_0}\right)^{-5/2}$ (.006 dB/mm Hg) (-.037 dB/°C)	$\left(\frac{T}{T_0}\right)^{-1}$ (0 dB/mm Hg) (-.015 dB/°C)	$\left(\frac{B}{B_0}\right)^{-1} \left(\frac{T}{T_0}\right)^{-1/2}$ (-.006 dB/mm Hg) (-.007 dB/°C)
Quadrupole	$\left(\frac{B}{B_0}\right)^2 \left(\frac{T}{T_0}\right)^{-4}$ (.011 dB/mm Hg) (-.059 dB/°C)	$\frac{B}{B_0} \left(\frac{T}{T_0}\right)^{-7/2}$ (.006 dB/mm Hg) (-.052 dB/°C)	$\left(\frac{T}{T_0}\right)^{-2}$ (0 dB/mm Hg) (-.030 dB/°C)	$\left(\frac{B}{B_0}\right)^{-1} \left(\frac{T}{T_0}\right)^{-3/2}$ (-.006 dB/mm Hg) (-.022 dB/°C)

7L

REF ID: A61111

c. Humidity

The two major effects of humidity on noise measurements are (1) the effect on absorption on sound by the air and (2) effects on measurement systems.

Sound energy is attenuated by molecular absorption, by viscosity, and by heat conduction. For a plane wave, the mean-square sound pressure will attenuate with distance as

$$\overline{p^2}(x) = \overline{p^2}(0)\exp(-mx), \quad (37)$$

where $\overline{p^2}(0)$ is the mean-square pressure at $x = 0$. Converting to sound pressure level,

$$L = L(0) - Mx, \quad (38)$$

where $M = 4.343m$ is the attenuation in decibels/meter. The attenuation coefficient varies in a complicated manner with temperature, humidity, and barometric pressure. It is larger at high frequencies and, at normal temperatures, peaks at rather low relative humidities. Representative curves are given in Figure 15. For additional information see [38, 39] and the references therein.

The effect of air absorption is quite important, especially at higher frequencies, in reverberation room measurements since, with hard walls, the reverberation time is severely limited by absorption of sound by the air. This requires that care be taken to measure reverberation times under the same atmospheric conditions as when steady-state sound energy density measurements are made. Current national [29] and international [10] standards require that the temperature t ($^{\circ}\text{C}$) and the relative humidity rh (percent) be controlled such that the product $rh(t+5)$ does not differ by more than ± 10 percent from the value of this product which prevailed during the measurements of the reverberation time (for the direct method) or reference sound sources (for the comparison method).

Even when carefully controlled, high air absorption at high frequencies, coupled with the fact that sound sources tend to be more directive in their radiation pattern at high frequencies, can make it difficult to achieve a diffuse reverberant field that is sufficiently larger than the direct field from the source.

A major effect of high humidity on acoustical measurement systems is condensation of moisture in microphones, resulting, in the case of condenser microphones, in electrical leakage. Many condenser microphones are heated to avoid this problem. High humidity can also lead to electrical leakage in

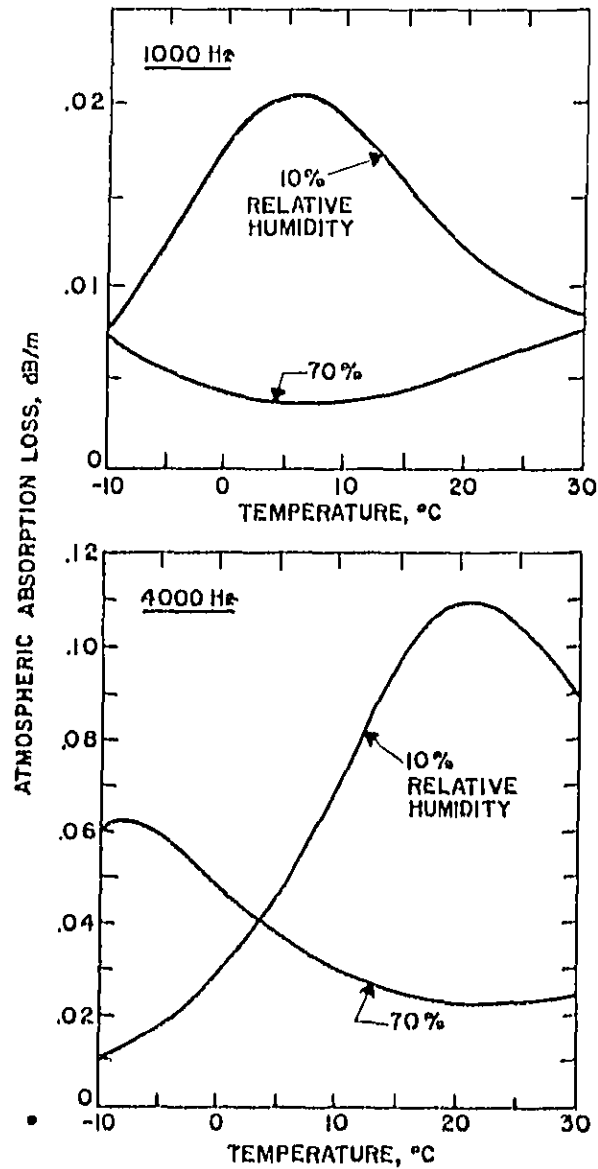

Figure 15. Atmospheric absorption loss in air as a function of temperature for relative humidities of 10 and 70 percent at frequencies of 1000 and 4000 Hz.

REF ID: A61118

cables, connectors, or instruments.

d. Wind

A serious effect of wind on outdoor measurements is the extraneous noise generated by the wind blowing across the microphones. In general, a wind screen should always be used and a measurement standard should set limits, analogous to those for background noise, on the allowable wind noise[35].

Wind can also influence the propagation of noise from the source. A shadow zone, into which no direct sound can penetrate, may be encountered upwind from a source because the typical positive wind gradient (i.e., wind speed increasing with height above the ground) bends the sound rays upward[33,35]. If measurements must be made a considerable distance from the source, tighter limits (than for close-in measurements) should be placed on allowable wind speeds.

12.5. Criteria for Size of the Test Equipment

A given test facility should be sufficiently larger than the equipment being tested to enable measurements to be made outside of the near field of the noise source. The International Organization for Standardization draft on laboratory measurements in anechoic and hemi-anechoic chambers[14] recommends that the volume of the source be less than 0.5 percent of the volume of the test room (e.g., a 1 m³ source may be tested in a 200 m³ chamber). For large equipment, such a restriction would be too severe for practicality. However, the measurement standard should adequately address this point.

12.6. Criteria for Reflecting Surfaces

A discussion was given in Section 12.2, in conjunction with the material on measurements in a hemi-anechoic space, of the importance of the reflecting plane having a very low sound absorption. This can be particularly difficult in outdoor measurements on large, or mobile, sources where it may be difficult to find large paved areas with sufficiently low sound absorption. In general, measurements over grass or soil are not recommended -- the surface is neither hard enough to approximate a perfect reflector nor soft enough to approximate a perfect absorber.

Even when the source of the noise is very close to the ground, so that there are essentially no reflections, difficulties may arise. A sound wave traveling parallel to an absorptive surface can lose energy into that surface if the "sound rays" pass close, in terms of wavelength, to the surface.

In addition to criteria for the reflecting plane, measurement standards should include restrictions on the presence of nearby objects which could reflect sound energy in such a way as to influence the test results.

13. Instrumentation for Noise Measurements

- The measurement standard should require that each instrument meet specified requirements of existing national or international standards. For instruments for which standards do not exist or where existing standards are not sufficient, the measurement standard should include specific criteria for evaluating the performance of such devices, e.g., for sources which produce transient signals the standard might include allowable tolerances for system response to one or more well-defined transient events.
- The measurement standard should clearly state the allowable tolerances for frequency response, environmental effects, harmonic distortion, etc., which the instruments are required to meet. These specifications should be applied not only to specific components of the system but to the overall system as well.
- The measurement standard should require overall system calibration at stipulated intervals. The fact that each component of the system appears satisfactory does not ensure that the system performance will be acceptable.
- The measurement standard should require that the overall system measurement error not be degraded below that allowed for direct measurements, regardless of the instrumentation configuration.

13.1. General Requirements

Instrumentation for noise measurements consists, generally, of the components shown in Figure 16. The sound pressure is converted into an electrical signal by a microphone. This signal is amplified and passed through a filter which weights the various frequency components of the signal. The filtered a-c signal is then detected (usually converted to a d-c value equivalent to the root-mean-square value of the a-c signal) and averaged over an appropriate time interval. This detected signal is then displayed via some read-out device. The signal may be recorded on a magnetic tape recorder and brought back to the laboratory for analysis. If this is necessary, the recording and playback operation should not degrade the overall measurement error below that allowed for direct measurements.



Figure 16. Schematic representation of instrumentation for sound level measurements.

In acoustical measurements where a frequency analysis is required, it has been traditional to use a bank of band pass filters, and switch through them sequentially to obtain sound pressure levels in each frequency band. More recently, real-time analyzers have become available which have parallel filters, with detection and read-out for each frequency band. The output of these can be read visually or they can be interfaced to a computer. Alternatively, the instantaneous voltage from the microphone can be passed through an analog-to-digital converter which is interfaced to a computer. Digital data are taken at a rate at least twice the highest frequency of interest. Filtering and detection are done digitally within the computer.

Any of these techniques is acceptable if done properly. In the discussion below it will generally be assumed that the various elements in Figure 16 are analog devices which can be treated separately. However, the measurement standard should apply to the overall measurement process and not assume any particular configuration of components.

13.2. Microphone and Cable

There are a number of different types of microphones in use. For acoustical measurements, condenser, electret, and piezoelectric microphones are most common although dynamic microphones are still used occasionally.

The important features of microphones are frequency response, sensitivity, and freedom from adverse environmental effects. The American standard[29] for reverberation room determinations of sound power requires that:

"The microphone shall have a flat frequency response for randomly incident sound over the frequency range of interest. The microphone shall meet the requirements of ANSI S1.12-1967. The microphone and its associated cable shall be chosen so that their sensitivity does not change by more than 0.5 dB in the temperature range encountered in the measurement. If a moving microphone is used, care shall be exercised to avoid introducing acoustical or electrical noise (e.g., from gears, flexing cables, or sliding contacts) that could interfere with the measurements."

An American standard[40] describes types of laboratory microphones that are suitable for calibration by an absolute method such as the reciprocity technique described in the American standard for the calibration of microphones[41].

13.3. Frequency Response of the Instrumentation System

The American[37] and international[42,43] standards for sound level meters prescribe tolerances on frequency response, omni-directional response, and the effects of environmental conditions.

The American standard states that:

"the frequency response of the instrumentation calibrated for randomly incident sound shall be determined according to the procedures of ANSI S1.10-1966 and the random incidence response shall be uniform within the tolerances given below:

Frequency Hz	Tolerance Limits dB
50 to 80	± 1.5
100 to 4000	± 1
5000 to 8000	± 1.5
10000	± 2

13.4. Weighting Network and/or Frequency Analyzer

If direct measurements are to be made of the A-, B-, or C-weighted sound level, the measurement standard should clearly reference the allowable tolerances on the frequency weighting. The international standard for precision sound level meters[43] gives tolerances for all three weighting networks. The American standard[37] defines three types, or classes, of sound level meter with different tolerances. The American Type 1 tolerances[37] are essentially identical to the international tolerances[43] except below 100 Hz where the American tolerances are tighter.

It is anticipated that frequency analyses required for regulatory actions will not require measurements in frequency bands narrower than 1/1- or 1/3-octaves. The international standard for band-pass filters[44] defines the center frequencies and sets limits on terminating impedances, effective bandwidth, attenuation in the pass-band, attenuation outside the pass-band, overall tolerances, harmonic distortion, and the effects due to environmental conditions. The American standard[45] is a rather more detailed document which establishes three classes of band filters, Classes I and II for octave band filters and Classes II and III for half-octave and third-octave band filters.

The choice of a filter for a given measurement is based upon the accuracy required. The bandwidth error of a filter depends upon its transmission loss at the band edges, the slope of the transmission loss characteristic outside the band, and the input noise spectrum slope. Appendix B of [45] discusses the subject and gives data and references allowing selection of filter characteristics which will yield measurements falling within specified error limits at various noise spectrum slopes.

The international tolerances[44] are less restrictive than the American Class III but somewhat more restrictive than Class II. The American standard for determination of sound power in reverberation rooms[29] requires that "an octave band or one-third octave band filter set meeting at least the requirements for Class II filters of ANSI S1.11-1966, or latest revision,

BEST AVAILABLE COPY

shall be used." International standards[10,11] and draft standards[12-14] for sound power determination specify a band filter set meeting the requirements of [44].

13.5 Signal Detection and Averaging

The electric signal from a microphone is typically comprised of the sum of components at many frequencies. The measuring instrumentation should "detect" the root-mean-square value of this signal, defined as

$$E_{\text{rms}} = \left[\frac{1}{T} \int_0^T [e(t)]^2 dt \right]^{1/2} \quad (39)$$

where $e(t)$ is the time varying voltage and, T , the integration time, should be long enough to provide adequate averaging.

Many voltmeters measure the average absolute value of the signal, defined as

$$E_{\text{avg}} = \frac{1}{T} \int_0^T |e(t)| dt \quad (40)$$

The value of E_{avg} is uniquely related to E_{rms} for a sinusoidal signal so that rectified average detectors are quite satisfactory for that purpose. However, they can result in very large errors for more complex signals. Table 5 indicates the error of a rectified average meter for several types of signals. Since typical noise signals differ considerably from pure sine waves, it is important to specify a true rms detector. The International standard on precision sound level meters[43] requires that instrumentation complying with that standard be able to measure the combination of signals of two non-harmonic frequencies to within ± 0.1 dB of the true rms value.

After the signal is "detected", it is necessary to carry out the integration indicated in eq. 39. Preferably, this should be done using a "true integrator", either analog or digital. Many acoustical instruments utilize RC-averaging in which the squared signal is the input to a low-pass RC-filter. If the rms value of the input voltage to an RC-integrator is changed from one value to another (e.g., the system is switched to a different microphone or filter), the output of the integrator will vary with time as

$$E = E_1 e^{-t/RC} + E_2 (1 - e^{-t/RC}) ; \quad (41)$$

the initial value E_1 decays with a time constant RC and the new value E_2 is approached asymptotically with the same time constant. In terms of the voltage change,

$$\frac{E - E_1}{E_2 - E_1} = 1 - e^{-t/RC} \quad (42)$$

Table 5

Wave Form	Error in reading of rectified average meter
	dB
Sine Wave	0
Sine Wave Plus 100% Third Harmonic in Phase	-0.50
Sine Wave Plus 100% Third Harmonic out of Phase	-6.52
Square Wave	+0.91
Gaussian Noise	-1.04
Pulse Train: 10% on and 90% off	-9.14
Pulse Train: 1% on and 99% off	-19.17

Table 6

t/RC	$1 - e^{-t/RC}$	$20 \log_{10}(1 - e^{-t/RC})$
1	0.632	-3.98 dB
2	0.865	-1.26
3	0.950	-0.44
4	0.982	-0.16
5	0.993	-0.06
6	0.998	-0.02
7	0.999	-0.01

Table 6 shows this function for different times after the integrator input is switched from E_1 to E_2 .

Thus if there originally was no input to the integrator, one should wait 5 time constants for the output of the integrator to be within less than 0.1 dB of its final value.* Similarly, if one wishes to take successive independent readings of the same signal, an interval of several time constants should be allowed.

For nondeterministic, or random, signals (see Section 11) the averaging time must be sufficiently long for the statistical error to become small enough to be acceptable. For bandwidth limited Gaussian white noise, the standard error (normalized) in the root-mean-square pressure (or voltage) is given approximately by

$$c = \sqrt{\frac{1}{B_e T}}$$

where T is the averaging time and B_e is the effective bandwidth of the filter. The 90, 95, and 99 percent confidence limits for bands of random noise are shown in Figure 17 as functions of bandwidth and averaging time. For additional details see [46-47].

In the case of a deterministic process, the averaging time depends only on the response of the filter and detector. That is, one must wait long enough for the filter to respond to the signal and for the detector to respond to the signal. If one defines the rise time of a filter as the time it takes for response to rise from 10% to 90% of its final signal, then the rise time, τ_r is $\tau_r = 0.88/B_e$ where B_e is the effective bandwidth of the filter. If an RC-integrator is used in the detector and a 0.1 dB error is accepted, compared to the response to a unit step change in voltage of a true integrator, one must wait 5 RC time constants. The total observation time should be

$$\frac{0.88}{B_e} + 5RC$$

In most cases of concern, the rise time will be much less than 5 RC time constants.

13.6. Read-Out Device

If the averaging has been accomplished by a true or RC integrator, the readout can be in analog form via a meter or a strip chart recorder, or digitally through a digital voltmeter or a computer. If the averaging was done digitally, the read-out would usually be via a computer.

*The squared voltage from the detector will contain a-c components superimposed on the mean-square value. Each frequency component will be attenuated in squared-voltage amplitude by $(1/\omega RC)^2$. For small values of RC, this can result in noticeable "ripple voltage" passing through the integrator if there is considerable low frequency voltage present.

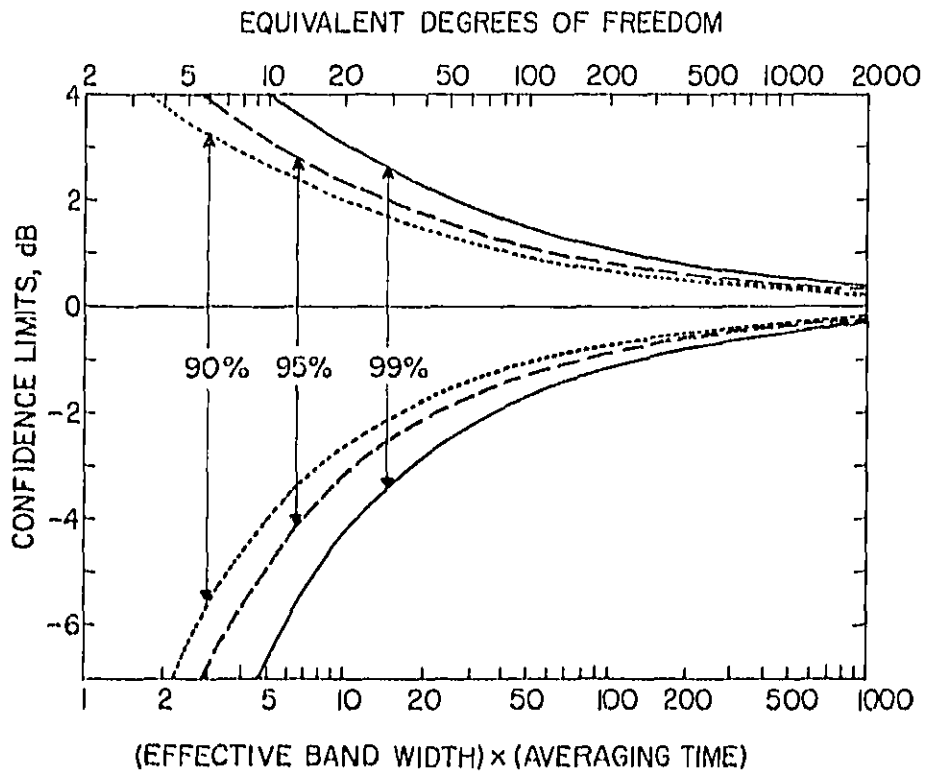

Figure 17. Confidence intervals as functions of BT for measurements on random noise.

SECRET AVIAN ADI E 000000

Graphic level recorders are frequently used to provide a time history of sound level. When used for such purposes, the paper speed and, especially, the writing speed should be selected carefully and should be reported with the results of the measurement. When graphic level recorders are used in conjunction with a filter to provide read-out of frequency analyses, the writing speed should be carefully selected with regard to the frequency sweep speed[48,49].

It is quite common to use a slow writing speed on a graphic level recorder in an attempt to obtain a long averaging time such as might be indicated in reverberation room measurements. Typically, there is an RC integrator, following the square-law detector, which has a low effective averaging time T_1 . The writing speed of the recorder in effect acts as another integrator with an averaging time T_2 . Thus the recorded level is

$$A = \frac{1}{T_2} \int_0^{T_2} \left[\frac{1}{T_1} \int_0^{T_1} [e(t)]^2 dt \right]^{1/2} dt \quad (43)$$

If $T_1 > T_2$, the system is unstable. However, if T_2 is chosen to be much greater than T_1 and the frequencies of the fluctuations in the detector input level are of the order of $1/T_1$, the recorded signal level will be the "mean detected value" (i.e., "mean rms"). This quantity is of dubious physical meaning and from a theoretical point of view it would be better to increase T_1 and eliminate the second integration[46].

13.7. Transient Response of Instrumentation System

Although noise measurement instrumentation with different principles of operation may be calibrated to yield the same results on steady-state signals, such may not be the case for transient effects such as motor vehicle pass-bys. For one example of the differences among various measurements of time-varying noise, see [50]. It is recommended that measurement standards for sources which produce transient sounds include specific criteria for system response to one or more well-defined transient events (e.g., a pure tone that is amplitude-modulated in a specified manner).

13.8. Calibration and Maintenance of Instrumentation System

An acoustical instrumentation system can be quite complex. Accordingly, it is necessary to calibrate the overall system frequently and not to rely on the system performance being acceptable simply because each component of the system appears satisfactory.

The American standard for the measurement of sound pressure levels[8] includes the following statement with regard to calibration and maintenance of instrumentation:

"The instruments used for the acoustical measurements shall be serviced at least once every twelve months in accordance with the manufacturer's

instructions. This shall include checking the performance of all mechanical components and electrical circuits and replacing substandard items. The date of most recent servicing shall be written on tags attached to the instruments. To ensure that the calibration of the equipment has not changed during a series of measurements, the instrumentation system shall be calibrated acoustically according to the manufacturer's instructions. A comparative calibration provided by a sound-level calibrator or pistonphone of known sound pressure level is usually satisfactory for this purpose. The frequency response of the complete instrumentation system shall be checked periodically to insure that the requirements of 5.4.2 are satisfied. For the laboratory method, microphones shall be calibrated by comparison with reference standard microphones which are calibrated according to American National Standard Method for the Calibration of Microphones, S1.10-1966 (see Section 12)."

13.9. Precautions to be Taken When Selecting Instrumentation

The following is also taken from the American standard for measurement of sound pressure levels[8]:

"5.7.1 Precautions (Field and Laboratory Methods)

5.7.1.1 Wind (Field Method Only). To perform sound pressure level measurements in a moving air stream, a suitably designed windscreen or nose cone shall be utilized to minimize the influence of the air stream on the output of the microphone. No such precaution is necessary if the wind noise is 10 or more decibels below the signal being measured in each frequency band of interest. Corrections for changes in microphone sensitivity for the windscreen or nose cone used during the measurements shall be applied to the observed sound pressure levels.

5.7.1.2 Humidity and Temperature. High humidity or temperature will change the sensitivity or damage many types of microphones. The microphone manufacturer's instructions shall be carefully followed to avoid such effects.

5.7.1.3 High Sound Pressure Levels. Many piezoelectric, moving-coil, and capacitor microphones may be used for the measurement of sound pressure levels up to approximately 140 dB re 20 $\mu\text{W}/\text{m}^2$. At higher levels, specially designed microphones with stiff diaphragms shall be used; these shall be calibrated at the levels to be measured and, if possible, over the entire frequency range of interest. At high sound levels, special precautions shall be taken to ensure that "microphonics" are not generated by the transmission of mechanical vibration to the microphone or instrumentation. These include:

(1) Installing the microphone and instrumentation on a soft mounting.

(2) Removing the instrumentation from the high sound levels and utilizing long cables: precautions are necessary to minimize cable

noise, that is, the noise produced when the cable itself is subject to vibration or flexing.

(3) Installing the instrumentation behind suitable barriers or enclosures: a mechanically soft mounting shall be used for the low-sensitivity microphones that are utilized for the measurements of high sound levels.

(4) Determining electrical noise and possible "microphonics" problems by replacing the microphone with a highly insensitive (dummy) microphone.

5.7.1.4 Low Sound Pressure Levels. A microphone used to measure low sound pressure levels must have high sensitivity and low internal noise. When connected to suitable low-noise amplifiers, many piezoelectric, moving-coil, and capacitor microphones are suitable for measurements of sound pressure levels below 20 dB re 20 $\mu\text{N/m}^2$.

5.7.1.5 Low-Frequency Noise. Piezoelectric and some capacitor microphones are suitable for measuring sound pressures at frequencies down to fractions of a hertz. Special amplifiers are required for measurements of low-frequency noise. The low frequency sensitivity of a microphone may vary considerably from the mid-frequency sensitivity due to the presence of a pressure-equalizing leak. Calibration shall be performed over the frequency range of interest.

5.7.1.6 High-Frequency Noise. For measurements above 20000 Hz. miniature capacitor or piezoelectric microphones usually give the most satisfactory results.

5.7.1.7 Hum Pickup. When sound pressure levels are to be measured near electrical equipment, a moving-coil microphone shall not be used. The instrumentation shall be checked to make certain there is no hum pickup in the instruments themselves. Hum can be reduced by moving the instruments away from the source of the magnetic field or by selecting a proper orientation of the instruments with respect to the magnetic field.

5.7.1.8 Cables. When a cable is used between the microphone and the acoustical instrumentation, the system shall be calibrated according to the manufacturer's instructions with the cable in use.

5.7.2 Precautions (Survey Method). Sound-level meters with integral microphones are generally not suitable for a measurement program that requires the observance of the special precautions of 5.7.1.

5.7.3 Additional Effects on Measured Data

5.7.3.1 Effect of Observer and Meter Case on Measured Data

5.7.3.1.1 Survey Method. The sound-level meter shall be held in front of the observer. The observer shall be oriented with respect to

the principal sound source so that the sound energy arrives at the microphone from the side unless some other orientation is specified by the instrument manufacturer.

5.7.3.2 Field and Laboratory Methods. In order to minimize the obstacle effect caused by the insertion into the sound field of the sound-level meter and the experimenter holding it, the microphone shall be connected to the sound analysis equipment by means of an appropriate cable or extension connector and mounted on a tripod or other suspension system. The observer and all acoustical instrumentation except microphone(s), associated preamplifiers and cables should be located outside the test area.

5.7.3.2 Microphone Response and Orientation

5.7.3.2.1 General. The microphone calibration applied to compute sound pressure level shall conform to the way the microphone is used in the measurement; for example, free-field calibration at the appropriate angle of incidence. It should be recognized that microphone calibrations are often furnished in terms of the pressure response, which may differ from the free-field response at high frequencies by as much as 9.5 dB for one-inch diameter microphones.

5.7.3.2.2 Survey Method. See 5.7.3.2.1

5.7.3.2.3 Field and Laboratory Methods. The microphone shall be oriented with respect to the source so that sound strikes the diaphragm at the angle for which the microphone was calibrated to have the flattest frequency response characteristic. The variation of the response with frequency shall be taken into account in each frequency band for maximum accuracy. It should be noted that microphones are usually most sensitive for sound propagating perpendicular to the microphone diaphragm. However, the angle required to obtain the flattest response vs frequency will be a function of the microphone design. It is imperative that reliable calibration data be used to determine the angle of operation for the flattest response. It should be noted that a microphone may be extremely sensitive at high frequencies to small changes in orientation for sound waves arriving parallel to the diaphragm. Therefore, during a measurement of sound which contains significant high-frequency components, it is advisable to maintain the microphone orientation to within ± 5 degrees for the survey and field methods and to within ± 2 degrees for the laboratory method."

14. Installation and Operation of Source

- *The measurement standard should specify that the device under test be located in its use configuration or alternatively the location should be governed by the test environment and the quantity to be measured, e.g., source located near the center of the room for anechoic measurements of sound power.*
- *The measurement standard should specify that the device under test be mounted under conditions similar to those recommended for normal installation. Care should be taken to ensure that (1) adequate isolation is provided to minimize extraneous airborne noise due to vibration excitation and (2) the process noise does not exceed the sound of the device itself.*
- *The measurement standard should require the input mass and energy and the output energy to be brought to and removed from the source under test without influencing the quantity being measured.*
- *The measurement standard should specify the number of operational modes under which tests are to be carried out.*
- *The measurement standard should specify the extent of the loading and the manner of application of the load to the source under test so these are similar to actual use conditions wherever possible.*

The noise level produced by a specific device is not only dependent upon the sound radiating characteristics of the machine itself but also on the way the machine is operated and/or installed and the specific environment in which it is used. In setting noise limits for such devices through noise emission or labeling standards, test procedures and measurement methodology should include such items as loading, operating speeds, installation requirements, and the location and specification of needed auxiliary equipment.

14.1. Source Location

Sound pressure level measurements for a given device are obtained by measuring at a specified distance from the source in essentially free-field conditions. For sound power determinations, in an acoustically controlled environment, the source is usually located near the center of the room for anechoic measurements, near the center of the floor for hemi-anechoic measurements, while for reverberant measurements the source could be located at various locations. For devices normally mounted on or against a wall, they should be tested in their "use configuration."

As an example of a typical source location specification, consider American Society for Heating, Refrigerating, and Air-Conditioning Engineers

Standard Methods for Testing for Sound Rating Heating, Refrigerating, and Air-Conditioning Equipment[51]:

"5.1 EQUIPMENT LOCATION

The equipment to be tested shall be placed in the sound test room in a position representative of normal usage (see Fig. 1.)

5.1.1 Equipment Used Against a Wall: Equipment normally used against a wall shall be positioned against a wall, at least 5 ft from a corner of the room, and not on a center line of the wall.

5.1.2 Equipment Used Away From a Wall: Equipment normally mounted on the floor or ceiling away from a wall shall be located no closer than 5 ft to any wall, and away from any position of room symmetry.

5.1.3 Equipment Mounted Through Window, Wall or Ceiling: Equipment normally mounted through a window, wall or ceiling shall be located at least 5 ft from any corner and away from any position of room symmetry, except that equipment normally mounted near a corner shall be located at the normal distance from such corner."

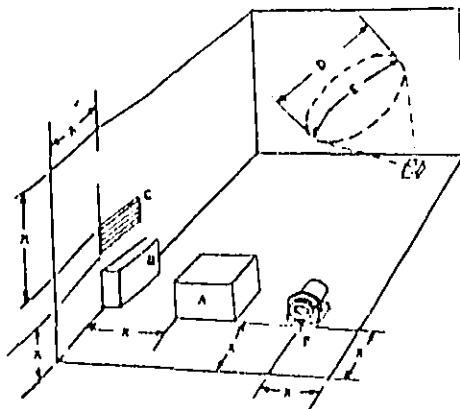

- A = Equipment location, Par. 5.1.2
- B = Equipment location, Par. 5.1.1
- C = Equipment location, Par. 5.1.3
- D = Diameter of circular microphone traverse
- E = Length of microphone traverse (arc or linear)
- F = Location of reference sound source, Par. 5.2
- X = 5 ft minimum

Fig. 1 Location of Equipment in the Test Room

Except for devices normally mounted on or against walls, the most critical requirement is that sources not be located nearer to a wall, edge, or corner than a distance of approximately $\lambda/4$, where λ is the wavelength of the lowest frequency of interest. When sources are located near reflecting surfaces the sound power output is changed.

14.2. Source Mounting and Installation

The acoustic radiation of a device can depend on its installation. In general, the device to be tested should be mounted under conditions similar to those recommended by the manufacturer for normal installation. If a given machine is to be securely bolted to a heavy concrete floor in use, it should be tested that way. Many times it is impractical to simulate mounting conditions such as exist in the actual machine installation. In this case, the usual alternative is to use a very resilient mounting. Since devices can produce forces which may excite vibration in the base, floor, or surrounding structure, and since these may in turn produce airborne noise, precautions should be taken to ensure that adequate vibration isolation is supplied so that extraneous airborne noises of this type are minimized.

The mounting specifications should be well-defined -- either the final use mounting configuration or a resilient mounting should be utilized. Tests should not be conducted using other mountings. As an example of the level of detail needed to adequately specify the mounting/installation of the device during test, American Society for Heating, Refrigerating, and Air-Conditioning Engineers Standard Methods of Testing for Sound Rating Heating, Refrigerating, and Air-Conditioning Equipment[51] is again cited.

"5.4.3 To minimize wall vibration effects, the mounting wall shall be of heavy masonry or equivalent, or an auxiliary mounting platform similar to that shown in Fig. 2 shall be provided.

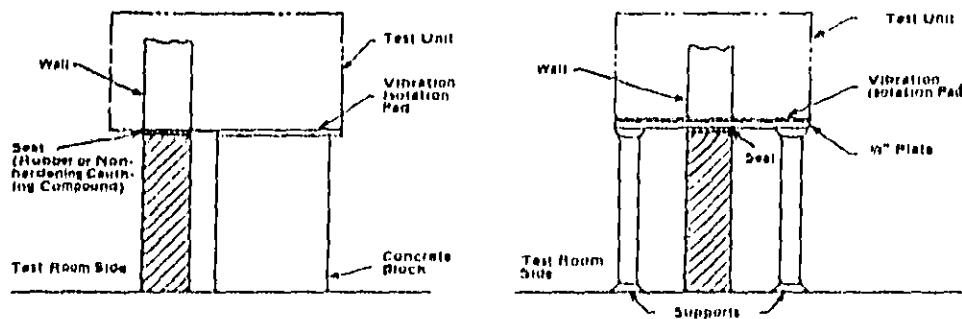

Fig. 2 Auxiliary mountings

5.4.4 The equipment shall be mounted according to the manufacturer's instructions. Openings between the equipment casing and wall shall be sealed with a gasketed sound isolation plug similar to that shown in Fig. 3."

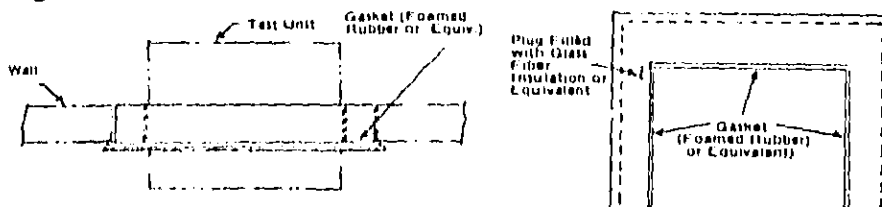

Fig. 3 Typical sound isolation plug

Mounting problems during test are not limited to stationary equipment. For instance, the Compressed Air and Gas Institute - Test Code for the Measurement of Sound from Pneumatic Equipment[52] specifies that in cases where the process noise far exceeds the sound output of the machine itself, e.g., riveters, and it is necessary to consider the machine on its own, "it should be run with the working tool embedded in a shock absorbing body whose secondary sound level is at least ten (10) dB below the machine's own output in each octave band of interest. (For example, the tool is to be embedded in or running on rubber, sand, etc.)."

For in-situ measurements, either indoors or out-of-doors, made on non-stationary sources, e.g., motor vehicles, no special provisions are usually necessary concerning mounting or installation.

14.3. Auxiliary Equipment

In general, machines are governed by the conservation of energy principle relating the balance of input/output energy. For example, the fuel (gasoline) that is used in an automobile is converted into power (including noise and vibration) and heat during the combustion process. It should be obvious that this energy flow must be accounted for during noise measurement tests, especially those conducted in enclosed spaces such as anechoic or reverberation rooms. If a car is to be tested in an anechoic room, the room must be cooled to dissipate the heat produced by the combustion process, the exhaust emissions must be removed from the room, and the power to the wheels must be dissipated through a dynamometer.

In the case of an automobile the output energy is the main problem. For devices which operate on electricity, the input energy is also a problem. A good power supply is necessary to supply any piece of electrical machinery during test. Machine noise may be influenced by irregularities in the power supply output. Noise in alternating current motors may be influenced by voltage unbalance and/or harmonic content; noise in direct-current motors may be affected by ripples in the power supply.

Auxiliary equipment may also be a problem out-of-doors. The diesel train locomotive, for instance, incorporates a diesel engine which drives an electrical generator which in turn provides power to traction motors on each axle of the locomotive. The diesel engine is water cooled and utilizes water-to-air heat exchange radiators and associated cooling fans. Dynamic braking is used on many locomotives to slow the locomotive and train at higher speeds or on steep grades. This is accomplished by disconnecting the traction motors from the main generator and using them as generators. The high electrical currents that result are dissipated as heat through heavy duty resistor grids with the use of separate cooling fans located in the roof of the locomotive. When such a locomotive is evaluated for noise emission utilizing a stationary test, the generator load output must be dissipated into a resistor grid load box. This load box facility must be isolated from the locomotive under test so that the grid cooling fan noise will not affect the measurements.

The basic requirement is that the input mass and energy -- gasoline, air, electricity, etc. -- and output energy -- power, heat, air emissions, etc. -- be brought to and removed from the device under test without influencing the quantity being measured.

Such requirements should be specified in the measurement standards. American Society for Heating, Refrigerating, and Air-Conditioning Engineers Standard Methods for Testing for Sound Rating Heating, Refrigerating, and Air-Conditioning Equipment[51] stipulates the following requirements for auxiliary equipment:

"5.5 AUXILIARY FACILITIES FOR SOUND TESTING AIR CONTROL & TERMINALS (ACT) DEVICES

5.5.1 General

5.5.1.1 A quiet air system shall be provided and arranged to absorb sound generated by the fan or duct system so that it does not affect measurements of sound power generated by the ACT device. Correction to sound measurements for background noise from the fan or duct system shall not be permitted.

5.5.1.2 Background sound entering the test room through paths not involving the ACT device are corrected per Table III, provided that the background sound level in the test room is measured with the air duct into the test room blanked and the exterior noise shall not exceed that

to prevail during measurement of the sound generation of the ACT device.

5.5.1.3 Air flow control accessories (damper, deflectors, straighteners, equalizers, etc.) normally used in conjunction with the ACT device under test, whether an integral part of the device or not, shall be included in the test setup. They shall be located and set in the same manner recommended for the application of the ACT device.

5.5.1.4 ACT devices shall be tested with an outlet duct of recommended size terminating in the test room. In addition, ACT devices which are recommended to be used in combination with lined ducts, elbows or silencers shall be tested together with these with an outlet duct of recommended size terminating in the test room.

5.5.1.5 When required, return air shall be vented from the test room through a sound trap to prevent pressure build-up within the room. All sound measurements of test equipment, reference sound measurements of test equipment, reference sound source and background noise shall be made with the return sound trap in place in a consistent manner, per Par. 8.1.1."

14.4. Operation of Source During Test

The range of noise levels generated by a device is dependent on the range of operational modes. A noise emission or labeling standard should specify tests at a sufficient number of operational modes to fully characterize the device. For example, a truck is characterized by two operational modes although the vehicle can operate over a wide range of speeds under the various loads. Low speed operation is measured by a maximum acceleration test (engine/exhaust noise) while high speed operation is measured by a coastby test (tire noise). The Society of Automotive Engineers Recommended Practice for the Exterior Sound Level for Heavy Trucks and Buses[53] defines in great detail the operational procedure for measuring maximum noise:

"4. Procedure

4.1 Vehicle Operation - Full throttle acceleration and closed throttle deceleration tests are to be used. A beginning engine speed and proper gear ratio must be determined for use during measurements.

4.1.1 Select the highest rear axle and/or transmission gear ("highest gear" is used in the usual sense: it is synonymous to the lowest numerical ratio) and an initial vehicle speed such that at wide-open throttle the vehicle will accelerate from the acceleration point:

- (a) Starting at no more than two-thirds (66%) of maximum rated or of governed engine speed.
- (b) Reaching maximum rated or governed engine speed within the end zone.

(c) Without exceeding 35 mph (56 km/h) before reaching the end point.

4.1.1.1 Should maximum rated or governed rpm not be attained before reaching the end zone, decrease the approach rpm in 100 rpm increments until maximum rated or governed rpm is attained within the end zone.

4.1.1.2 Should maximum rated or governed rpm not be attained until beyond the end zone, select the next lower gear until maximum rated or governed rpm is attained within the end zone.

4.1.1.3 Should the lowest gear still result in reaching maximum rated or governed rpm beyond the permissible end zone, unload the vehicle and/or increase the approach rpm in 100 rpm increments until the maximum rated or governed rpm is reached within the end zone.

4.1.2 For the acceleration test, approach the acceleration point using the engine speed and gear ratio selected in paragraph 4.1.1 and at the acceleration point rapidly establish wide-open throttle. The vehicle reference shall be as indicated in paragraph 3.7. Acceleration shall continue until maximum rated or governed engine speed is reached.

4.1.3 Wheel slip which affects maximum sound level must be avoided.

4.1.4 For the deceleration test, approach the microphone point at maximum rated or governed engine speed in the gear selected for the acceleration test. At the microphone point, close the throttle and allow the vehicle to decelerate to one-half of maximum rated or of governed engine speed. The vehicle reference shall be as indicated in paragraph 3.7. If the vehicle is equipped with an exhaust brake, this deceleration test is to be repeated with the brake full on immediately following closing of the throttle.

4.2 Measurements

4.2.1 The meter shall be set for "fast" response and the A-weighted network.

4.2.2 The meter shall be observed during the period while the vehicle is accelerating or decelerating. The applicable reading shall be the highest sound level obtained for the run, ignoring unrelated peaks due to extraneous ambient noises. Readings shall be taken on both sides of the vehicle.

4.2.3 The sound level for each side of the vehicle shall be the average of the two highest readings which are within 2 dB of each other. Report the sound level for the side of the vehicle with the highest readings."

An operational procedure for measuring tire noise would include the vehicle speed, load per tire, and the pavement surface on which the truck could run. In this case the pavement surface not only has an affect on the propagation of sound but also on the sound generation process.

Devices such as dishwashers and clothes washers operate according to a prescribed cycle and the noise levels generated depend on the particular operational characteristics of each individual portion of the total cycle. A measurement during a single operational mode for such a device would be meaningless. To fully characterize such devices, a measurement would have to be made during the rinse operation, the water filling operation, the spin-drying operation, etc. This is somewhat analogous to the air emission tests conducted on automobiles in which emission measurements are made while the vehicle runs through a prescribed series of operations known as the driving cycle.

The Compressed Air and Gas Institute - European Committee of Manufacturers of Compressed Air Equipment Code for the Measurement of Sound from Pneumatic Equipment[52] specifies for percussive machines the working pressure, the material to be penetrated, the depth of penetration and the feeding force. For other pneumatic tools tests are to be run at no-load (running free), at a rated load and speed, at governed speed under load, at idle, at maximum performance, etc.

To accurately characterize sources having noise levels dependent on the manner in which they are operated, operational constraints, in conjunction with precise measurement and calibration procedures, should be incorporated into the standard measurement procedures.

14.5. Loading of Equipment During Test

A garbage disposal obviously will produce a different noise level when grinding bones than when grinding regular food. Likewise, a dryer with a load of regular wash tumbling sounds very different than if several pairs of tennis shoes are drying. For such devices there is a need for a "standard load" so that comparisons can be made among the noise levels produced by such equipment.

Stationary tests on moving equipment require a different type of loading specification. In such cases a dynamometer or brake may be utilized to apply a specified load to the device under test, thus simulating the road load characteristic of normal vehicle operation.

The static load carried by a vehicle also has an influence on the noise generated by the vehicle. For instance the loaded vehicle weight influences the noise generated by tires. Depending on the tread design, the influence can be significant.

The operational procedure can be such that the loading is not important. Tests run according to the operational procedure specified in SAE J366b[53]

(see Sec. 14.4 for details) are intended to yield the same noise level whether a tractor is tested by itself or the tractor is pulling a load of 70,000 pounds. The operational procedure specified hopefully ensures that the engine is loaded properly and thus the load pulled is not important.

The extent of the loading and the manner of application of the load to a device under test are important considerations which should be addressed. Loading should be similar to actual use conditions wherever possible and operational procedures should include loading requirements along with those for speed, gear selection, and other operational parameters.

15. Measurement Procedures

- The measurement standard should specify the location of all microphone positions.
- The position of the source with respect to the test environment should be defined. If (for example, in reverberation room measurements) multiple source positions may be indicated, criteria should be given for ascertaining how many source positions are required in order to attain the desired level of precision and accuracy.
- The number of observations, and the averaging time for each, necessary for each sound level measurement should be specified in the measurement standard.
- Criteria should be given to enable determining whether the use of diffusors is indicated in reverberation room measurements.
- Procedures for determining background noise should be specified.
- Techniques and procedures for characterizing, or "qualifying" the test environment should be clearly laid out in the measurement standard.
- Instrumentation and facility calibration requirements and procedures should be given.

Previous sections of Part II have included discussions of the acoustic quantities of concern in noise measurements, the types of acoustic environments and how they relate to measurements of sound pressure and sound power, instrumentation used for acoustic measurements, and the influence of the way the source is installed and operated. In the present section, these factors are incorporated into a discussion of overall procedures for conducting acoustic measurements.

15.1. General

It is essential to keep in mind that the sound power radiated by a given source, and the sound pressure at any given location relative to that source, will depend upon the acoustical properties of the environment in which the source is located, the transmission path(s) between the source and the microphone, and the properties of the environment in which the microphone is located -- all in addition to the properties of the source itself.

For a more complete description of sound propagation in a medium, it is useful to introduce the particle velocity, \vec{u} , in addition to the sound pressure, p , and the density, ρ . If the acoustic pressure and particle velocity can be expressed as harmonic functions, then these quantities* are related by:

*An underlined symbol denotes a complex quantity having, in general, both real and imaginary parts. An arrow over a symbol denotes a vector quantity.

$$\hat{u} = \frac{-1}{\rho\omega} \hat{\nabla} p, \quad (44)$$

where $\omega = 2\pi f$ is the circular frequency, $i^2 = -1$, and $\hat{\nabla}$ designates the gradient operator.

In general, p is of the form $Pe^{i\phi}e^{-i\omega t}$, where P is the amplitude and ϕ is the phase angle at $t = 0$. In acoustics it is customary to suppress the time dependence and simply write $p = Pe^{i\phi}$. With this convention, the time-average power per unit area, known as the intensity, is

$$\hat{I} = \langle p\hat{u} \rangle_t = \frac{1}{2} \text{Re} (p^*\hat{u}) = \frac{1}{2} \text{Re} (p\hat{u}^*) \quad (45)$$

$$= \frac{1}{4} (p^*\hat{u} + p\hat{u}^*) \quad (46)$$

$$= P_{\text{rms}} \hat{u}_{\text{rms}} \cos \theta, \quad (47)$$

where $\langle \rangle_t$ designates a time average, θ is the phase angle between the acoustic pressure and the particle velocity, and "rms" indicates the root-mean-square values of pressure and velocity.

The total time-average power flow across any closed surface surrounding the source is

$$W = \int_S \hat{I} \cdot \hat{n} \, dS \quad (48)$$

where \hat{n} is an outward directed unit vector perpendicular to the elemental surface area, dS . The integration is over the entire closed surface. In terms of the root-mean-square pressure and velocity,

$$W = \int_S P_{\text{rms}} \hat{u}_{\text{rms}} \cdot \hat{n} \cos \theta \, dS. \quad (49)$$

Since W represents the total radiated power, it is independent of the size or shape of the surface of integration, providing the medium is non-absorptive.

Ideally, the total sound power emitted by a source would be determined by direct application of eq. (49). Although there have been "intensity meters" constructed (e.g., see[55-61] and there is current interest[62] in this method of sound power determination, intensity meters are not commercially available and there are certain difficulties in applying eq. (49) to real-world situations[63].

It also is of interest to consider the energy density (or total energy per unit volume), w , in the medium through which the sound is propagating:

$$w = \frac{1}{2} \frac{p^2}{\rho c^2} + \frac{1}{2} \rho u^2 ; \quad (59)$$

where $p^2 \equiv |p|^2$ and $u^2 \equiv |u|^2$.

At sufficiently large distances from the source,

$$|\vec{u}| \rightarrow \frac{p}{\rho c} \quad (51a)$$

$$|\vec{I}| \rightarrow \frac{p^2}{\rho c} \quad (51b)$$

$$|\vec{I}| \rightarrow \rho c u^2 \quad (51c)$$

$$w \rightarrow \frac{p^2}{\rho c^2} \quad (51d)$$

$$w \rightarrow \rho u^2 \quad (51e)$$

The region where all of these relations hold true is known as the far field. The particle velocity is in phase with the acoustic pressure (as in the case for a simple plane wave) and there is no reactive component of energy density. Thus all of the energy density is radiant energy. In the near-field region, close to the source, there is a large component of the particle velocity which is out of phase with the acoustic pressure, resulting in reactive energy which does not radiate outward[32].

Since instruments for direct measurement of acoustic intensity are not generally available and since, over the frequency range of interest for many noise sources, acoustic pressure can be measured more readily than particle velocity, it is customary to carry out determinations of the noise emission of sources by measuring the mean-square pressure and assuming that $|\vec{I}| = p^2 / \rho c$. Note that this assumption is often implicitly made whether or not one is interested in computing the sound power. If one measures the sound level due to, say, a motor vehicle passing, one wishes to be able to predict the sound level at other distances from that measured at a particular distance -- this implicitly requires that $I \propto p^2$.

If it is desired to determine the total sound power from measurements of mean-square pressure, eqs. (48) and (49) are replaced by

$$W \approx \frac{1}{\rho c} \int_S p^2 dS ; \quad (52)$$

this equation involves two distinct assumptions:

- the acoustic intensity can be accurately estimated by $p^2/\rho c$.
- the surface of integration has been selected such that the flow of radiant power is normal to that surface at all points on the surface.

Deviations from either of these conditions will result in errors in the determination of sound power. In addition, of course, errors may result from inadequate sampling of the sound field over the surface of integration.

Note that it is necessary for all five conditions given in eq. (51) to be true in order to be in the far field. However, it is only necessary that eq. (51b) be true in order for eq. (52) to be valid. Thus, in some cases, accurate determinations of total sound power may be based on measurements of mean-square pressure even when such measurements are not made in the true far field. An example of this is the periodic simple source which is considered below.

Conceptually, one of the simplest sound sources is a "pulsating sphere" from which acoustic energy is radiated uniformly in all directions into free space. The instantaneous sound pressure due to such a source is, in complex form,

$$p = \frac{P}{r} e^{i\omega(r/c - t)} , \quad (53)$$

where P is the amplitude at unit distance from the center of the source; the real part of eq. (53) is seen to be as given in eq. (1). Using eq. (44), the radial particle velocity is

$$u = \frac{-1}{\rho \omega} \frac{\partial p}{\partial r} = \left(1 + \frac{ic}{\omega r}\right) \frac{P}{\rho cr} e^{i\omega(r/c - t)} . \quad (54)$$

This can also be expressed as

$$u = \frac{P}{\rho cr \cos \phi} e^{i[\omega(r/c - t) + \phi]} , \quad (55)$$

where

$$\phi = \arctan \frac{c}{\omega r} \quad (56)$$

is the phase angle between p and u .

Thus the intensity is given, from eq. (47), by

$$|\vec{i}| = \frac{1}{\rho c} \frac{p^2}{2r^2}, \quad (57)$$

at any radius. The intensity is, of course, radially directed. The total sound power, from either eq. (49) or eq. (52) is

$$W = 4\pi r^2 \cdot \frac{1}{\rho c} \frac{p^2}{2r^2} \quad (58)$$

$$= \frac{4\pi}{\rho c} \cdot \frac{p^2}{2}, \quad (59)$$

which, as it must be, is independent of r .

The energy density at any radius r is given, from eq. (50), by

$$w = \frac{1}{\rho c^2} \cdot \frac{p^2}{2r^2} \left[\frac{1}{2} + \frac{1}{2} \left(1 + \frac{c^2}{\omega^2 r^2} \right) \right]. \quad (60)$$

Thus, the energy density approaches its far-field value only when $(\omega r/c)^2 \gg 1$, or, equivalently, when $(\lambda/2\pi r)^2 \ll 1$, λ being the wavelength of sound at the frequency of interest. Yet, even in the very near field, as $\omega r/c \rightarrow 0$, the intensity and sound power are given exactly by the usual "far-field formulae", eqs. (58) and (59).

For a dipole point source (i.e., two point sources of equal strength but opposite phase located close together) the radial intensity at radius r is related to the mean-square pressure at the same location by [32, p. 312]

$$I_r = \frac{p^2}{\rho c} \left[1 + c^2/\omega^2 r^2 \right]^{-1} \quad (61)$$

Thus, for a dipole source, estimates of sound power based on measurements of mean-square sound pressure will give somewhat high results, the approximation getting better as the distance from the source increases.

For more complicated sources, analytical expressions giving a general description of the relations among intensity, acoustic pressure, and particle velocity are, if attainable, frequently quite complex. Accordingly, the following discussion relates only to the intensity in a particular direction

(for which a simple solution exists) rather than to the total radiated sound power.

Consider a rigid, circular piston of radius, a , located in an infinite rigid baffle, as shown in Figure 1B. If the piston oscillates in the z -direction with a velocity $Ue^{-i\omega t}$, the sound pressure on the z -axis is (see, e.g., [6h, 65])

$$p = \rho c U \left\{ e^{i\omega(z/c - t)} - e^{i\omega[(1 + z^2/a^2)^{1/2}a/c - t]} \right\}. \quad (62)$$

Utilizing eq. (4h), the particle velocity on the z -axis and in the z -direction is

$$\frac{u}{z} = U \left\{ e^{i\omega(z/c - t)} - \frac{z/a}{(1 + z^2/a^2)^{1/2}} e^{i\omega[(1 + z^2/a^2)^{1/2}a/c - t]} \right\}. \quad (63)$$

Using eq. (4j), the axial intensity is

$$I_z = \rho c U^2 \left\{ 1 + \frac{z/a}{(1 + z^2/a^2)^{1/2}} \left[\sin^2 \frac{\omega a}{2c} \left[(1 + z^2/a^2)^{1/2} - z/a \right] \right] \right\}. \quad (64)$$

The intensity is related to the mean-square pressure by

$$I_z = \frac{p^2}{\rho c} \cdot \frac{1}{2} \left(1 + \frac{z/a}{(1 + z^2/a^2)^{1/2}} \right). \quad (65)$$

At $z = 0$, $p^2/\rho c$ overestimates the axial intensity by a factor of two, or 3 dB. As $z/a \rightarrow \infty$, $I_z \rightarrow p^2/\rho c$.

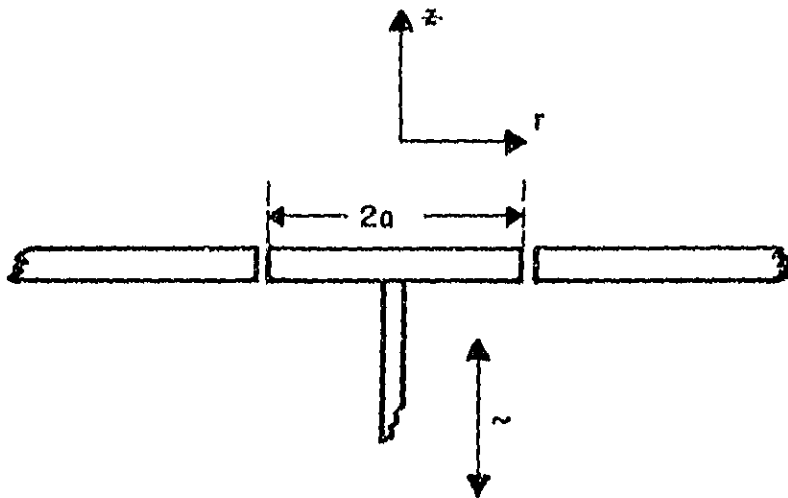

Figure 1B. Schematic representation of a rigid circular piston of radius, a , contained in an infinite baffle.

Figure 19 indicates the variation with distance of the axial intensity level for three values of $\omega a/c$. It is seen that for large $\omega a/c$ both the intensity and pressure level oscillate rapidly for small z/a and do not decrease monotonically until

$$\frac{z}{a} > \frac{1}{2\pi} \cdot \frac{\omega a}{c} = \frac{a}{\lambda}$$

where λ is the wavelength of sound at a frequency $\omega/2\pi$. This phenomenon occurs because sound radiated from different regions on the piston results in interference phenomena. The curves in Figure 19 are normalized to the far-field on-axis levels, extrapolated back, being set equal to 0 dB at $z/a = 1$. The differences, in dB, between the solid curve and the dotted line of slope -6 dB/double-distance represent the errors that would result from predicting far-field on-axis levels from near-field on-axis levels at any particular z/a .

The dashed line in Figure 19 indicates the intensity that would be predicted from far-field measurements of the total radiated sound power rather than that radiated in the z -direction. It is seen that the far-field intensity in the axial direction is greater than the average intensity, particularly for $\omega a/c \gg 1$. This is better seen in the directivity plots shown in Figure 20, where the far-field intensity level is shown, as a function of angle, relative to the average intensity level (i.e., corresponding to the total sound power radiated into the half-space corresponding to positive values of z) [65,66]. For large values of $\omega a/c$, most of the sound power is radiated into a narrow beam along the z -axis.

The rapid oscillations in intensity and sound pressure levels and the directive radiation patterns result from the fact that the piston is a coherent source -- the velocities at all points on the piston have a definite phase relationship with one another (for a rigid piston they are exactly in phase). It is instructive to contrast this with the case where all points on the piston radiate independently with no phase relations. For an ensemble of incoherent point sources, each radiating uniformly in all directions, the intensities can simply be summed and the on-axis intensity due to an incoherent circular source is [67-68]

$$I_z = \frac{\overline{p^2}}{\rho c} = \frac{W}{2\pi a^2} \ln \left(1 + \frac{a^2}{z^2} \right), \quad (66)$$

where W is the total sound power radiated into the half-space (z positive). This is plotted in Figure 21. It is seen that the intensity decreases monotonically with distance away from the piston and approaches its far-field dependence on distance very closely for all values of z/a greater than unity. The far-field radiation from such an incoherently radiating circular source is independent of both angle and frequency.

In order to introduce another phenomenon that is characteristic of sound radiation, consider an infinite plate that is vibrating in flexure as indicated in Figure 22. If the velocity of the plate normal to its surface is described by

$$u(0, y) = U_0 e^{i\omega(y/c_B - t)}, \quad (67)$$

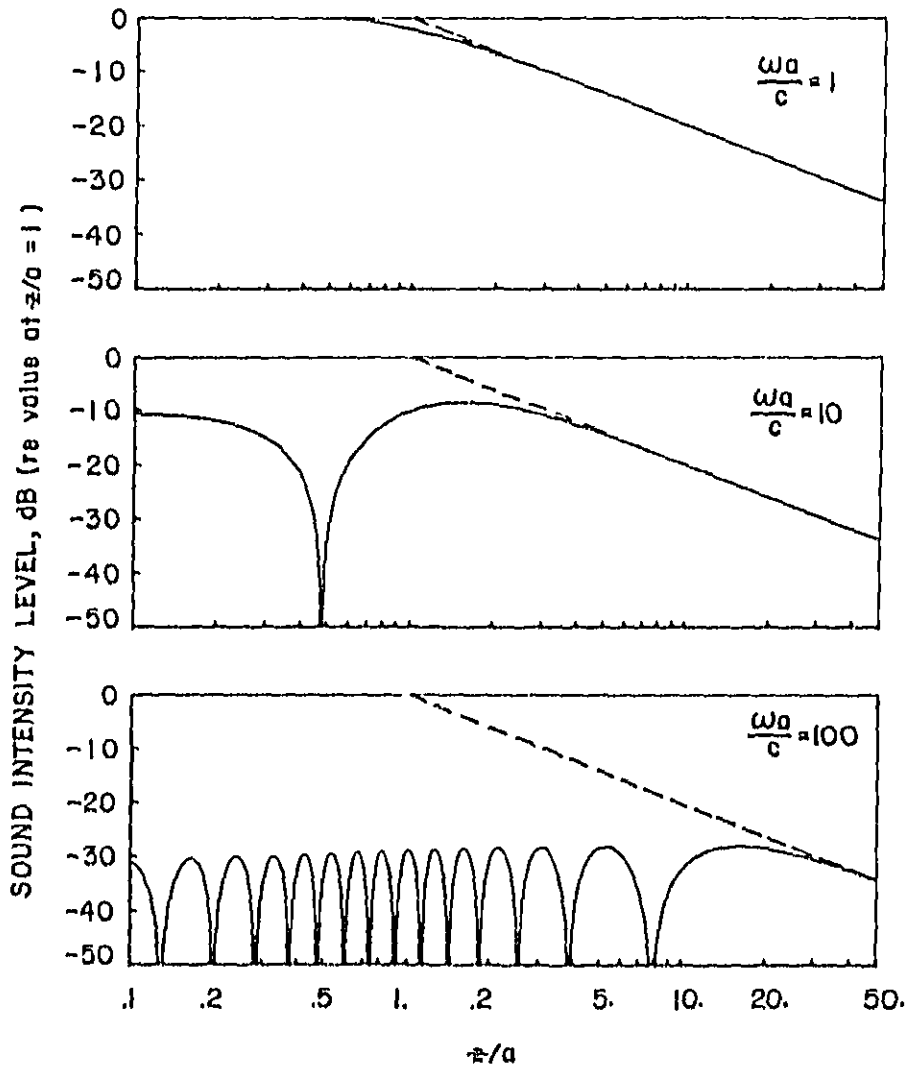

Figure 19. Variation of the axial intensity level due to a baffled rigid piston of radius, a , vibrating at an angular frequency, ω . The dashed lines represent extrapolations of the far-field intensity level back toward the source.

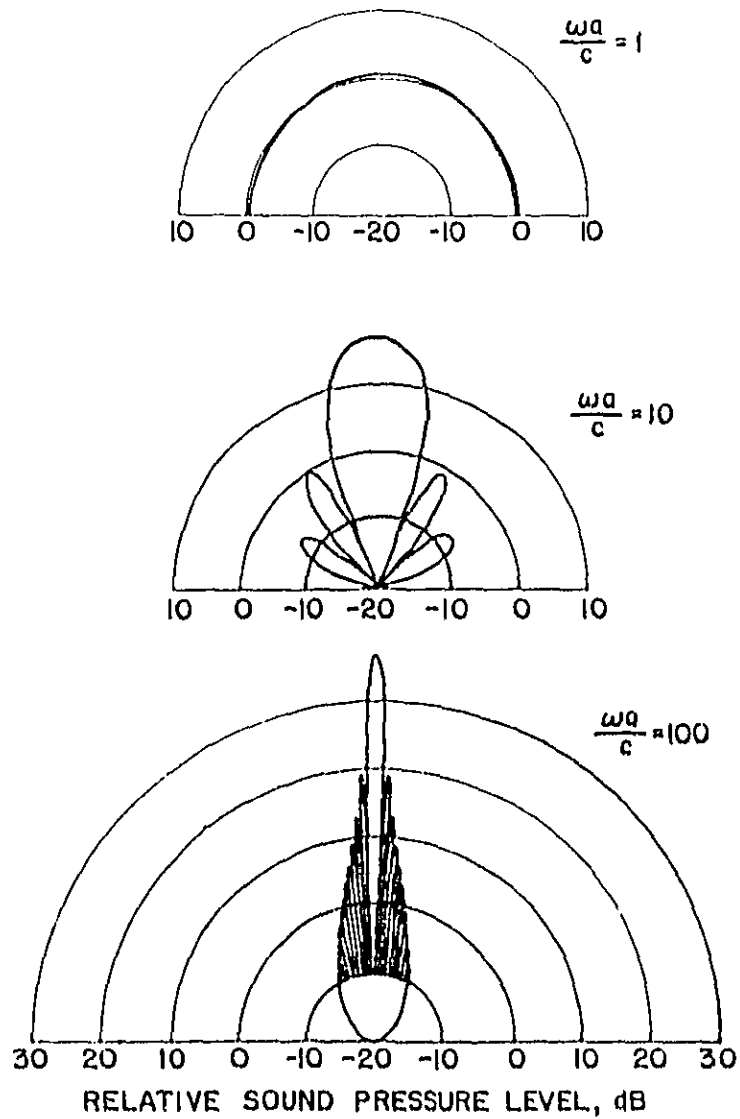

Figure 20. Far-field radiation patterns showing the directionality for a baffled rigid piston.

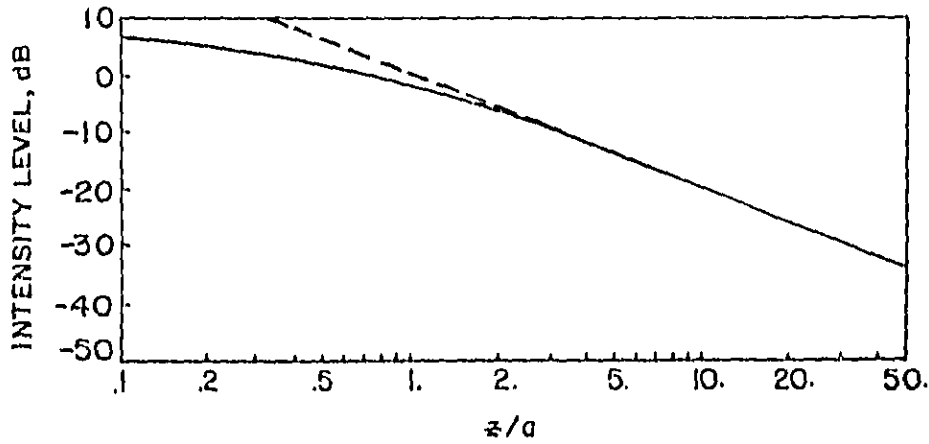

Figure 21. Axial intensity level due to an incoherent circular source.

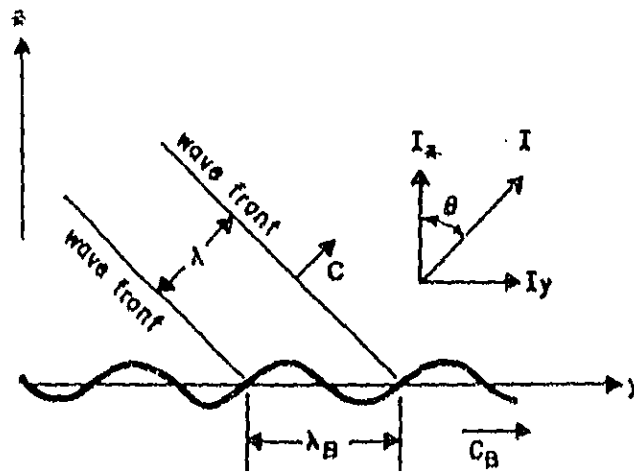

Figure 22. Schematic representation of sound radiation from an infinite plate in which there is a plane bending wave propagating at speed, c_B .

where c_B is the velocity of sound for flexural (bending) waves in the plate, the sound pressure can be shown to be [33, 69, 70]:

$$p(z, y) = \frac{\rho c U}{\sqrt{1 - c^2/c_B^2}} e^{i\omega[y/c_B + z\sqrt{1 - c^2/c_B^2}/c - t]}, \quad c_B > c \quad (68a)$$

$$= \frac{-i\rho c U}{\sqrt{c^2/c_B^2 - 1}} e^{-\omega z\sqrt{c^2/c_B^2 - 1}/c} e^{i\omega[y/c_B - t]}, \quad c_B < c. \quad (68b)$$

When $c_B > c$, the pressure at $z = 0$ is in phase with the velocity; when $c_B < c$, the pressure and velocity at $z = 0$ are out of phase.

The velocity, c_B , of flexural waves in an infinite plate is not constant but is related to frequency by

$$c_B = a\sqrt{\omega}, \quad (69)$$

where a is a constant which is dependent upon the plate thickness and elastic properties. Introducing a "critical frequency", $\omega_0 \equiv c^2/a^2$, and using eq. (44), the particle velocities in the z - and y -directions are

$$\frac{u}{z} = \frac{\sqrt{1 - \omega_0/\omega}}{\rho c} p, \quad \omega > \omega_0 \quad (70a)$$

$$= i \frac{\sqrt{\omega_0/\omega - 1}}{\rho c} p, \quad \omega < \omega_0 \quad (70b)$$

$$\frac{u}{y} = \frac{\sqrt{\omega_0/\omega}}{\rho c} p, \quad \text{all } \omega. \quad (71)$$

Using eq. (45), the corresponding intensities are

$$\frac{I}{z} = \frac{\rho c U^2}{2\sqrt{1 - \omega_0/\omega}}, \quad \omega > \omega_0 \quad (72a)$$

$$= 0, \quad \omega < \omega_0 \quad (72b)$$

$$\frac{I}{y} = \frac{\rho c U^2}{2} \frac{1}{\sqrt{\omega/\omega_0} - \sqrt{\omega_0/\omega}}, \quad \omega > \omega_0 \quad (73a)$$

$$= \frac{\rho c U^2}{2} \frac{1}{\sqrt{\omega_0/\omega} - \sqrt{\omega/\omega_0}} e^{-2\omega z\sqrt{\omega_0/\omega - 1}/c}, \quad \omega < \omega_0. \quad (73b)$$

The magnitude of the intensity in

$$|I| = \left[I_z^2 + I_y^2 \right]^{1/2} \quad (74)$$

$$= \frac{\rho c U^2}{2} \frac{1}{1 - \omega_0/\omega}, \quad \omega > \omega_0 \quad (75a)$$

$$= \frac{\rho c U^2}{2} \frac{1}{\sqrt{\omega_0/\omega} - \sqrt{\omega/\omega_0}} e^{-2\omega z \sqrt{\omega_0/\omega} - 1/c}, \quad \omega < \omega_0 \quad (75b)$$

In the case where $\omega > \omega_0$, the power is radiated as a plane wave in the direction θ , where

$$\tan \theta = \frac{|I_y|}{|I_x|} = \frac{1}{\sqrt{\omega/\omega_0} - 1}, \quad \omega > \omega_0 \quad (76)$$

so that

$$\sin \theta = \frac{\sqrt{\omega}}{\omega_0} = \frac{c_B}{c} = \frac{\lambda_B}{\lambda}, \quad \omega > \omega_0 \quad (77)$$

where, as shown in Figure 22, λ is the wavelength of the radiated sound and λ_B is the wavelength of the flexural wave in the plate. The angle, θ , at which the sound is radiated must be such that the radiated wave has a "trace", or projection, onto the plate that is equal to the wavelength of the plate wave.

In the case where $\omega < \omega_0$, there is a near-field intensity, parallel to the plate, which decays exponentially with increasing z . There is no real angle at which sound power is radiated from the plate into the far field.

The theory would indicate that at $\omega = \omega_0$ an infinite amount of power is radiated in a direction parallel to the plate. In practice, the surrounding air loads the plate, infinite power cannot be supplied to the plate, and real plates are of finite extent. Thus the radiated power, albeit large, remains finite.

Figure 23 indicates the power radiated into the far field as a function of ω/ω_0 and shows the direction in which it is radiated. Figure 24 illustrates how the near-field intensity decays with distance away from the plate for $\omega < \omega_0$.

In real plates, the combination of internal damping, air loading, and finite size results in some radiation of sound power into the far field even below the critical frequency.

The above discussions indicate several phenomena that should be kept in mind when carrying out sound power measurements:

- there can be a reactive sound field near the source that does not contribute to the far-field sound power

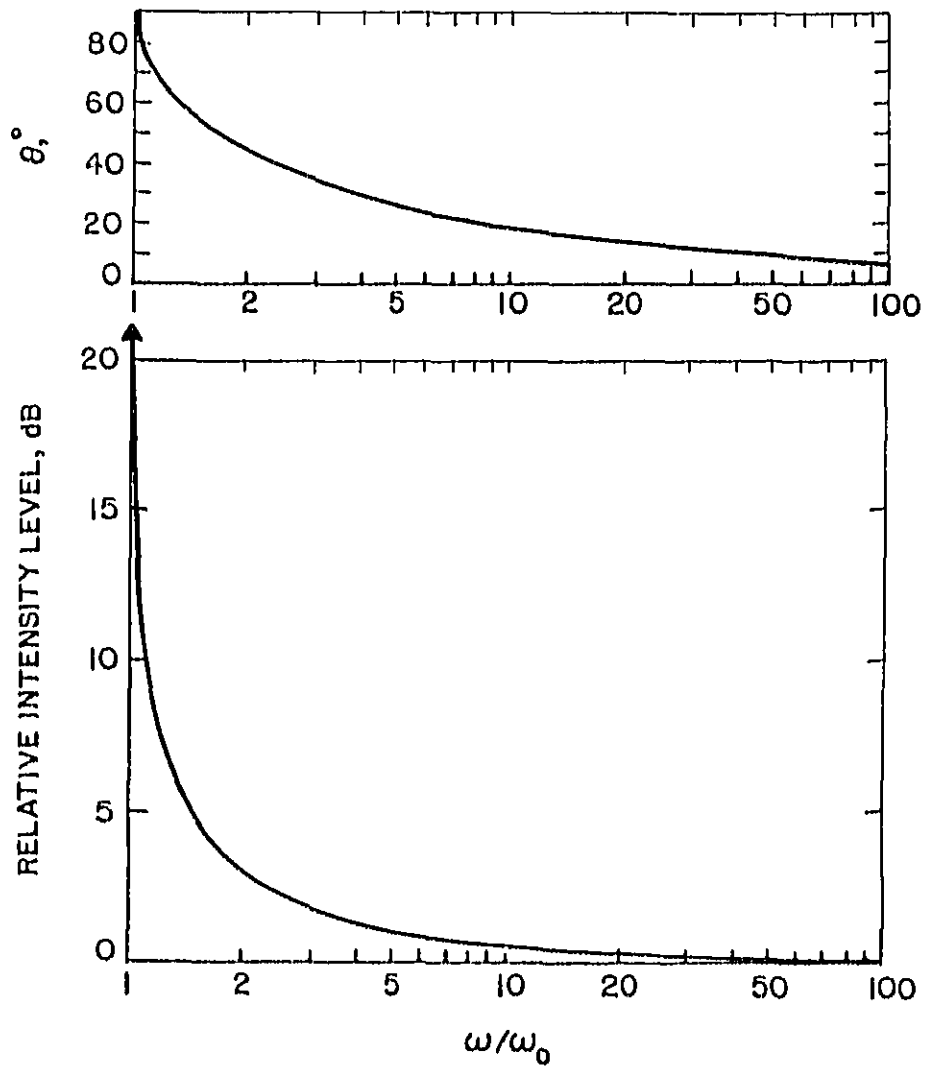

Figure 23. Far-field intensity level (lower figure) above the critical frequency for an infinite plate in flexure. The upper figure shows the direction (relative to the plane of the plate) in which sound is radiated.

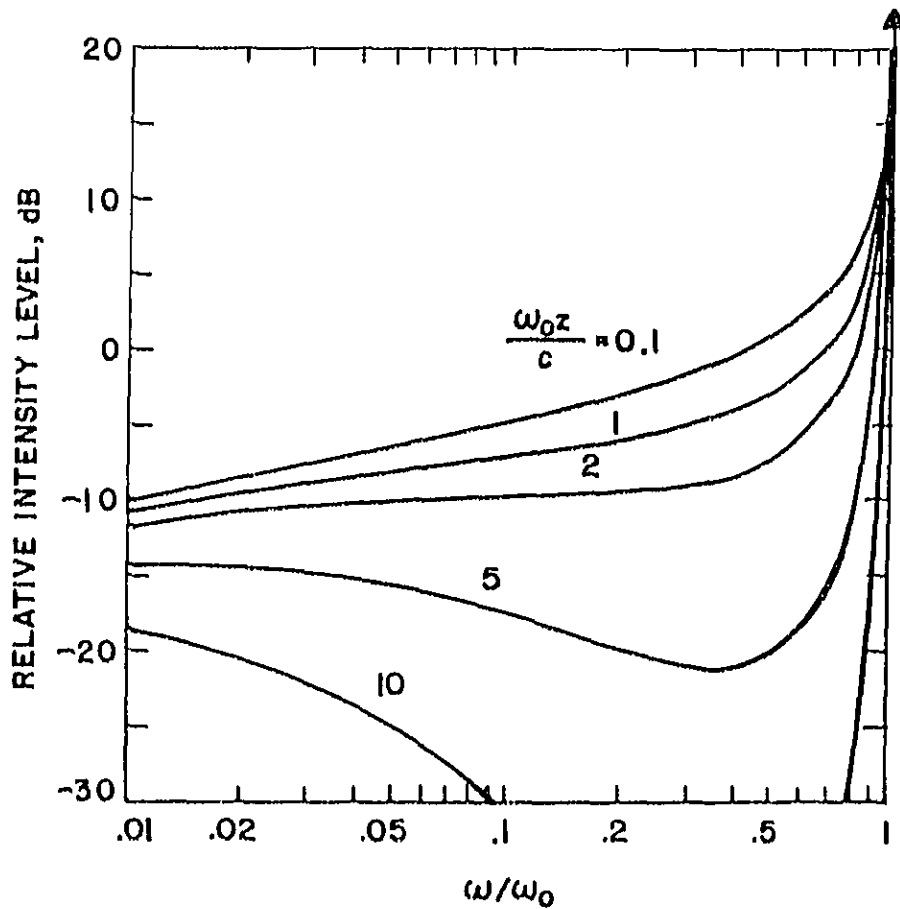

Figure 24. Intensity level parallel to an infinite plate in flexure at frequencies below the critical frequencies. The different curves correspond to different distances from the plate. The reference level (corresponding to 0 dB) is the same as in Figure 23.

- coherently radiating sources are frequently highly directional and in some cases the intensity in a given direction oscillates widely with distance from the source
- vibrating plates have associated with them a "critical frequency" below which very little sound energy is radiated into the far field and above which energy is radiated very efficiently in a specific direction

When sources radiate prominent discrete tones, particular care should be taken to ensure that microphone locations are far enough away from the source (unless, of course, primary interest is in near-field measurements, e.g., at an operator location). For many practical sources, however, reliable sound power determinations can be based on measurements made rather close to the source [5-7].

15.2. Microphone Positions

a. Anechoic Space

If sound pressure measurements are made over a hypothetical sphere, of radius r , surrounding a sound source, the total sound power is given by

$$W = \frac{4\pi r^2}{\rho c} \langle p^2 \rangle \quad (78)$$

where $\langle p^2 \rangle$ is the spatial average of the time-averaged squared sound pressure over the surface of the sphere, provided the conditions for the validity of eq. (52) are met. The total radiated sound power level can be computed from

$$L_W = \overline{L}_p + 20 \log r + 10 \log 4\pi - 10 \log \frac{\rho c}{400} \quad (79)$$

in metric units, where \overline{L}_p is the spatial average of the sound pressure level, the average being taken, \overline{p} on a mean-square pressure basis, over the surface of the sphere.

In carrying out sound power determinations in an anechoic chamber, it is frequently desired to measure the directivity pattern of the noise source. It is customary to define a directivity factor, Q_0 , defined as the ratio of the intensity measured at angle θ and distance r from the source to the average intensity at distance r . Thus,

$$Q_0 = I_0 / \overline{I} = p_0^2 / \overline{p^2} = 10^{(L_{p_0} - \overline{L}_p) / 10} \quad (80)$$

The directional gain, at angle θ , can be defined as

$$DI_0 = 10 \log Q_0 = L_{p_0} - \overline{L}_p \quad (81)$$

The sound pressure level at angle θ and distance r is related to the total sound power and the directivity index by

$$L_{p_0} = L_W + DI_0 - 20 \log r - 10 \log 4\pi + 10 \log \frac{\rho c}{400} \quad (82)$$

The current American standard[71] and the draft international standard[14] for determination of sound power in an anechoic chamber recommend that the sound pressure be measured at locations corresponding to the 20 surfaces of a regular icosahedron. Other possible microphone arrays are given in [72-73]. In lieu of a stationary array of microphones, measurements can be made along a number of continuous paths, either by moving the microphone(s) or by rotating the source (see b., below).

The major considerations in selecting microphone locations for measurements in an anechoic environment are (1) to be far enough away from the source to be assured of being in the far field yet close enough that reflected signals and background noise are negligible compared with the direct signal from the source and (2) that sufficient microphone locations are used to obtain adequate spatial averaging, especially for directional sources. Whenever there is any question concerning these points, it is advisable to make measurements at additional angular positions and/or at two or more radii.

b. Hemi-Anechoic Space

In carrying out measurements in a free field over a reflecting plane, it may be desired to obtain the sound pressure level at one or more specific microphone locations (e.g., a microphone at a distance of 50 feet from the centerline of a passing vehicle) or to obtain the sound power level (with or without directivity information). In the case of sound pressure level measurements, the microphone location(s) is(are) selected to correspond to typical listener locations or to provide information that can be reliably extrapolated to other locations. In the case of sound power level determination, measurements of sound pressure level are typically made over a hypothetical surface surrounding the source. If a hemispherical surface is used, eqs. (79) and (82) apply, but with 4π replaced by 2π and the directivity index computed from

$$DI_0 = L_{p_0} - \bar{L}_p + 3 \text{ dB}, \quad (83)$$

where \bar{L}_p is now the average over the test hemisphere. The 3 dB arises from the fact that averaging is not carried over the space below the plane.

A number of microphone arrays corresponding to hemispherical measurement surfaces are suggested in the literature. The current American standard[71] endorses a 12-point array which is one of several arrays suggested in [72]. Alternative 10-point arrays are given in [72], in [33,13], and in [14]. One recent investigation[7] utilized a 73-point array. In addition to these fixed microphone arrays, it is common to use continuous microphone traverses (either by moving the microphone around the source or by holding the microphone stationary and rotating the source) along circular paths parallel to the reflecting plane. One such configuration is shown in Figure 25.

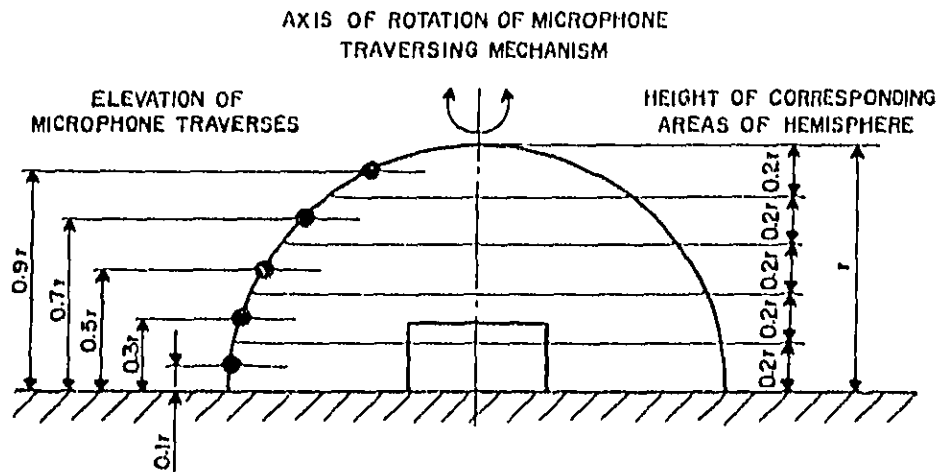

Figure 25. A suggested set of continuous microphone traverses for determination of sound power in a free field above a reflecting plane[14].

Selection of microphone locations for measurements over a reflecting plane is complicated by variations in sound pressure with angle due to constructive and destructive interference between sound waves radiated directly to the microphone and reflected waves. The type of difficulties that may be encountered can be illustrated by considering a point source located above a perfectly reflecting plane. Assuming the measurement locations are sufficiently far away to be in the far field of the source and its image, the variation of sound pressure level with angle is as shown in Figure 26, where the three curves shown correspond to a pure tone, a 1/3-octave band of noise, and a 1/1-octave band of noise. Baade[73], from whom this figure was taken, draws the following conclusions:

"(a) At low frequencies, sound reflection does not cause any significant directivity as long as the wave length is more than 10 times the distance between the source and the reflecting plane. (b) High frequency random sound is radiated fairly uniformly in all directions except those almost parallel to the reflecting plane. Microphone readings taken near the reflecting plane therefore tend to have low accuracy. This low accuracy zone shrinks with increasing frequency and band width. (c) At medium frequencies, the directivity pattern is very pronounced, even for random sound of one octave effective band width. (d) The "valleys" in the curves [of Figure 26] occur in regular intervals. At any given frequency and source location, low readings will be obtained at several microphone positions spaced in the ratio of 1:3:5:7 from the reflecting plane. Odd multiple spacings should therefore be avoided."

Figure 27 illustrates the errors in determining the total sound power from a random point source a distance h above a reflecting plane, when measurements are made in 1/3-octave band widths, for the microphone arrays indicated. The difference between the mean for each array (broken curves) and the true mean (solid curve) represents the error associated with the particular array.

One way to obtain essentially perfect vertical averaging is to traverse the microphone along a meridian as shown in Figure 28.

The curves shown in Figures 26 and 27 were calculated for the case of a point source above a perfectly reflecting plane. In general, increasing the source size will result in less variation of the sound pressure level with angle.

Other references relevant to the effect of the reflecting plane on the selection of appropriate microphone positions include [74-77].

Several recent investigations (e.g., [75, 5-7]) have found that rather accurate determinations of the total sound power emitted by real machines can be made using measurements of sound pressure level made quite close (0.3 to 1 m) to the source. Accordingly, a draft international standard[13] suggests two arrays of microphone positions to be used for such close-in determinations of sound power.

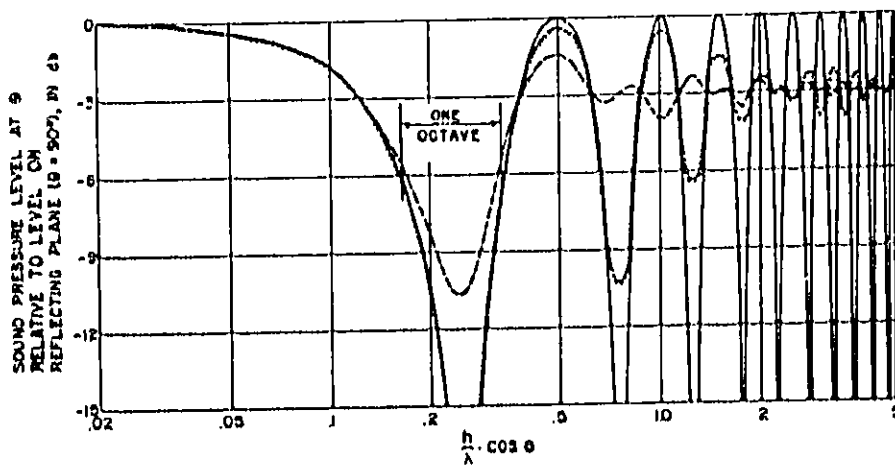

Figure 26. Effect of bandwidth on directivity of sound field of a point source at a distance, h , from a reflecting plane ($\lambda =$ wave length at center frequency of band)[73-74].

————— pure tone
 1/3 octave } effective band width
 - - - - - full octave }

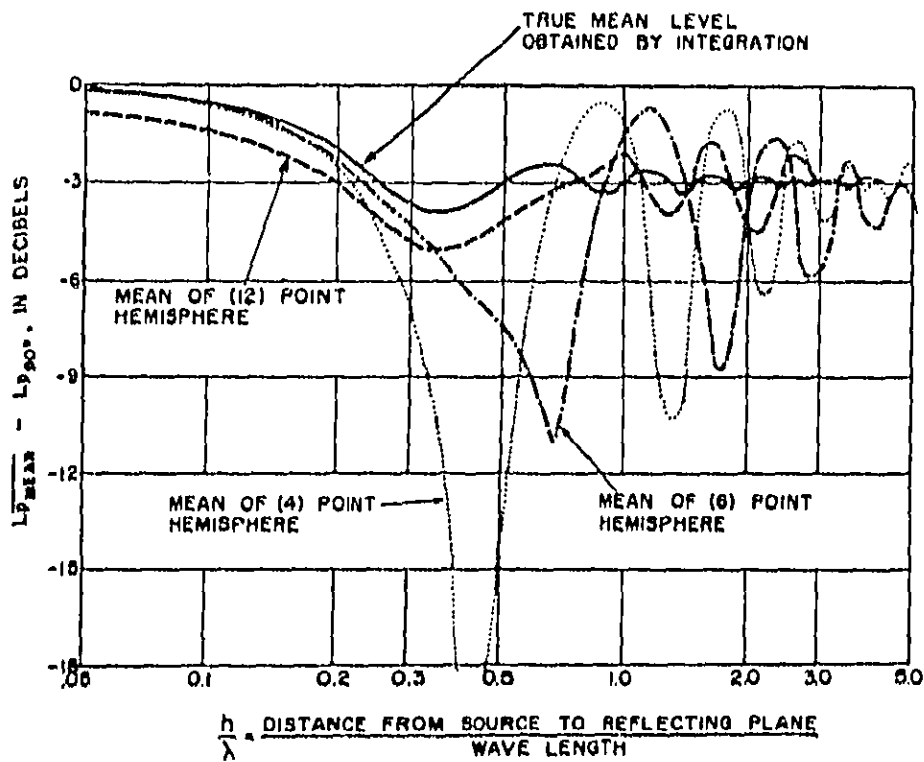

Figure 27. Error introduced by limited number of measuring points when determining sound power output of a random point source near a reflecting plane [73-74]. The error is the difference between the curve corresponding to a given microphone array and the solid curve which corresponds to the true mean level. All curves correspond to a 1/3-octave band width.

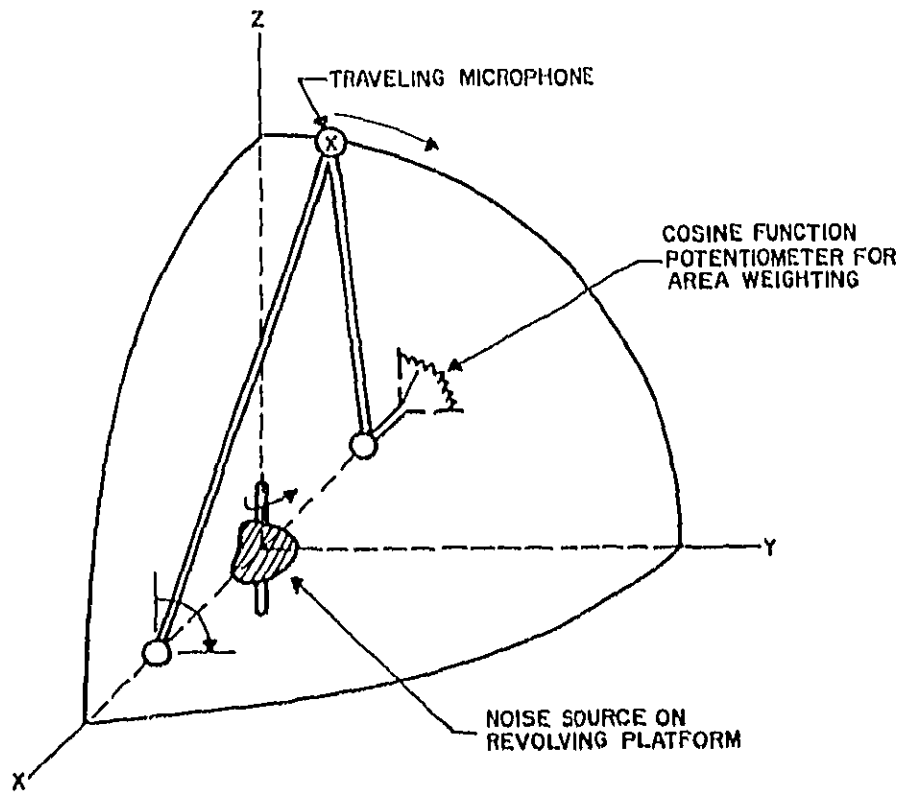

Figure 28. System for microphone traverses along meridional paths[14].

In the first of these, a "reference parallelepiped", as shown in Figure 29, is imagined to just enclose the source. A measurement surface is hypothesized to have its faces parallel to, and spaced a constant distance (typically 1 m) from, the reference parallelepiped. Nine key microphone locations are established, corresponding to the (approximate) centers of the five faces, plus the four upper corners, of the measurement surface. Procedures are given in [13] for adding additional microphone positions for large sources.

Figure 30 shows an example of the "composed measurement surface" given in [13]. It consists of a parallelepiped with rounded edges and corners so as to be everywhere equidistant from the reference parallelepiped which just encloses the source. There are eight key microphone positions, four on the side faces and four which usually lie on the upper curved edges of the measurement surface.

Holmer[7] has carried out extensive comparisons of data (on 17 portable air compressors) obtained using the surfaces of Figures 29 and 30 with data obtained using a 73-point hemispherical array of 7 m radius.

c. Reverberant Space

As stated at the beginning of Section 12.2.c, elementary reverberation room theory is based on geometrical acoustics, in which wave phenomena are neglected. If that assumption were true, a single microphone placed in the reverberant field would suffice. However, wave phenomena result in local variations in the sound pressure level, particularly for pure-tones. The question of how best to sample the sound field in a reverberant room has been the subject of active research over the past decade[79-103].

The sound power emitted from a source is related, as discussed in Section 12, to the sound pressure in the reverberant field averaged in space and time on a mean-square basis. In practice, a spatial averaging over a finite path length (using a traversing microphone) or over a fixed number of microphone positions leads only to an estimate of the true mean-square sound pressure. Theory shows that in order to have essentially independent samples of the sound field, microphones must be located at least (approximately) one-half wavelength apart at each frequency of interest. In addition, interference phenomena occur near reflecting surfaces so that microphones typically are not located within one-half wave length of any room boundary or diffuser. For a close-packed (hexagonal close-packed or face-centered cubic) array of microphones located one-half wavelength from each other and at least one-half wavelength from any wall, the number of microphones that can be accommodated is less than

$$N = 8\sqrt{2} \frac{V}{\lambda^3} = 8\sqrt{2} V \left(\frac{f}{c}\right)^3, \quad (84)$$

where V is the volume of the room and λ is the wavelength of sound of frequency f traveling at speed c . This upper limit is shown in Figure 31 as a function of frequency for rooms of different volumes. In practice the number of independent microphone positions which could be located in a reverberation room would usually be significantly less than this upper limit.

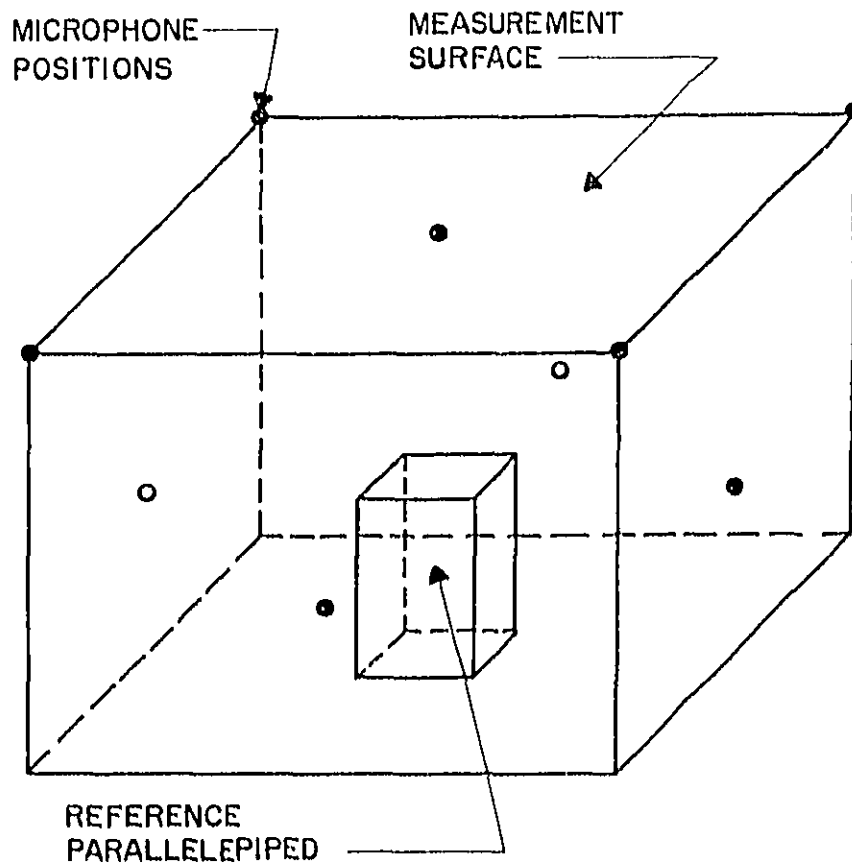

Figure 29. Microphone array for a parallelepiped measurement surface[13].

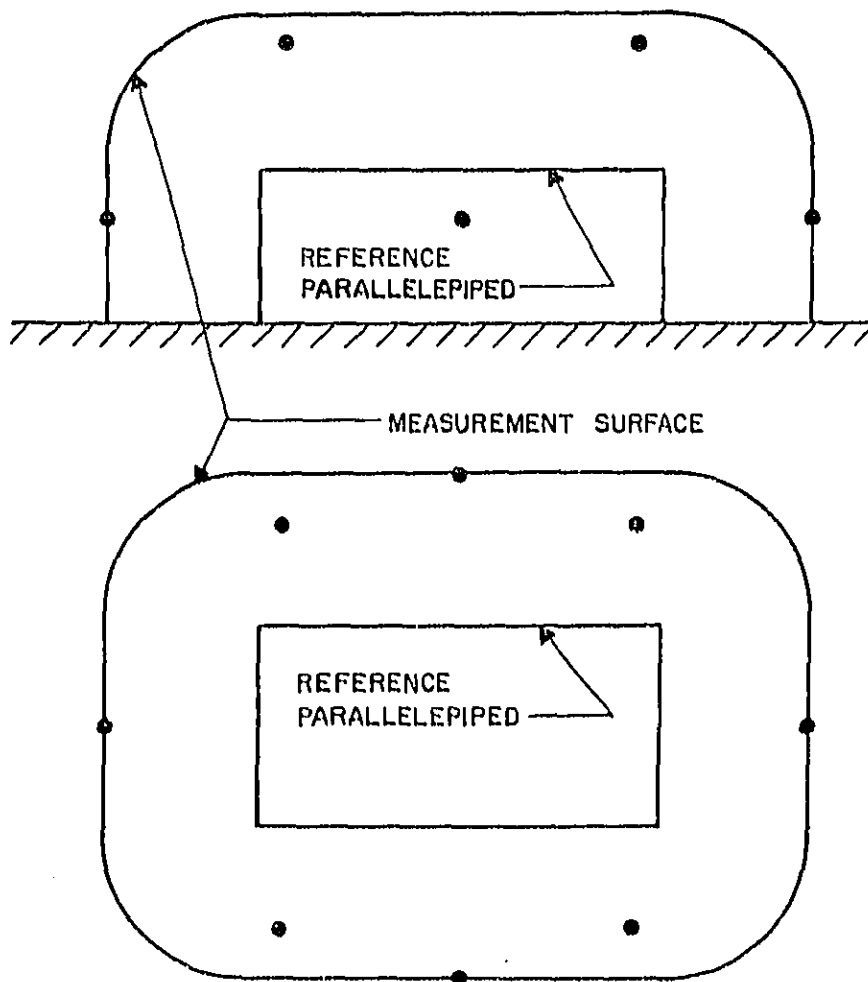

Figure 30. Microphone array for a "composed" measurement surface[13].

REST AVAIL ABN 5 0324

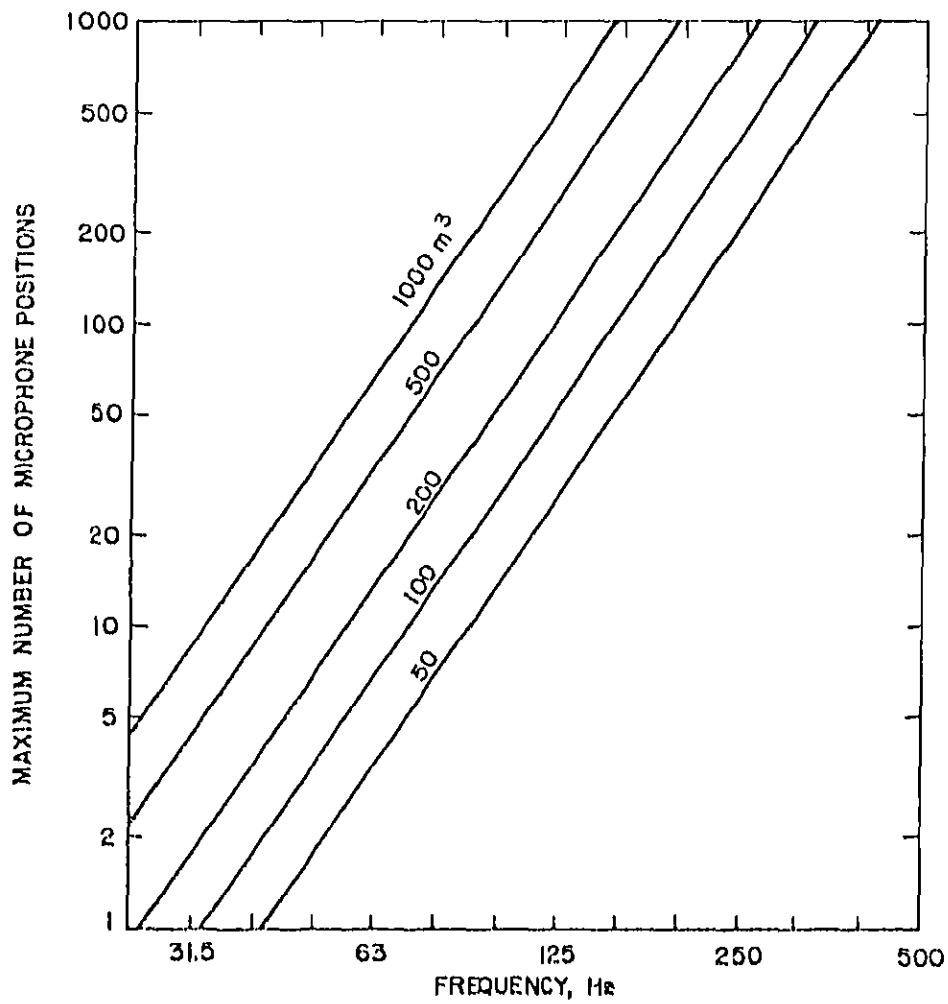

Figure 31. Upper limit on the number of microphone positions in rooms of the volumes shown if each position is at least a half-wavelength from all other positions.

When a reverberation room is excited by a random noise source, the normalized variance of the mean-square sound pressure in the room is given approximately by the following expression [84, 93, 100] provided the modal overlap is sufficiently great (e.g., see eq. (31)) and there are no moving diffusers in the room:

$$V^2 = \frac{2}{z} \arctan z - \frac{1}{z^2} \ln(1+z^2) \quad , \quad (85)$$

where $z = BT/2.2$, T being the reverberation time and B the bandwidth of the filter. For small values of z , eq. (85) becomes

$$V^2 = 1 - \frac{z^2}{2 \cdot 3} + \frac{z^4}{3 \cdot 5} - \frac{z^6}{4 \cdot 7} + \dots \quad , \quad (86)$$

so that $V^2 \rightarrow 1$ as $BT \rightarrow 0$. For large values of z , eq. (85) can be written as

$$V^2 = \frac{\pi}{z} - \frac{2}{z^2} (1 + \ln z) - \frac{1}{1 \cdot 3 \cdot z^4} + \frac{1}{2 \cdot 5 \cdot z^6} - \dots \quad , \quad (87a)$$

$$\approx \left[\frac{z}{\pi} + 0.8 \right]^{-1} = \left[\frac{BT}{6.91} + 0.8 \right]^{-1} \quad , \quad z \gg 1, \quad (87b)$$

so that $V^2 \rightarrow \pi/z \approx 6.91/BT$ as $z \gg 1$. The normalized variance, V^2 , computed from eq. (85), is shown in Figure 32. The spatial variance of the mean-square sound pressure decreases with an increase in the bandwidth of the noise signal since the number of modes excited in the room is approximately proportional to the bandwidth. As the reverberation time increases the amount of modal overlap decreases so that the effective number of independent samples in a given bandwidth increases. It should be emphasized that eq. (83) is only valid for modal overlap greater than about 3 so that if the reverberation time is too large, the behavior shown in Figure 32 can no longer be expected to be observed.

If N independent samples of the sound field are taken, the mean value of the (normalized) squared sound pressure is given approximately by $\bar{p}^2 = V^2/N$. The 95 percent confidence interval is given by $\pm e = \pm 1.96\sigma$. Thus the number of independent microphone positions required in order to have 95 percent confidence that the fractional error in the mean value of the squared pressure is less than $\pm e$ is

$$N \geq \left(\frac{1.96}{e} \right)^2 \frac{1}{V^2} \quad . \quad (88)$$

As an example of the use of eq. (88), let $e = 0.259$, corresponding to 95 percent confidence limits of ± 1 dB. Let $B = 23$ Hz (1/3-octave band centered at 100 Hz) and $T = 2$ s. Thus $z = BT/2.2 = 20.9$. From eq. (83) or Figure 32, $V^2 = 0.132$. Thus a value of N greater than $(1.96/0.259)^2 V^2 = 57.3 V^2 = 7.6$ is required.

Figure 33, which was generated using eq. (85) and (88), shows the minimum number of microphone positions needed in order to be 95 percent confident that for 1/3-octave bands of random noise, the spatial average of the mean-square sound pressure is known to within ± 1 dB. This number is shown as a function of

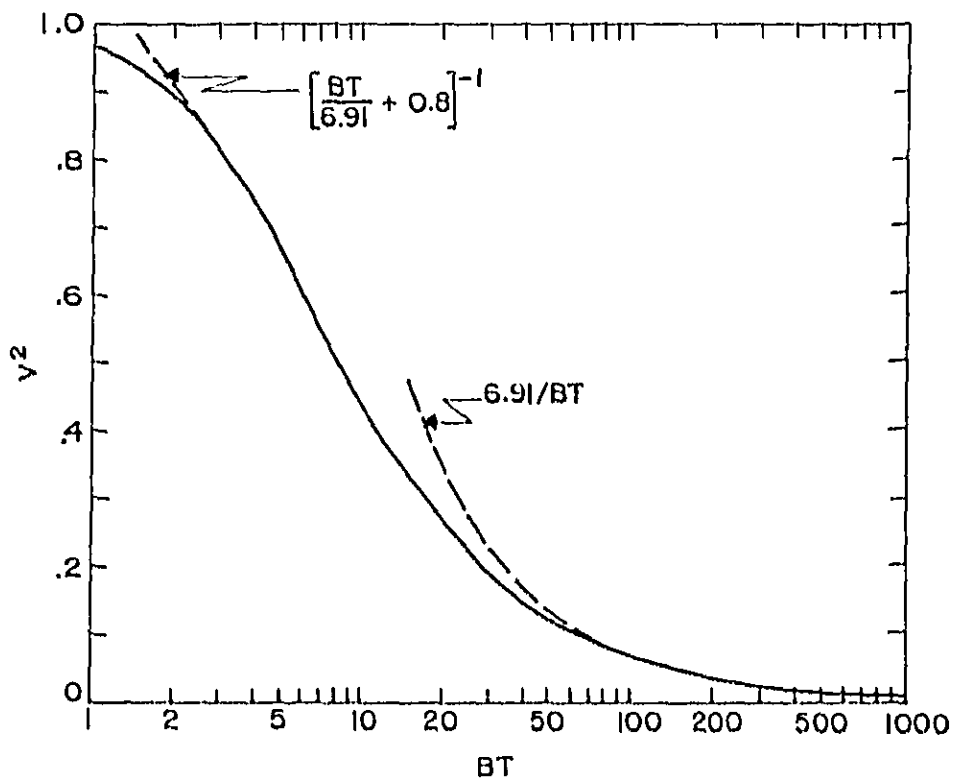

Figure 32. Normalized variance, $(\langle p^2 \rangle^2 - \langle p^2 \rangle^2) / \langle p^2 \rangle^2$, where $\langle \rangle$ denotes the average taken over all room locations, of the mean-squared sound pressure in a room having a reverberation time, T , and excited by random noise of bandwidth, B . The curve corresponds to eq. (85) which is valid for modal overlaps greater than about 3.

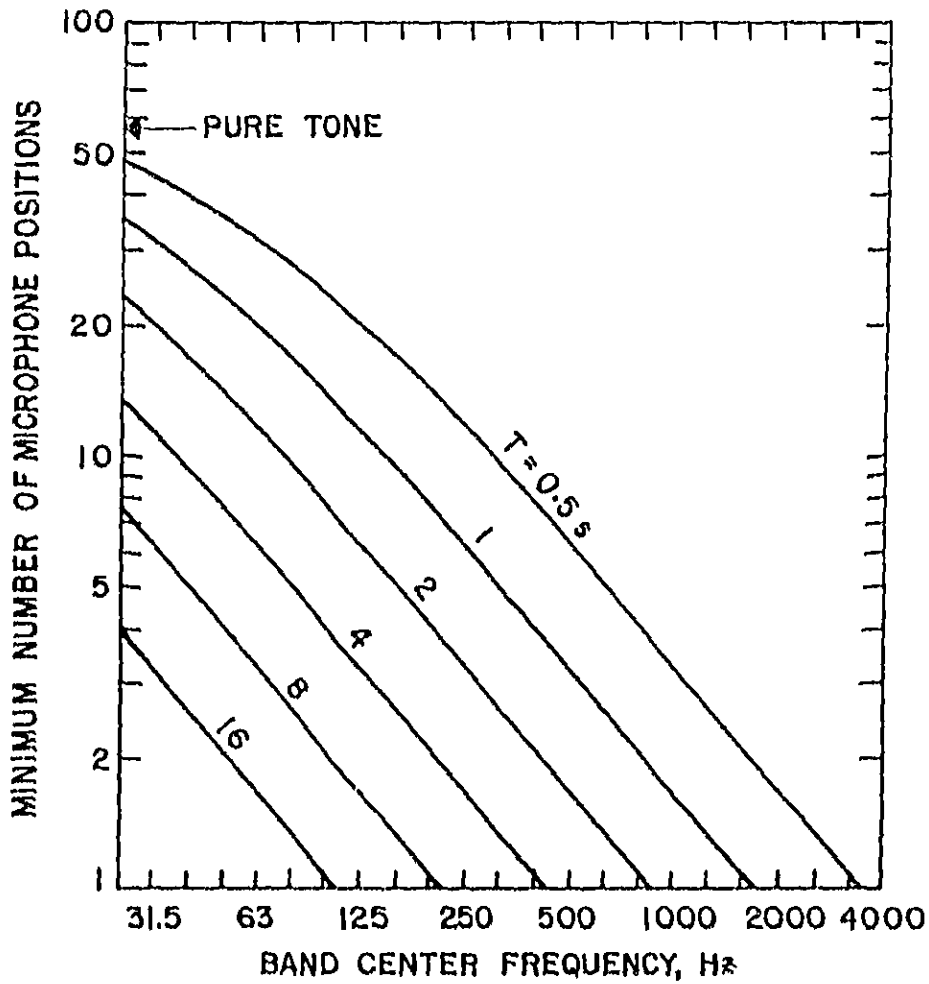

Figure 33. Minimum number of microphone positions needed for 1/3-octave bands of noise in order to have 95 percent confidence that the spatial average of the mean-square sound pressure is known within ± 1 dB.

frequency (utilizing the fact that the bandwidth of a standard 1/3-octave filter is equal to 0.232 times the center frequency, so that $\alpha = \pi T/9.5$) with reverberation time as a parameter. This figure may be used for other reverberation times simply by entering the abscissa at a numerical value equal to πT and reading the minimum number of microphone positions from the curve corresponding to $T = 1s$.

Suppose additional absorption had been added to a reverberation room, lowering the reverberation time from $4s$ to $1s$, in order to obtain a more uniform frequency response in the room. Assuming modal overlap were high enough in both cases for eq. (83) to be valid, it would be necessary to increase the number of microphone positions from 4 to 14 in order to still have 95 percent confidence that the average sound pressure level of a 1/3-octave band of noise was known within ± 1 dB. This example illustrates that once enough absorption has been added to achieve adequate modal overlap at the lowest frequency of interest, it is generally inadvisable to further reduce the reverberation time.

When a reverberation room is excited by a number of pure tones, the normalized variance of the mean-square sound pressure in the room, provided the modal overlap is sufficiently great and there are no moving diffusers in the room, is given approximately by [84, 93, 100]

$$v^2 = \left[\sum_{m=1}^M \Lambda_m \right]^{-2} \sum_{j=1}^M \sum_{k=1}^M \Lambda_j \Lambda_k \left\{ 1 + \left[\frac{(f_j - f_k)T}{2.2} \right]^2 \right\}^{-1} \quad (89)$$

where Λ_j (or Λ_k or Λ_m) is the mean-square sound pressure of the tone at frequency f_j (or f_k or f_m) and T is the reverberation time. In its complete form this expression is perhaps too complex to see easily the effects of the reverberation time and the spacing between tones. However, several special cases do yield considerable insight.

If the frequency separation, $f_j - f_k$, between tones is large compared to the modal bandwidth, $2.2/T$, only the terms for $j=k$ contribute significantly to the summations and eq. (89) reduces to

$$v^2 = \left[\sum_{m=1}^M \Lambda_m \right]^{-2} \sum_{m=1}^M \Lambda_m^2 = \frac{1}{M} \frac{\overline{\Lambda^2}}{(\bar{\Lambda})^2} \quad (90)$$

If, further, all the tones are of equal strength,

$$v^2 = \frac{1}{M} \quad (91)$$

Thus for well-separated tones of equal strength, the normalized variance of the mean-square sound pressure is simply equal to the reciprocal of the number of tones.

If the tones are of equal strength but are no longer well-separated, an

interesting special case is that where the M tones are uniformly separated by δf Hz. With this simplification, eq. (89) reduces to

$$v^2 = \frac{1}{M} \left\{ 1 + \frac{2}{M} \sum_{n=1}^{M-1} \frac{M-n}{1 + (nT\delta f/2.2)^2} \right\} \quad (92)$$

Figure 34 illustrates the variance, computed from eq. (92) as a function of the number of tones, with $T\delta f$, the product of the reverberation time and the tone spacing, as a parameter. It is seen that when $T\delta f$ is very small, so that the room responses to the several tones are highly correlated, the variance remains near unity, the value for a single tone, until M increases enough so that some of the tones are far enough apart in frequency to significantly reduce this correlation. When $T\delta f$ becomes large, the variance approaches $1/M$, the value for well-separated tones (eq. (91)). If the tones are not of equal strength, the variance will be greater than that indicated by eq. (92) and by Figure 34 but the effect of reverberation time will be approximately the same provided more than one tone contribute significantly to the overall mean-square sound pressure. It is again seen that the reverberation time should be as large as possible provided only that it is small enough to provide sufficient modal overlap in order that the reverberation room have a fairly uniform frequency response.

If the number, strength, and spacing of tones is known, the variance computed from one of eqs. (89) - (92) can be used in conjunction with eq. (88) to estimate the minimum number of microphones needed in order to determine the mean-square sound pressure within the desired confidence limits.

Equation (84) and Figure 31 indicated upper limits on the number of independent stationary microphone positions which can be accommodated in a reverberation room of a given volume. It is frequently more convenient to use a single microphone which is moved slowly over a particular path so as to sample the sound field at a number of positions. Since the sound field at one location can be highly correlated with the sound field at a nearby position, it is useful to consider the equivalent number of microphone positions corresponding to a given path. If a continuous linear microphone traverse over a path length L is used the equivalent number of independent microphone positions is [85-87, 91, 93]:

$$2L \cdot \frac{f}{c} < N_{eq} < 2L \cdot \frac{f}{c} + 1 \quad (93)$$

For a circular path of circumference L [93,96],

$$N_{eq} \approx \begin{cases} 1 & , 2L \cdot \frac{f}{c} < 1 \\ 2L \cdot \frac{f}{c} & , 2L \cdot \frac{f}{c} \geq 1 \end{cases} \quad (94)$$

At high frequencies, where adequate spatial sampling can readily be achieved, it may be easier to use a continuous traverse. At lower frequencies, a fixed array will usually enable more independent samples than can simply be obtained with a continuous traverse.

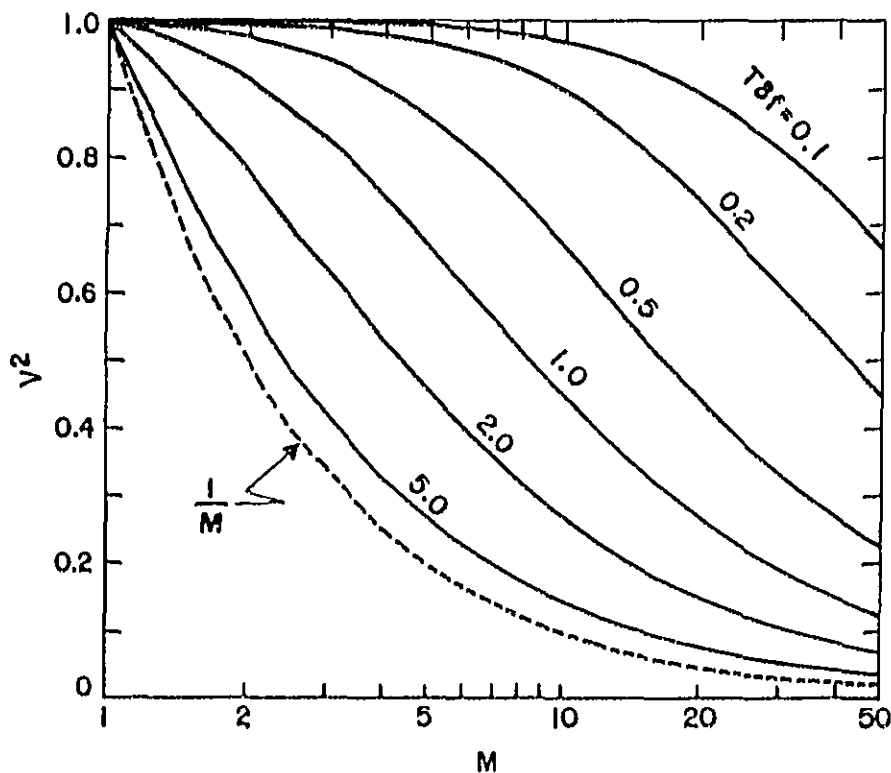

Figure 34. Normalized variance of the mean-squared sound pressure in a room, having a reverberation time, T , excited by M equal-strength pure tones uniformly separated in frequency by δf . The curves correspond to eq. (92) which is valid for modal overlaps greater than about 3.

The current national[29] and international[10] standards for determination of sound power in a reverberation room state that for broad-band sound sources, space averaging of the sound field shall be accomplished by one of the following two procedures:

- (1) Traversing a microphone at constant speed over a path at least 3 m in length while the signal is being averaged on a mean-square basis. The path may be a line, an arc as obtained by swinging the microphone, a circle, or some other geometric figure.
- (2) Using an array of at least three fixed microphones (or microphone positions) spaced at least $\lambda/2$ from each other, where λ is the wavelength of sound corresponding to the lowest frequency in the frequency range of interest. The outputs of the microphones shall be either scanned automatically and averaged on a mean-square basis by the indicating device, or the average shall be computed from the mean-square outputs of each individual microphone position.

A path length of 3 m for the traverse and three positions for the array are the minimum requirements. It may be necessary to use a more extensive microphone traverse or array, or use moving or stationary sound diffusers, or both, in order to meet the requirements of the standard.

For pure tones sources the national[29] and international[11] standards require the minimum number of independent microphone positions shown in the following table:

OCTAVE BAND CONTAINING DISCRETE FREQUENCY COMPONENT	THIRD-OCTAVE BAND CONTAINING DISCRETE FREQUENCY COMPONENT	MINIMUM NUMBER OF INDEPENDENT MICROPHONE POSITIONS
125 Hz	100 to 160 Hz	6
250 Hz	200 to 315 Hz	12
500 Hz	400 to 630 Hz	24
1000 Hz	800 to 1250 Hz	30
Above 1000 Hz	Above 1250 Hz	30

The corresponding approximate minimum path lengths, if a traversing microphone is used, follow from eqs. (91) or (92). These standards[10,29] also require that:

The microphone traverse or array shall be within that part of the test room where the reverberant sound field dominates and where the contribution of the direct field to the measured mean-square pressure is negligible. To ensure that the chosen microphone traverse or array is within the reverberant field, the following criteria shall be met:

- (1) The minimum distance between the sound source and the nearest microphone position shall not be less than

$$d_{\min} = 0.08 \sqrt{V/T}$$

where

V = volume of test room in cubic meters
T = reverberation time in seconds

- (2)

This criterion corresponds (see eq. (21)) to the total (direct and reverberant) sound field not being more than 1.8 dB above the reverberant sound field (i.e., the direct field is 3 dB below the reverberant field), provided the source is essentially omni-directional. If the source is directional, one should place the nearest microphone(s) still further from the source (see eq. (21)) to assure that the direct field is at least 3 dB below the reverberant field. Since typically only one or two of the several microphone positions would be close enough to the source to be affected by the direct field, the bias introduced is rather small (e.g., if only one of six microphones is biased upwards by 1.8 dB, the estimate of the average sound level will be biased upward by 0.3 dB; if more microphones are used, the bias would typically be less).

15.3. Source Position

The importance of selecting an appropriate source location, typical of normal operation, was mentioned in Section 14.1. In carrying out measurements under conditions of a free field, or a free field over a reflecting plane, there are no additional measurement procedures specifically concerned with source position.

The current national[29] and international[11] standards for determination of sound power in a reverberation chamber give an empirical formula for calculating the recommended number of source locations when the source produces pure tones (see also [97]). This number depends on the reverberation time and volume of the room and on the frequency of the tone(s). The use of multiple source positions reduces the error due to low modal density because the extent to which a given mode is excited depends on the source position[104]. "The error due to incomplete space averaging is reduced because the total number of samples of the sound field is the product of the number of microphone positions used for each source position times the number of the source positions"[29].

15.4. Period of Observation

If the sound level at any given microphone position is steady, the required sampling time follows directly from considerations such as those discussed in Sec. 13. In carrying out measurements of the noise emitted from a particular source, several factors can cause the sound level at a given location to vary:

1. The noise emission from the source may be inherently variable as a function of changes in some operating parameter (e.g., speed, load, normal operating cycle).
2. There may be changes in the environment through which the sound propagates. These could include wind, air turbulence, temperature gradients, etc.
3. Some aspect of the measurement process may vary the sound level. Typical examples would be motion of the microphone relative to the source or modulation of the sound field in a reverberation room by a moving diffuser.

In case 1, it is necessary to decide whether one is interested in the noise emission during one or more specific portions of an operating cycle or whether one is interested in an appropriate average over a complete operating cycle. Once this decision has been made, the appropriate period of observation follows rather easily.

In case 2, one is probably in trouble if the situation arises and hence one should seek a more favorable environment. However, if that is not possible, sufficient independent data points should be taken to permit averaging out statistical variations.

In case 3, two situations merit specific mention. If a source is being rotated in an anechoic (or hemi-anechoic) environment (or if a microphone is being moved around the source) it is important that the motion be slow enough to permit valid sampling. This is particularly important for highly directional sources and for sources which produce random noise. If sound power determinations are being made in a reverberation chamber it is very common to use a moving microphone and/or a moving diffuser. The national[29] and international[10, 11] standards provide guidance on the appropriate period of observation.

15.5. Use of Diffusers

It has been customary for many years to use fixed and/or moving "diffusers" to affect the accuracy and precision of sound measurements carried out in reverberation rooms. Dold and Doak[105] have pointed out the reasons why stationary diffusers are probably rather ineffective in improving reverberation room determinations of sound power:

"Also, it is perfectly clear that, whatever else they may do to affect sound pressure level distributions in reverberant rooms, fixed diffusers in no way reduce, or otherwise affect, the statistical spatial and frequency fluctuations in sound pressure level described above. Thus use of fixed diffusers will not, in general, reduce the amount of frequency and space averaging required to give unambiguous measurements. Fixed diffusers could, in theory, reduce eigenfrequency degeneracy and also eigenfunction degeneracy (i.e., the tendency of eigenfunctions in geometrically simple rooms to fall into classes having maxima or minima at particular points). As, however, reverberant rooms are seldom constructed in the shapes of perfect spheres, cylinders, or cubes, and also because when used in practical measurements they usually contain at least one scattering object, it would appear that use of fixed diffusers contributes much more to optical aesthetics than it does to acoustics. Of course, there is one notable exception to this remark. When relatively large areas of absorbing material are placed in reverberation rooms for absorption coefficient measurements -- on the floor, for example -- the reverberant field may no longer be directionally isotropic. In this case, it is possible that suitable fixed diffusers can restore a measure of directional isotropy to the field in the neighbourhood of the area of the absorbent material."

On the other hand, it has been well established that moving diffusers can very significantly improve the determination of the average steady-state sound pressure level in a reverberation room. Consider first the situation where a diffuser is incrementally moved through a range of stationary orientations. Each change in orientation can result in a perturbation of the standing wave pattern in the room, with both the eigenfrequencies and the eigenfunctions being somewhat changed. In addition, as shown by Ebbing[106], the radiation impedance seen by the source will vary with diffuser orientation so that the actual sound power radiated by the source also will vary. Thus, even when a diffuser is moved very slowly, the various orientations of the diffuser lead to an improved average for the mean-square sound pressure in the room.

When the diffuser is moved more rapidly, there is both amplitude and frequency modulation of the sound field[107-110, 93, 97-100] with the result that the sound energy from a pure tone is converted into a number of tones -- as seen in Section 15.2, the spatial variance due to a multitone can be much less than that due to a single tone. In addition, the rotation of the diffuser does not permit modes to build up to the full strength they could have if the diffuser were stationary.

While the design of moving diffusers remains somewhat of an art, it is recognized[110] that the major design parameters are size, shape, percent open area, surface density, speed, number of panels, and panel damping. A few general guidelines for the design of rotating diffusers are given in current standards[29,11].

15.6. Background Noise Measurements

A general discussion of criteria for background noise was given in Section 12.3. It is important to assure that the background noise in the same

when it is measured as it is when the source is operated. If corrections for background noise are to be made, additional measurements may be necessary to ascertain whether or not there is coherence between the source noise and the background noise.

Peterson[11] has recently examined the uncertainties which may occur in the background noise correction when the device noise and the background noise are both random in character.

15.7. Characterization of Test Environment

Section 12.2 includes discussions of the adequacy of various types of test environment. In the present section, a brief summary is given of the means for characterizing the test environment which are spelled out in current standards.

a. Anechoic Chamber

The current draft international standard[14] for precision determinations of sound power in anechoic rooms requires measuring the change of sound level with distance along at least eight straight paths away from the center of an omnidirectional sound source which is radiating a pure tone. The range of distances and frequencies for which the measured sound levels agree, within specified tolerances, with levels predicted by the inverse square law define the usable volume and frequency range for the anechoic chamber.

b. Hemi-Anechoic Environment

The current draft international standard[14] for precision determinations of sound power in hemi-anechoic rooms utilizes the qualification procedure just described but allows larger deviations than in the case of anechoic chambers. No corrections are permitted for the influence of the test environment.

The current draft international standard[13] for engineering methods of determining sound power under free-field conditions over a reflecting plane permits making a correction of up to 2 dB for the influence of the test environment. Three alternative methods are given for qualifying the acoustic environment and determining the "environmental correction":

1. Replace the device whose sound power level is being determined with a reference sound source of known sound power output. The environmental correction is then taken as the difference between the known power level and the power level computed using the procedures of the standard.
2. Replace the device whose sound power level is being determined with a broad band test source (of unknown power output). Determinations

of the sound power of this test source are made using three measurement surfaces of similar shape but different size. The environmental correction is obtained from the differences among the three sound power levels obtained in this manner.

3. Compute the environmental correction from measurements of the reverberation time of the test room.

The current draft international survey method[15] for determination of sound power levels permits environmental corrections of up to 7 dB based on the absorption (estimated or computed from the reverberation time) of the test room.

The above-described procedures are based mainly on the work of Hübner[5-6]. Diehl[112-113] has investigated determination of environmental corrections by the "two-surface method" in which two measurement surfaces of different area are utilized with the actual device under investigation (rather than a special test source).

Hübner[6] has pointed out that none of the above procedures for determining environmental corrections can account for the influence of the acoustic impedance of the reflecting plane. The draft international standards[13-14] for sound power determination simply require that "the absorption coefficient of the plane should be less than 0.06 over the frequency range of interest." In the case of outdoor measurements, whether of sound power level or of sound pressure level at a specified location, it may be difficult to ensure that the absorption is as low as desired. At test sites for measuring motor vehicle noise emission, very large differences have been observed between the acoustical absorption of sealed and unsealed asphalt[114]. The flatness of reflecting surfaces can also lead to problems[115]. Statistically significant differences have been observed among results obtained at various test sites[116]. While there has been progress in developing means to correct for the effects of the reflecting plane (e.g., see [76-78]), much further work is needed. At present it appears that dense concrete, sealed asphalt, or a material at least equally dense and free from porosity should be specified for the reflecting plane.

c. Reverberant Environment

The current national and international standards for reverberation-room determinations of both broad-band[10, 29] and pure-tone[11, 29] sources give specific room qualification procedures.

In the case of broad-band sound, determinations of the apparent sound power level of a reference sound source are carried out for at least eight different source locations. In order for the room to be qualified, the standard deviations of this set of band power levels must not exceed the limits tabulated (as a function of frequency).

In the case of sources containing discrete-frequency components, two alternative qualification procedures are given. In the first of these, an

array of six microphone positions is used to estimate the spatial variance of the mean-square pressure in the room while the device under test is emitting noise. This information is used to enter a table which gives the minimum number of required microphone procedures. Procedures are also given for determining the minimum number of required source positions.

The second qualification procedure for the measurement of discrete frequency components involves measuring the frequency response of the reverberation room. This is done by measuring the space/time averaged sound pressure level at each of a specified series of frequencies. A loudspeaker, excited by an oscillator, is used and adjustments are made for the frequency response of the loudspeaker and measuring instrumentation. The apparent standard deviation of the frequency response over each frequency band must not exceed a tabulated limit.

15.8. Calibration

A measurement standard should specify what calibration procedures are required in conjunction with normal testing procedures and also what calibration procedures are required (e.g., annually) in order to ensure proper functioning of all instrumentation.

16. Calculation Procedures

- *The measurement standard should clearly and unambiguously specify all calculation procedures that are required in order to carry out measurements in accordance with the standard.*

16.1. Correction for Background Noise

Corrections for background noise were discussed in Sections 12.3 and 15.6. A measurement standard should clearly indicate how much background noise is permissible and whether or not corrections for background noise are to be made. If corrections are to be made, the standard should clearly spell out the correction procedure to be used.

Consider the following differences in the approach to background noise corrections as taken in the current (draft and approved) international standards for sound power determination:

- Precision methods for anechoic and semi-anechoic rooms[14]

The background noise must be at least 6 dB below the measured sound pressure levels. For background noise between 6 and 15 dB down, the corrections given in Table 3 (Section 12.3) are to be applied. The corrections are rounded to the nearest 0.1 dB.

- Precision methods in reverberation rooms[10,11]

Same as above except no corrections are applied when the background noise is more than 10 dB down. (This reflects the greater uncertainty in reverberation room measurements.)

- Engineering methods for free-field conditions over a reflecting plane[13]

For background noise that is 6 to 8 dB down, a 1.0 dB correction is applied. For background noise that is 9 to 10 dB down, a 0.5 dB correction is applied.

- Engineering methods for special reverberation test rooms[12]

For background noise that is 4 to 5 dB down, a 2 dB correction is applied. For background noise that is 6 to 9 dB down, a 1 dB correction is applied.

- Survey method (free-field conditions over a reflecting plane)[15]

For background noise which is 3 dB down, a 3 dB correction is applied. Otherwise, same as previous standard[12].

Many standards require the background noise to be at least 10 dB down and permit no correction.

16.2. Correction for Test Environment

A measurement standard should clearly delineate what corrections, if any, are to be made for the influence of such factors as:

- test room
- reflecting planes(α)
- temperature and barometric pressure
- wind

16.3. Determination of Mean-Square Pressure

A measurement standard should specify how individual determinations of sound pressure level are to be combined in order to obtain the appropriate average value for the mean-square pressure or the sound pressure level. This involves both time and spatial averaging.

Some standards permit averaging of levels, rather than of mean-square pressure, when the range of levels is not too large. If such is the case, the allowable range should be indicated.

16.4. Calculation of Sound Power

A measurement standard should present explicit equations for calculating sound power level for the measured data.

16.5. Calculation of Noise Rating

If the final data (sound pressure level or sound power level as a function of frequency) are to be used to compute a single-figure rating that is intended to correlate with subjective response, the computation procedure should be clearly and unambiguously given. For example, a procedure which involves application of a "pure tone penalty" should specify quantitatively how the presence and magnitude of the pure tone is to be determined.

If other documents are to be referenced, the particular issues and relevant portions of those documents should be indicated.

16.6. Calculation of Measurement Uncertainty

"Examination of noise literature reveals a general absence of estimates of uncertainties associated with measurement or predictive procedures or with actual measured data. Even when such estimates are given, they frequently are ambiguous or inadequate.

"In noise control engineering, there has been little opportunity for

direct comparison of data obtained by different investigators on nominally identical specimens. Thus, there have been few direct indications of experimental error. Furthermore, in view of the vagaries of human response, it has been probably justifiable to take the attitude that a "few decibels" are not of much consequence. Perhaps for these reasons, the use of uncertainty estimates has not evolved in noise control engineering.

"The emergence of many new and pending noise regulations has changed this situation drastically. Enforcement of these regulations requires manufacturers, independent laboratories, and regulatory agencies to conduct measurement on similar specimens. The requirement that all of them obtain essentially the same answer creates a strong need for realistic, reliable estimates of measurement uncertainty throughout the field of noise control engineering. Measurement uncertainties must be known not only to enforce equitably noise regulations but also to enable rational selection of economical noise control solutions and to enable reliable monitoring of the noise environment." [117]

Although little work has been done in the past toward assessment of the uncertainty (see Appendix C for a discussion) of noise measurements, efforts should be made in future measurement standards to incorporate specific calculation procedures for estimating the uncertainty of the final number emerging from a noise measurement procedure.

17. Information to Be Recorded

The measurement standard should require the following essential items to be recorded:

- The size, dimensions, design characteristics and noise performance claims for the source under test.
- The location, mounting and/or installation details of the source.
- The operational and loading characteristics of the source during the test.
- A description of the acoustic environment including test facility, background noise levels and environmental conditions.
- Identification of instrumentation utilized.
- Documentation of unavoidable deviations from the prescribed test procedures.
- A maintenance and calibration record to indicate the current calibration status of all instrumentation. Calibration methods and periodicity, accuracy and traceability of the calibration devices need to be detailed.
- All significant data collected during the test.
- Documentation of calculation procedures utilized in transforming the raw data into its final form.
- An indication of the accuracy and precision of the data.

17.1. Sound Source Under Test

A complete description of the test specimen should be recorded. This should include:

- (1) Size and dimensions of specimen
- (2) Detailed design and construction characteristics
- (3) Expected performance requirements (manufacturer's claims).

17.2. Sound Source Installation Details

A detailed description or a photograph of the noise source as it is normally installed for use should be included. Following this, a description should be given of:

- (1) Location of source
- (2) How source is mounted
- (3) Installation of source

Insofar as possible, the test installation should be representative of normal use conditions.

17.3. Sound Source Operating Procedures

The information to be included under sound source operating procedures is:

- (1) Auxiliary equipment used to power the source (if any)
- (2) How the source was operated during the test
- (3) What loading, if any, was applied during the test.

A copy of the operating instructions for the noise source should be made part of the record.

17.4. Acoustic Environment

Information on the acoustic environment should include a detailed description of the test facility or site, the nature and levels of any background noise, and temperature, humidity, barometric pressure and wind conditions (as pertinent).

17.5. Instrumentation

A complete list of the instrumentation utilized when conducting the tests should be recorded, including the following:

- (1) Name of instrument
- (2) Manufacturer
- (3) Model Number
- (4) Serial Number

In addition, for each sophisticated test device there should be a schematic, parts list, technical description of operation, a complete accuracy statement (absolute error, repeatability, effect of environmental and operational factors, etc.), and a maintenance and calibration schedule (note that, for purchased equipment, most or all of this information may be supplied by the manufacturer or vendor). The information noted above should be readily available on request.

BEST AVAILABLE COPY

17.6. Special Measurement Procedures

Any deviations from the standard method of test, or any additional tests which are conducted should be carefully recorded.

17.7. Calibration History

For each instrument a fully implemented calibration procedure should prescribe the method and periodicity of calibration and the accuracy and traceability of calibration devices used. All instruments should be assigned an exclusive identification number and complete records maintained to indicate current calibration status at all times. On key instrumentation, labels should be affixed to indicate status and next required calibration. In addition, the calibration procedures utilized before and after each test should be detailed, and the results of test environment qualification checks should be referenced.

17.8. Acoustical Data and Related Information

All significant data collected during the tests should be recorded. Also, variable settings on the equipment which have an influence on the data should be noted (for example, gain setting on a measuring amplifier, voltage and speed settings on recorders, etc.).

17.9. Special Calculation Procedures

If any special procedures are used to convert the data to some other measure (for example, converting sound pressure level readings to sound power, voltage readings to sound pressure level readings), these should be documented.

17.10 Measurement Uncertainty

An indication of the measurement uncertainty should be calculated from the data (see Appendix C).

18. Information to Be Reported

The measurement standard should require that the following essential items be reported:

- A complete description of the product tested.
- A detailed description of (1) the acoustic environment in which the tests are carried out and (2) how the device is operated under test. Detailed diagrams should be utilized where appropriate.
- When unavoidable deviations from the prescribed measurement procedures are necessary, a description of the substituted procedures and a justification for the modification.
- A tabulation of the acoustical data in its final form plus the notation of any factor which is thought to have influenced the data.
- A statement of measurement uncertainty including (1) the degree of confidence placed on the measurement results and (2) an indication of the representativeness of the sample tested.

Not every test report would include exactly the same information. To make it a requirement that each test report contain information on X number of attributes would not only be wasteful and unnecessary, but also detrimental to the whole testing process. In general, however, there are five areas where information should always appear in a test report -- these are briefly described below.

18.1. Identification of Source

The test report should contain a complete description of the product which was tested. Information to be included would be the manufacturer's name and address, model and serial numbers of the product, a description (and if appropriate, a diagram) of the appearance of the device, its conventional operating characteristics, and the performance claims of the manufacturer which relate to noise.

18.2. Source Installation and Operating Procedure

A detailed description, with diagrams where appropriate, of the acoustic environment in which the tests are carried out should be included in the report. As part of this description, the location of the sound source in the test environment, its mounting configuration, and its spatial relationship to the measuring system should be discussed. A description of how the device is operated under test is an essential part of the report. If the device is operated in any manner other than its conventional operating mode, this

operating procedure should be completely described.

18.3. Deviations from Standard Measurement Procedures

When there are no deviations from the standard measurement procedure, it is sufficient in the test report to merely cite the measurement procedure employed. If there are deviations from the measurement procedure, the following information should be included in the test report:

- (1) The section(s) of the standard test method which has (have) been deviated from.
- (2) A complete description of the method and procedures which have been substituted.
- (3) A convincing justification of why the standard measurement method was not followed.
- (4) An estimate of the uncertainty due to deviations from standard measurement procedures.

18.4. Acoustical Data and Related Information

A tabulation of the acoustical data in its final form (that is, if any conversion factors have been applied to the original data) should appear in the test report. If there are any factors, such as relative humidity, barometric pressure, wind speed and temperature, which the investigator believes may have influenced the data, these should be accounted for in the test report.

18.5. Measurement Uncertainty

The section on measurement uncertainty should include two parts. First, there should be some indicator of the degree of confidence which can be placed in the measurement results. This could be expressed in terms of standard error, confidence limits, or some other appropriate statistical factor. Secondly, there should be some statement that indicates how confident the testing laboratory is that the sample it has chosen and tested is representative of the product line. Again, this should be stated statistically. If a number of supposedly identical products were tested, the standard error and the range should be reported and an attempt made to estimate how much of the variance is due to sample differences and how much to measurement uncertainties.

References for Part II

- [1] The International System of Units (SI), NBS Special Publication 330, 1974 Edition.
- [2] Some References on Metric Information, NBS Special Publication 389 (1973).
- [3] Mechtly, E. A., The International System of Units -- Physical Constants and Conversion Factors (Revised), NASA SP-7012 (National Aeronautics and Space Administration, Washington, D. C., 1970).
- [4] Lang, W. W., and Flynn, D. R., A Noise Emission Number for product designation, Noise Control Engineering 4, 108-113 (1975); errata in NCE 5, 3 (1975).
- [5] Hübner, G., Analysis of errors in measuring machine noise under free-field conditions, J. Acoust. Soc. Amer. 54, 967-977 (1973).
- [6] Hübner, G., and Meurers, H., Investigations of sound propagation over non-ideal reflecting planes and the influence of the measurement distance on the accuracy of sound power determination of sound sources operating outdoors, Proceedings of Le Bruit des Machines et L'Environnement, Premier Congrès Européen d'Acoustique, F.A.S.E. 75, pp. 559-567 (Paris, 1975).
- [7] Holmer, C. I., Procedures for Estimating Sound Power from Measurements of Sound Pressure: An Experimental Investigation with Application to Noise from Portable Air Compressors, NBSIR 75-652, EPA-550/8-76-001 (National Bureau of Standards, July, 1975). Available from the National Technical Information Service, Springfield, Va. 22151, as Accession No. COM-75-11399.
- [8] American National Standard Methods for the Measurement of Sound Pressure Levels, S1.13-1971 (American National Standards Institute, New York, 1971).
- [9] Acoustics -- Determination of Sound Power Levels of Noise Sources -- Guidelines for the Use of Basic International Standards and for the Preparation of Noise Test Codes, Draft International Standard ISO/DIS 3740 (International Organization for Standardization, Geneva, 1975).
- [10] Acoustics -- Determination of Sound Power Levels of Noise Sources -- Precision Methods for Broad-Band Sources in Reverberation Rooms, International Standard ISO/3741 (International Organization for Standardization, Geneva, 1975).
- [11] Acoustics -- Determination of Sound Power Levels of Noise Sources -- Precision Methods for Discrete-Frequency and Narrow-Band Sources in Reverberation Rooms, International Standard ISO/3742 (International Organization for Standardization, Geneva, 1975).

BEST AVAILABLE COPY

- [12] Acoustics -- Determination of Sound Power Levels of Noise Sources -- Engineering Methods for Reverberation Rooms, Draft International Standard ISO/DIS 3743 (International Organization for Standardization, Geneva, 1975).
- [13] Acoustics -- Determination of Sound Power Levels of Noise Sources -- Engineering Methods for Free-Field Conditions over a Reflecting Plane, Draft International Standard ISO/DIS 3744 (International Organization for Standardization, Geneva, 1975).
- [14] ISO 3745, Acoustics -- Determination of Sound Power Levels of Noise Sources -- Precision Methods for Anechoic and Semi-Anechoic Rooms, Draft International Standard ISO/DIS 3745 (International Organization for Standardization, Geneva, 1975).
- [15] Acoustics -- Determination of Sound Power Levels of Noise Sources -- Survey Method, Draft International Standard ISO/DIS 3746 (International Organization for Standardization, Geneva, 1975).
- [16] Delany, M. E., and Bazley, E. N., Monopole radiation in the presence of an absorbing plane, *J. Sound Vib.* 13, 269-279 (1970).
- [17] Van Moorhem, W. K., Reflection of a spherical wave from a plane surface, *J. Sound Vib.* 42, 201-208 (1975).
- [18] Beranek, L. L., and Sleeper, H. P., The design and construction of anechoic sound chambers, *J. Acoust. Soc. Amer.* 18, 140-150 (1946).
- [19] Meyer, E., Kurtze, G., Severin, H., and Tamm, K., Ein neuer grosser reflexionsfreier Raum für Schallwellen und kurze elektromagnetische Wellen, *Acustica* 3, 410-420 (1953).
- [20] Ingeraley, F., Pedersen, O. J., Møller, P.K., and Kristensen, J., New rooms for acoustic measurements at the Danish Technical University, *Acustica* 12, 185-199 (1967-68).
- [21] Diestel, H.G., Messung des mittleren Reflexionsfaktors der Wandauskleidung in einem reflexionsarmen Raum, *Acustica* 20, 99-104 (1968).
- [22] Delany, M. E., and Bazley, E. N., A note on the sound field due to a point source inside an absorbent-lined enclosure, *J. Sound Vib.* 14, 151-157 (1971).
- [23] Parkin, P. H., and Stacy, E. F., The anechoic and reverberant rooms at the Building Research Station, *J. Sound Vib.* 19, 277-286 (1971).
- [24] Davern, W. A., A design criterion for sound-absorbent lining of an anechoic chamber, *Appl. Acoust.* 2, 69-71 (1972).

- [25] Koidan, W., Hruska, G. R., and Pickett, M. A., Wedge design for National Bureau of Standards anechoic chamber, *J. Acoust. Soc. Amer.* 52, 1071-1076 (1972).
- [26] Bell, E. C., Hulley, L. H., and Mazunder, N. C., The steady-state evaluation of small anechoic chambers, *Appl. Acoust.* 6, 91-109 (1973).
- [27] Standard Method of Test for Impedance and Absorption of Acoustical Materials by the Tube Method, C384-58 (1972), pp 115-126, Part 18, 1975 Annual Book of ASTM Standards (American Society for Testing and Materials, Philadelphia, 1975).
- [28] Beranek, L. L., *Acoustics* (McGraw-Hill Book Company, New York, 1954).
- [29] American National Standard Methods for the Determination of Sound Power Levels of Small Sources in Reverberation Rooms, S1.21-1972 (American National Standards Institute, New York, 1972).
- [30] Morse, P. M., and Bolt, R. H., Sound waves in rooms, *Rev. Mod. Phys.* 16(2), 69-150 (1944).
- [31] Morse, P. M., *Vibration and Sound*, Second Edition (McGraw-Hill Book Company, New York, 1948).
- [32] Morse, P.M., and Ingard, K. U., *Theoretical Acoustics* (McGraw-Hill Book Company, New York, 1968).
- [33] Beranek, L. L., *Noise and Vibration Control* (McGraw-Hill Book Company, New York, 1971).
- [34] Kuttruff, H., *Room Acoustics* (John Wiley & Sons, New York, 1973).
- [35] Crocker, M. J., and Price, A. J., *Noise and Noise Control*, Vol. I (CRC Press, Cleveland, 1975).
- [36] Magrab, E. B., *Environmental Noise Control* (John Wiley & Sons, New York, 1975).
- [37] American National Standard Specification for Sound Level Meters, S1.4-1971 (American National Standards Institute, New York, 1971).
- [38] Standard Values of Atmospheric Absorption as a Function of Temperature and Humidity, SAE Aerospace Recommended Practice ARP-866A (Society of Automotive Engineers, Warrendale, Pa., 1975).
- [39] Sutherland, L. C., Review of Experimental Data in Support of a Proposed New Method for Computing Atmospheric Absorption Losses, DOT-TST-75-87 (U.S. Department of Transportation, Office of Noise Abatement, Washington, D.C. 20590, May, 1975).

- [40] American National Standard Specifications for Laboratory Standard Microphones, S1.12-1967 (American National Standards Institute, New York, 1967).
- [41] American National Standard Method for the Calibration of Microphones, S1.10-1966 (American National Standards Institute, New York, 1966).
- [42] Recommendations for Sound Level Meters, IEC Publication 123 (International Electrotechnical Commission, Geneva, 1961).
- [43] Precision Sound Level Meters, IEC Publication 179 (International Electrotechnical Commission, Geneva, 1965).
- [44] Octave, Half-Octave, and Third-Octave Band Filters Intended for the Analysis of Sounds and Vibrations, IEC Publication 225 (International Electrotechnical Commission, Geneva, 1966).
- [45] American National Standard Specification for Octave, Half-Octave, and Third-Octave Band Filter Sets, S1.11-1966 (R1971) (American National Standards Institute, New York, 1966).
- [46] Magrab, E. B., and Blomquist, D. S., The Measurement of Time-Varying Phenomena (Wiley-Interscience, New York, 1971).
- [47] Bendat, J. S., and Piersol, A. G., Random Data: Analysis and Measurement Procedures (Wiley-Interscience, New York, 1971).
- [48] Donovan, J., and Ketcham, T., Transportation noise -- Its measurement and evaluation, Sound and Vibration 7(10), 4-8 (October 1973).
- [49] Olesen, H. P., and Zaveri, K., Measurements of averaging times of Level Recorders Types 2305 and 2307, Brüel and Kjaer Technical Review No. 1 - 1974.
- [50] Leasure, W. A., Jr., and Mathews, D. E., Pecos Truck Tire Noise Study: A Summary of Results, NBSIR 74-446 (National Bureau of Standards, Washington, D. C., 1974).
- [51] Standard Methods for Testing for Sound Rating Heating, Refrigerating, and Air-Conditioning Equipment, ASHRAE Std. 36-72 (American Society for Heating, Refrigerating and Air-Conditioning, New York, 1972).
- [52] CAGI-PNEUROP Test Code for the Measurement of Sound from Pneumatic Equipment (also American National Standard S5.1) (Compressed Air and Gas Institute, New York, 1969).
- [53] Exterior Sound Level for Heavy Trucks and Buses, SAE J366b (Society of Automotive Engineers, Warrendale, Pa., 1973).

- [54] Skudrzyk, E., The Foundations of Acoustics: Basic Mathematics and Basic Acoustics (Springer-Verlag, New York, 1971).
- [55] Olson, H. F., System Responsive to the Energy Flow in Sound Waves, U.S. Patent 1,892,644 (1932).
- [56] Clapp, C. W., and Firestone, F. A., An acoustic wattmeter, an instrument for measuring sound energy flow, J. Acoust. Soc. Amer. 13, 124-136 (1941).
- [57] Baker, S., An acoustic intensity meter, J. Acoust. Soc. Amer. 27, 269-273 (1955).
- [58] Schultz, T. J., Acoustic wattmeter, J. Acoust. Soc. Amer. 28, 693-699 (1956).
- [59] Kurze, U., Zur Entwicklung eines Gerätes für komplexe Schallfeldmessungen, Acustica 20, 308-310 (1968).
- [60] Jhaveri, A. G., Design and development of a portable acoustic impedance meter, Annals New York Acad. Sci. 172, 747-756 (1971).
- [61] Olson, H. F., Field-type acoustic wattmeter, J. Audio Eng. Soc. 22, 321-328 (1974).
- [62] van Zyl, B. G., and Anderson, F., Evaluation of the intensity method of sound power determination, J. Acoust. Soc. Amer. 51, 682-686 (1975).
- [63] Schultz, T. J., Smith, P. W., Jr., and Malme, C. I., Measurement of acoustic intensity in reactive sound field, J. Acoust. Soc. Amer. 51, 1263-1268 (1975).
- [64] Rogers, P. H., and Williams, A. O., Jr., Acoustic field of circular plane piston in limits of short wavelength or large radius, J. Acoust. Soc. Amer. 52, 865-870 (1972).
- [65] Stenzel, H., and Bronze, O., Leitfaden zur Berechnung von Schallvorgängen (Springer-Verlag, Berlin, 1958). An English translation of the 1939 edition of this book is available as Naval Research Laboratory Translation No. 130 (available from Photoduplication Service, Library of Congress, as PB 106157).
- [66] Kinsler, L. E., and Frey, A. R., Fundamentals of Acoustics, Second Edition (John Wiley & Sons, New York, 1962).
- [67] Mackawa, Z., Noise reduction by distance from sources of various shapes, Appl. Acoust. 1, 225-238 (1970).
- [68] Tatge, R. B., Noise radiation by plane arrays of incoherent sources, J. Acoust. Soc. Amer. 52, 732-736 (1972).

- [69] Junger, M. C., and Feit, D., Sound, Structures, and Their Interaction (MIT Press, Cambridge, Mass., 1972).
- [70] Cremer, L., Heckl, M., and Ungar, E. E., Structure-Borne Sound: Structural Vibrations and Sound Radiation at Audio Frequencies (Springer-Verlag, New York, 1973).
- [71] American National Standard Method for the Physical Measurement of Sound, S1.2-1962 (American National Standards Institute, New York, 1962).
- [72] Peterson, A. P. G., and Gross, E. E., Handbook of Noise Measurement, 7th Edition (General Radio Company, Concord, Mass., 1972).
- [73] Baade, P. K., Sound radiation of air-conditioning equipment; measurement in the free field above a reflecting plane, Trans. Amer. Soc. Heating, Refrig., and Air-Conditioning Engrs. 70, 217-227 (1964).
- [74] Baade, P. K., Standardization of machinery sound measurement, ASME Paper No. 69-WA/FE-30 (Amer. Soc. Mech. Engrs., New York, 1969).
- [75] Ellison, A. J., Moore, C. J., and Yang, S. J., Methods of measurement of acoustic noise radiated by an electric machine, Proc. Inst. Elec. Engrs. 116, 1419-1430 (1969).
- [76] Moore, C. J., A solution to the problem of measuring the sound field of a source in the presence of a ground surface, J. Sound Vib. 16, 269-282 (1971).
- [77] Acoustic Effects Produced by a Reflecting Plane, Proposed Aerospace Information Report 1327 (Society of Automotive Engineers, Warrendale, Pa.). Not yet approved as of this writing.
- [78] Miles, J. H., Analysis of Ground Reflection of Jet Noise Obtained with Various Microphone Arrays over an Asphalt Surface, NASA TM X-71696 (National Aeronautics and Space Administration, Lewis Research Center, Cleveland, Ohio, 1975).
- [79] Cook, R. K., Waterhouse, R. V., Berendt, R. D., Edelman, S., and Thompson, M. C., Jr., Measurement of correlation coefficients in reverberant sound fields, J. Acoust. Soc. Amer. 27, 1072-1077 (1955).
- [80] Lyon, R. H., Direct and reverberant field amplitude distributions in nearly hard rooms, J. Acoust. Soc. Amer. 33, 1699-1704 (1961).
- [81] Diestel, H. G., Probability distribution of sinusoidal sound pressure in a room, J. Acoust. Soc. Amer. 35, 2019-2022 (1963).
- [82] Andres, H. G., A law describing the random spatial variation of the sound field in rooms and its application to sound power measurements, Acustica 16, 278-294 (1965).

- [83] Waterhouse, R. V., Statistical properties of reverberant sound fields, J. Acoust. Soc. Amer. 43, 1436-1444 (1968).
- [84] Lubman, D., Fluctuations of sound with position in a reverberant room, J. Acoust. Soc. Amer. 44, 1491-1502 (1968).
- [85] Schroeder, M. R., The effect of frequency and space averaging on the transmission responses of multimode media, J. Acoust. Soc. Amer. 46, 277-283 (1969).
- [86] Lubman, D., Spatial averaging in a diffuse sound field, J. Acoust. Soc. Amer. 46, 532-534 (1969).
- [87] Schroeder, M. R., Spatial averaging in a diffuse sound field and the equivalent number of independent measurements, J. Acoust. Soc. Amer. 46, 534 (1969).
- [88] Lyon, R. H., Statistical analysis of power injection and response in structures and rooms, J. Acoust. Soc. Amer. 45, 545-565 (1969).
- [89] Tichy, J., The sound field in a reverberation chamber at low frequencies, J. Acoust. Soc. Amer. 47, 117(A) (1970).
- [90] Waterhouse, R., Sampling statistics for an acoustic mode, J. Acoust. Soc. Amer. 47, 961-967 (1970).
- [91] Waterhouse, R. V., and Lubman, D., Discrete versus continuous space averaging in a reverberant sound field, J. Acoust. Soc. Amer. 48, 1-5 (1970).
- [92] Morrow, C. T., Point-to-point correlation of sound pressures in reverberation chambers, J. Sound Vib. 16, 29-42 (1971).
- [93] Lubman, D., Spatial averaging in sound power measurements, J. Sound Vib. 16, 43-58 (1971).
- [94] Schultz, T. J., Sound power measurements in a reverberant room, J. Sound Vib. 16, 119-129 (1971).
- [95] Tichy, J., The measurement of sound power in a reverberation chamber at discrete frequencies, Proc. Inter-Noise 72 (M. J. Crocker, Ed.), pp 427-432 (Institute of Noise Control Engineering, Poughkeepsie, N.Y., 1972).
- [96] Lubman, D., Waterhouse, R. V., and Chien, C., Effectiveness of continuous spatial averaging in a diffuse sound field, J. Acoust. Soc. Amer. 53, 650-659 (1973).
- [97] Maling, G. C., Jr., Guidelines for determination of the average sound power radiated by discrete-frequency sources in a reverberation room, J. Acoust. Soc. Amer. 53, 1064-1069 (1973).

- [98] Ebbing, C. E., and Maling, G. C., Jr., Reverberation-room qualification for determination of sound power of sources of discrete-frequency sound, *J. Acoust. Soc. Amer.* 54, 935-949 (1973).
- [99] Tichy, J., and Bunde, P. K., Effect of rotating diffusers and sampling techniques on sound-pressure averaging in reverberation rooms, *J. Acoust. Soc. Amer.* 56, 137-143 (1974).
- [100] Lubman, D., Precision of reverberant sound power measurements, *J. Acoust. Soc. Amer.* 56, 523-533 (1974).
- [101] Lubman, D., and Associates, Review of Reverberant Sound Power Measurement Standard and Recommendations for Further Research, NBS Tech. Note 841 (National Bureau of Standards, Washington, D. C., 1974).
- [102] Dodd, G., Steady state room transmission response parameters -- their distributions and relationships, and implications of these relationships, *J. Sound Vib.* 36, 473-483 (1974).
- [103] Chien, C., Waterhouse, R., and Lubman, D., Spherical averaging in a diffuse sound field, *J. Acoust. Soc. Amer.* 57, 972-975 (1975).
- [104] Waterhouse, R. V., Power output of a point source exciting a single Cartesian mode, *J. Acoust. Soc. Amer.* 49, 9-16 (1971).
- [105] Dodd, S. D., and Doak, P.E., Some aspects of the theory of diffusion and diffusers, *J. Sound Vib.* 16, 89-98 (1971).
- [106] Ebbing, C. E., Experimental evaluation of moving sound diffusers for reverberant rooms, *J. Sound Vib.* 16, 99-118 (1971).
- [107] Lubman, D., Distribution of reverberant sound in large rooms, *J. Acoust. Soc. Amer.* 39, 1266(A) (1966).
- [108] Tichy, J., The effect of rotating vanes on the sound field in reverberation chambers, *J. Acoust. Soc. Amer.* 42, 89(A) (1971).
- [109] Tichy, J., The effect of boundary conditions on the statistical properties of the sound field in enclosures, *J. Acoust. Soc. Amer.* 50, 98(A) (1971).
- [110] Lubman, D., Guidelines for the design of rotating diffusers, *J. Acoust. Soc. Amer.* 55, 447-448(A) (1974).
- [111] Peterson, A. P. G., Device noise and background noise from a statistical point of view, *Noise Control Engineering* 4, 76-83 (1975).
- [112] Diehl, G. M., *Machinery Acoustics* (John Wiley & Sons, New York, 1973).
- [113] Diehl, G. M., Sound power measurements on large machinery installed indoors, *Compressed Air Magazine* 79, 8-12 (January 1974).

- [114] Leasure, W. A., Jr., and Quindry, T. L., Methodology and Supporting Documentation for the Measurement of Noise from Medium and Heavy Trucks, NBSIR 74-517 (National Bureau of Standards, Washington, D. C., 1974).
- [115] Bettis, R. A., and Sexton, M. Z., The effect of test site topography in vehicle noise measurement, J. Acoust. Soc. Amer. 54, 332(A) (1973).
- [116] Sheth, N. J., and Gegenky, P. S., The influence of test site on exterior vehicle noise measurements, SAE Paper No. 740967, presented at Automobile Engineering Meeting, Toronto, Canada (Society of Automotive Engineers, Warrendale, Pa., 1974).
- [117] Flynn, D. R., Accuracy and precision (an editorial), Noise Control Engineering 2, 2 (1974).

PART III SELECTION OF MEASUREMENT METHODOLOGY APPROPRIATE TO A SPECIFIC PRODUCT

This part of the report consists of a series of flow charts which depict the development of appropriate procedures for measuring the noise emission of particular classes of products. These charts are intended to serve as reminders and check lists of the factors which are discussed in detail in Parts I and II.

Figure 35 shows the overall development of appropriate test procedures. The five boxes shown with heavy borders are expanded in Figures 36-40.

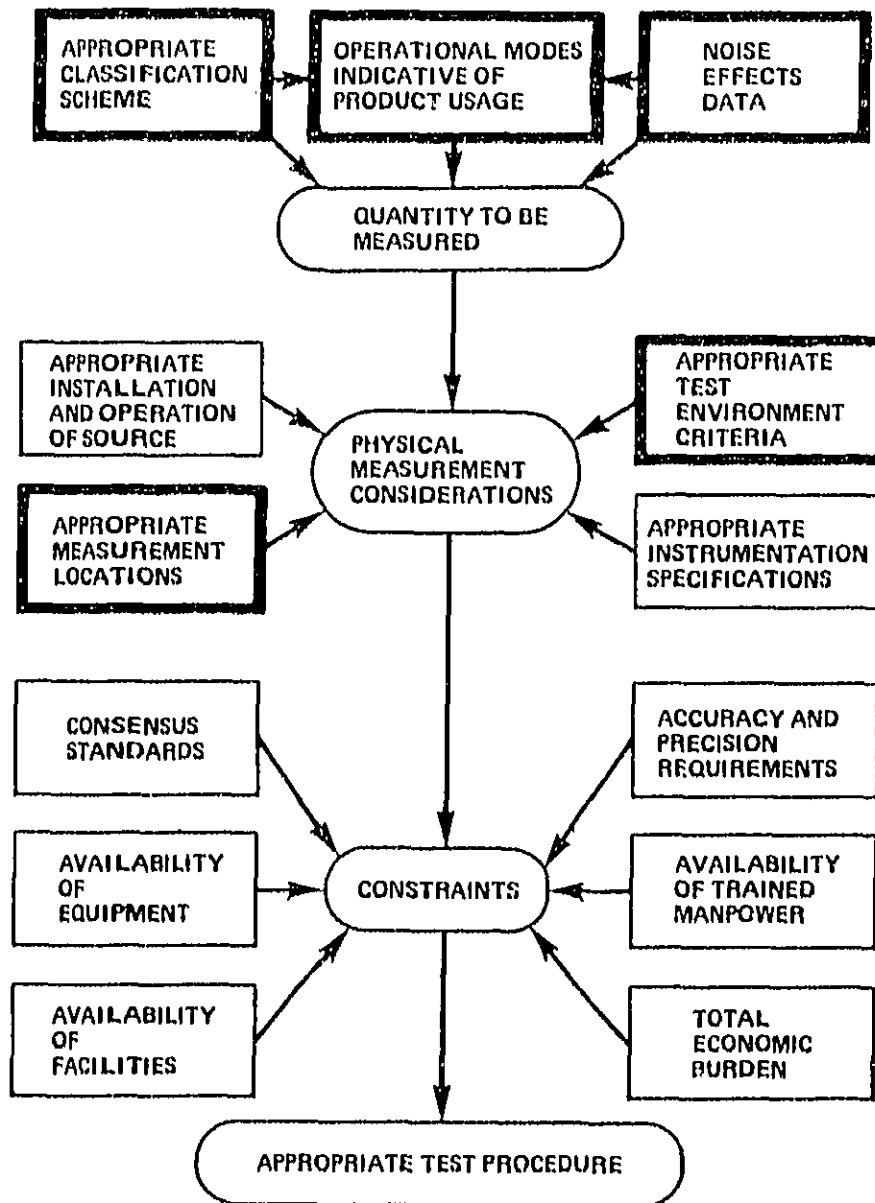

Figure 35. Development of appropriate test procedure.

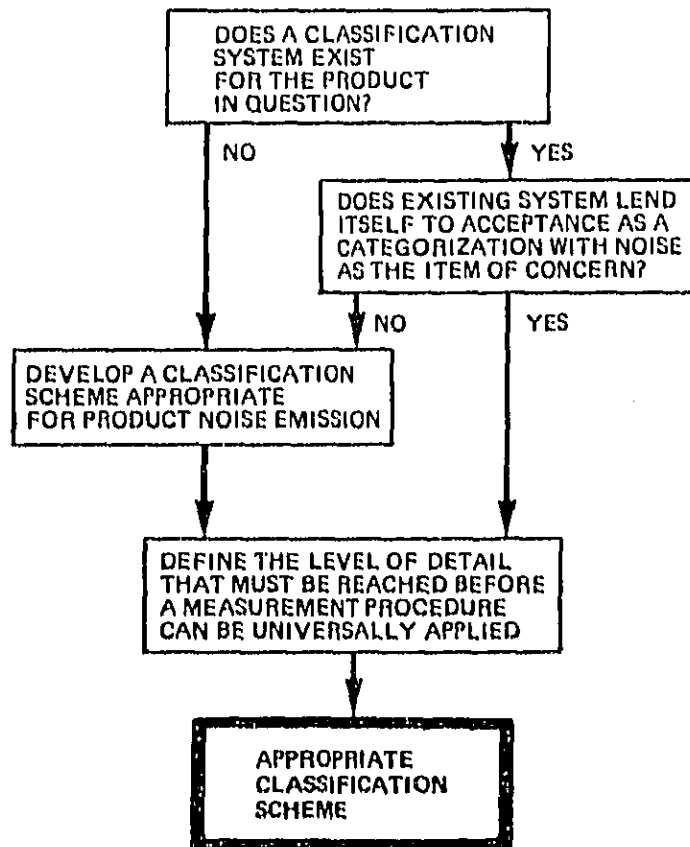

Figure 36. Development of appropriate classification scheme.

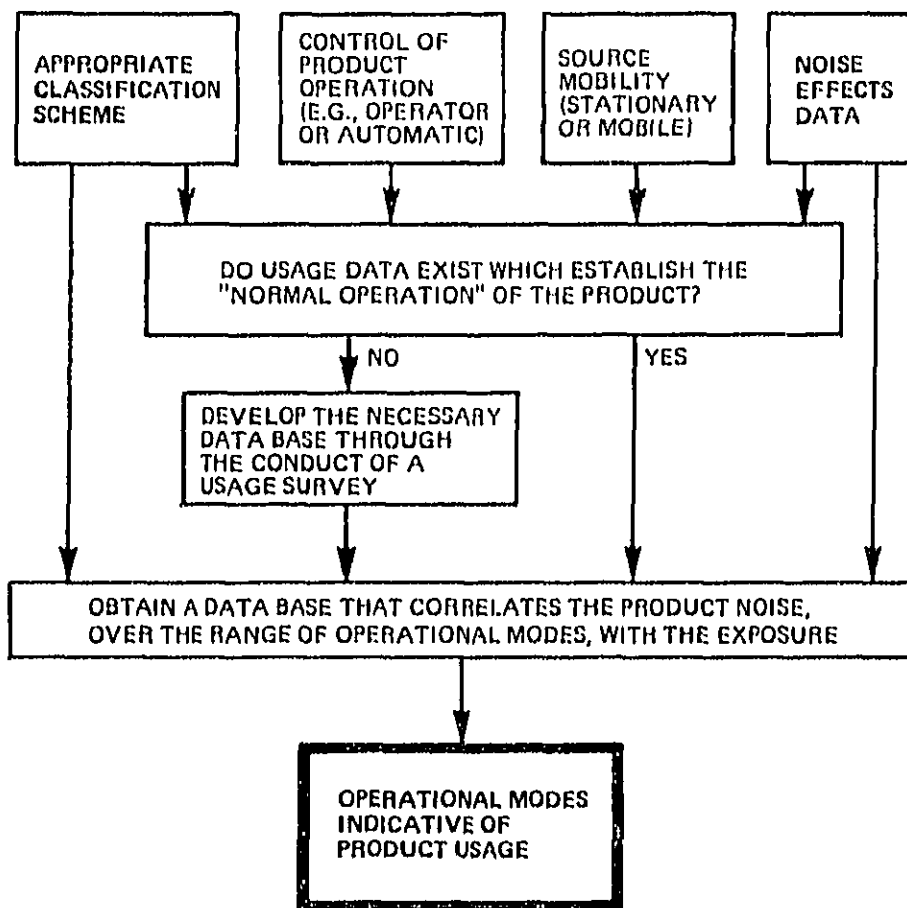

Figure 37. Identification of operational modes indicative of product usage.

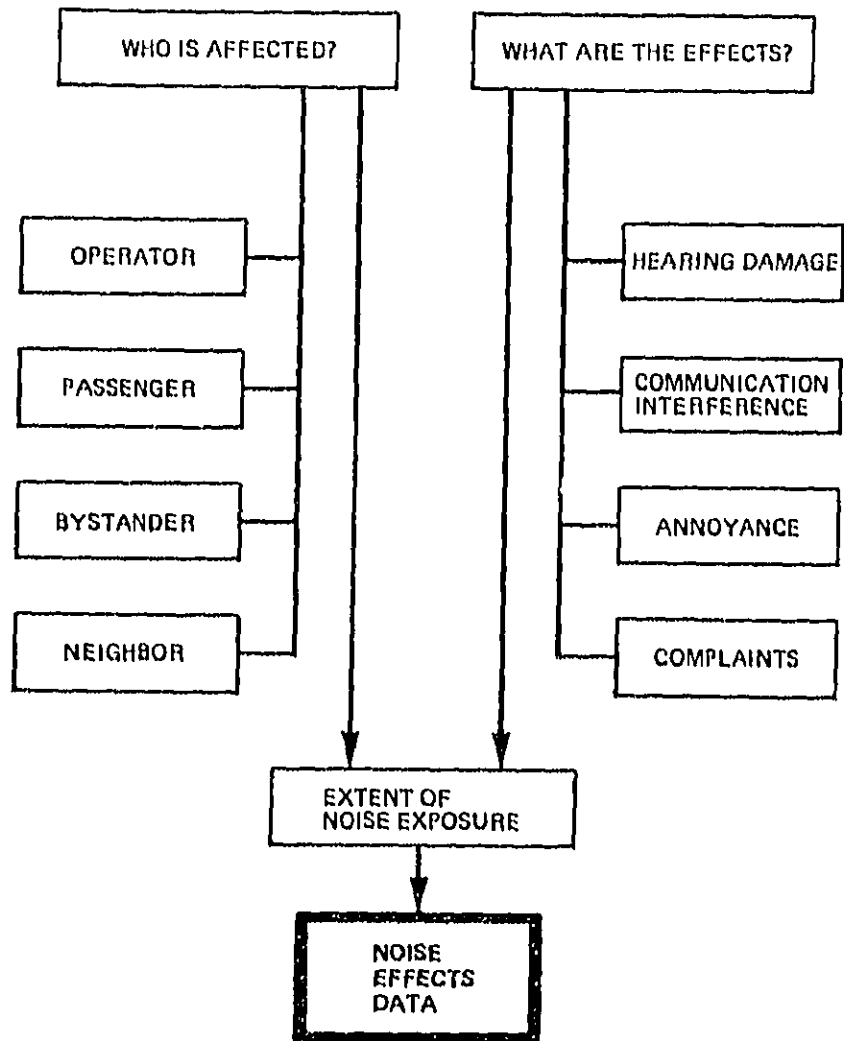

Figure 38. Collection of noise effects data.

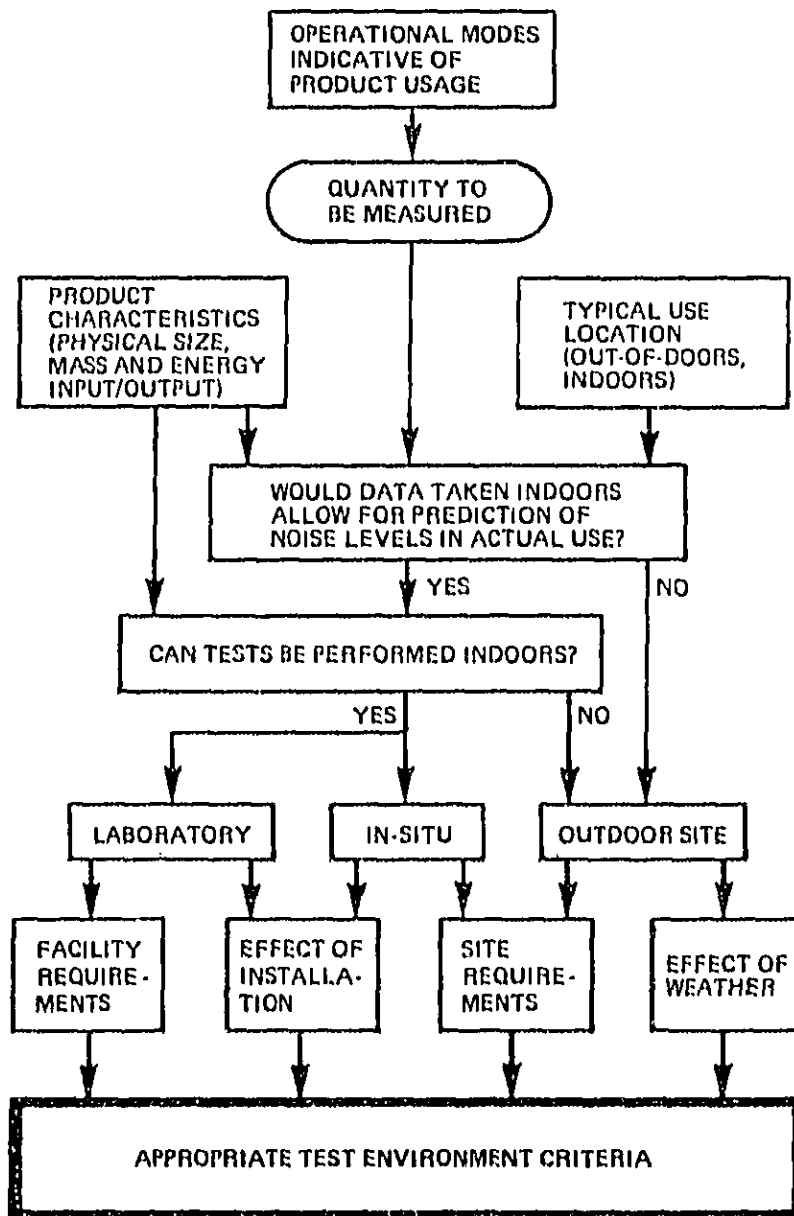

Figure 40. Selection of appropriate test environment criteria.

Appendix A.
**List of Participants at Government/Industry Meetings on Noise
 Measurement Methodology for the Environmental Protection
 Agency's Noise Emission Regulations**

<u>Meeting</u>	<u>Date</u>	<u>Participants</u>
Representatives of the Assn. of Home Appliance Manufacturers (AHAM)	July 7, 1972	D. Flynn (NBS) W. Leasure, Jr. (NBS) R. Mann (Westinghouse) H. Phillips (AHAM) J. Weizerick (AHAM)
Representatives of the American Road Builders Assn. (ARBA), the Construction Industry Manufacturers Assn. (CIMA), and contractors	July 20, 1972	J. Benson (CIMA) J. Codell III (Codell Construction Co.) R. Crowe (ARBA) G. Diehl (Ingersoll- Rand) D. Flynn (NBS) W. Land (Contractor) H. Larmore (CIMA) W. Leasure, Jr. (NBS) B. Miller (ARBA) J. Oman (Oman Construction Co.) D. Powlson (Tennessee Road Builders)
Representative of the General Services Administration (GSA), Public Building Services	November 13, 1972	W. Leasure, Jr. (NBS) R. Rice (GSA) A. Rubin (NBS)
Representative of the Acoustical and Insulating Materials Assn. (AIMA)	November 29, 1972	D. Flynn (NBS) R. LaCombe (AIMA) W. Leasure, Jr. (NBS)
Representatives of the U. S. Postal Service (P. O.)	December 4, 1972	D. Cornog (P. O.) R. Flohr (P. O.) W. Hull (P. O.) W. Leasure, Jr. (NBS) A. Rubin (NBS)

Representatives of the Dept. of Transportation (DOT), locomotive manufacturers, the Assn. of American Railroads (AAR), and the American Short Line Railroad Assn. (ASLRA)

December 5, 1972

P. Baker (General Electric)
D. Bray (DOT/FRA)
W. Clone (DOT/OHA)
J. Coxe (AAR)
H. Croft (ASLRA)
D. Flynn (NBS)
K. Hawthorne (AAR)
W. Leasure, Jr. (NBS)
R. Lucas (DOT/FRA)
R. Pribramsky (General Motors)
A. Rubin (NBS)
J. Wesler (DOT/OHA)

Representatives of the Air Conditioning and Refrigeration Institute (ARI)

December 6, 1972

W. Bayless (Borg-Warner)
R. Kelto (Air Temp.)
W. Leasure, Jr. (NBS)
A. Meling (ARI)
A. Rubin (NBS)
J. Schreiner (Carrier)

Representatives of the National Electrical Manufacturers Assn. (NEMA)

December 7, 1972

W. Leasure, Jr. (NBS)
H. Michener (NEMA)
R. Hims (NEMA)
R. O'Brien (NEMA)
A. Rubin (NBS)
J. Werner (NEMA)

Representatives of the International Snowmobile Industry Assn. (ISIA) and the Society of Automotive Engineers Motorized Snow Vehicle Subcommittee

December 7, 1972

J. Arbuckle (ISIA)
R. Croteau (Bombadier Ltd.)
J. Glacen (Deere & Co.)
G. Gowling (Bombadier Ltd.)
L. Haas (Scorpion, Inc.)
W. Leasure, Jr. (NBS)
J. Heabitt (ISIA)
A. Rubin (NBS)
J. Spechko (Outboard Marine Corporation)

SECRET AVIAN 1215 1972

Representatives of
the Engine Manu-
facturers Assn.
(EMA) and the Society
of Automotive Engineers
(SAE)

December 8, 1972

R. Canfield (American
Motors)
J. Crowley (Case)
W. Hamilton (Allis
Chalmers)
T. Hutton (EMA)
J. Jensen (John Deere)
J. Johnson (Caterpillar)
D. Kabele (SAE)
R. Law (Detroit
Diesel Allison)
W. Leasure, Jr. (HBS)
C. Leber (Caterpillar)
R. Lincoln (Outboard
Marine)
J. McNally (Caterpillar)
J. Nadolny (Teledyne
Wisconsin)
A. Rubin (HBS)
C. Salter (EMA)
R. Staadt (Inter-
national Harvester)
D. Stephenson (Out-
board Marine)
T. Wu (International
Harvester)
T. Young (EMA)

Representatives of
the American Trucking
Assns. (ATA)

December 12, 1972

W. Gibson (ATA)
L. Kibbee (ATA)
W. Leasure, Jr. (HBS)
A. Rubin (HBS)
R. Tilley (Safeway
Stores)

Representatives of
the Motor Vehicle
Manufacturers Assn.
(MVMA)

December 20, 1972

L. Bridenstine (MVMA)
J. Damian (Ford)
T. Dolan (General
Motors)
F. Kishline (American
Motors)
W. Leasure, Jr. (HBS)
R. Ratering (General
Motors)
A. Rubin (HBS)
R. Staadt (Inter-
national Harvester)
R. Vlewig (MVMA)
R. Wusko (MVMA)

RECEIVED AVIATION LIBRARY

Appendix B.

Pertinent Sections of the Noise Control Act of 1972

For the benefit of those readers not familiar with the Noise Control Act of 1972, Public Law 92-574, the following summary of pertinent sections of the Act is presented.

NOISE EMISSION STANDARDS FOR PRODUCTS DISTRIBUTED IN COMMERCE

- Sec. 6. EPA is given authority to prescribe and amend standards limiting noise generation characteristics for any product or class of products which has been identified as a major source of noise and which falls in the following categories: construction equipment, transportation equipment (including recreational vehicles), any motor or engine, and electrical or electronic equipment. EPA may issue regulations for products in other categories if it is necessary to protect the public health or welfare. The standards must be "...based on criteria published under Section 5," and "requisite to protect the public health and welfare, taking into account the magnitude and conditions of use of such product (alone or in combination with other noise sources), the degree of noise reduction achievable through application of the best available technology, and the cost of compliance."

The manufacturer of regulated products must warrant that its product is designed and built so as to conform at the time of sale with such regulation. The cost of this warranty cannot be passed on by the manufacturer. States and political subdivisions are prohibited from setting noise emission levels different from those promulgated by EPA, but remain able to regulate use, operation or movement of products.

LABELING

- Sec. 8. For any product which (a) emits noise capable of adversely affecting the public health or welfare, or (b) is sold wholly or in part on the basis of its effectiveness in reducing noise, the EPA must require the manufacturer of such product to give notice of the noise level or its effectiveness in reducing noise to the consumer. EPA's regulations must indicate the form of such notice and the method and unit of measurement must be prescribed.

RAILROAD NOISE EMISSION STANDARDS

- Sec. 17 After consultation with the Department of Transportation, EPA is required to promulgate regulations for surface carriers engaged in interstate commerce, including regulations

governing noise emission from the operation of equipment and facilities of such carriers. The effective date for such regulations must permit the development and application of the requisite technology. The Secretary of Transportation is charged with the responsibility of assuring compliance with EPA's regulations. State and local governments are prohibited from establishing operational noise emission limits different from applicable federal standards, but the Administrator may allow a different standard if he determines in consultation with the Secretary of Transportation that local conditions necessitate such different regulations.

MOTOR CARRIER NOISE EMISSION STANDARDS

- Sec. 18 The provisions of this section are nearly identical to Sec. 16 except that they apply to "a common carrier by motor vehicle, a contract carrier by motor vehicle, and a private carrier of property by motor vehicle as those terms are defined in the Interstate Commerce Act (49 U.S.C. 303(a))."

DEVELOPMENT OF LOW-NOISE EMISSION PRODUCTS

- Sec. 15 Provides for Federal procurement of and public notice about products certified as "low-noise-emission products" (defined as: any product which emits noise in amounts significantly below the levels specified in noise emission standards under regulations applicable under Sec. 6 at the time of procurement to that type of product). The Administrator is allowed to establish a Low-Noise-Emission Product Advisory Committee to assist him in determining which products qualify. Once an application for certification is received and the product is determined to be a low-noise-emission product, the Administrator must certify the product as such if he determines that the product is a suitable substitute for a type of product at that time in use by agencies of the Federal government. Various instructions as to when the Federal government is required to purchase such products and when the EPA is required to publish information about its determinations are given."

In setting noise emission standards for products distributed in commerce, the Environmental Protection Agency is required (see Sec. 6 of Public Law 92-574) to base these standards on criteria published under Sec. 5. Section 5 of the Act is summarized below:

IDENTIFICATION OF MAJOR NOISE SOURCES, NOISE CRITERIA AND CONTROL TECHNOLOGY

- Sec. 5 (1) requires EPA to publish criteria which reflect the kind and extent of all identifiable effects on the public health or welfare resulting from differing quantities and qualities

of noise (within 9 months); (2) requires EPA to publish information on levels of environmental noise which in defined areas under various conditions are requisite to protect the public health and welfare with an adequate margin of safety (within 12 months); (3) requires EPA to publish a report identifying major sources of noise, and giving information on techniques for control of noise (within 18 months).

Appendix C.

Uncertainty of Measurement

If quantitative noise regulations are to be effective and equitable, it is essential to have a good understanding of the uncertainties extant in the associated measurements. In legal proceedings this uncertainty represents the "shadow of doubt" associated with a measurement. A clear statement of the factors entering into the uncertainty computation and the data on which it is based should be available for "cross-examination."

In a legal proceeding (and in regulatory operations generally) a statement as to what measurement process would be accepted as correct is a necessity -- otherwise regulation would not be possible. The uncertainty of a measurement should therefore be stated in terms of the results which would have been obtained by the "accepted" process. In the case of some standards, reference to the unit as maintained by the National Bureau of Standards may be appropriate. In other cases, results by a selected agency or by an average of the measurement processes of several organizations may serve as a reference.

Two characteristics of measurements must be accounted for. First, that successive measurements of the same quantity will disagree, and second, that the long-run average by two different realizations of the same method of measurement will differ. One's model of a measurement process must therefore be enlarged to include both the variability and possible offset of the process from that which would be accepted as correct.

It is in the concept of a repetition of a measurement that the uncertainty of measurement can be given operational meaning. Measurements can be regarded as arising from a process whose properties can be determined from an appropriate sequence of such repetitions. It is only when one can attribute the properties of the process to the isolated single measurement that a defensible statement of its uncertainty can be made. To be able to do this the process must have predictability, i.e., be in a state of statistical control at the time of the measurement so that the use of the current values of the process parameters is valid.

Limits for the Effects of Random Error

The crucial step in assessing the effects of random error is that of defining the set of repetitions over which the measurement is to apply. At the very minimum it would involve repetitions with the same instrument-operator-procedure configuration. It would include sampling variability when that is appropriate and include a number of components of variance such as those associated with day-to-day differences, operators, instruments, etc.

All of these factors which enter into the random error calculation could, in principle, be varied in repeated measurement so that their effects could be mitigated by averaging over the set of repetitions. Those which cannot be so averaged out are regarded as systematic errors which account for the offset of

one process relative to another.

To assess the possible extent of random error of the quantity, y , where y is a specified function of random variables x_1, x_2, \dots, x_n and constants c_1, c_2, \dots so that $y = f(x_1, x_2, \dots, x_n, c_1, c_2, \dots)$, let us assume that a standard deviation, σ_y , is available. This standard deviation will, in general, involve many components of variance, the constants, c_1 , and will depend on the functional form $f()$. To go from this standard deviation to a bound for the random error (e.g., three standard deviations) involves some arbitrariness both in the assumed nature of the probability distribution involved and the desired degree of coverage.

Offset of Measurement Process

The offset of one measurement process relative to another (or of a process from that accepted nationally) may arise from deficiencies in the mathematical model or in realizations of the specified process. To this one must add systematic error in the prescribed standards, and the fact that the corrections for environmental and other effects may not account for all the effects of such variables on the particular measurement process.

The procedures for arriving at bounds to the possible offset of the process will involve direct measurement by introducing changes into the process and observing the effect, the use of values from critical experiments run on similar processes, and other similar techniques which have in common the fact that they are based on observation (not judgement).

In some cases it is possible to determine the offset of a measurement process by measuring a "control" in the form of some reference meter or standard signal. It is necessary that the reference items be similar in all important respects to the items being measured, and that it be measured by the same procedures used in the regular workload. When the bias correction is made, the process would be regarded as being free from systematic errors from the source represented by the item. The random error in the applied correction becomes part of the random error of the process, of course.

Control of Measurement

At some point in time one will have values for the bound, R , to the effect of random error and a bound, E , for the possible offset of the process relative to nationally accepted reference standards or measurement processes. These values are used to characterize the process and these properties can be applied to individual measurements from the process if the process remains in a state of control.

Some evidence is therefore needed to establish that the process is "in control." Measurements in a reference item made periodically throughout the year are an example of the type of redundancy needed to provide the assurance of consistency. When coupled with an independent outside check on the offset of the process, one has evidence of the validity of the uncertainty statement.

An out of control condition signifies that predictability has been lost and one should therefore redetermine the process parameters to arrive at a new uncertainty statement.

Uncertainty

The uncertainty of a reported value could, in principle be reduced to $\pm E$, the offset or systematic error of the process, by increasing the number of measurements to be made. Any such increase in the number of measurements would not change the process average, of course. If one or only a few measurements are made, then the uncertainty is increased by the random errors so that the uncertainty* of a measurement from a process in control is

$$\text{uncertainty} = \pm(E + R)$$

*The modification for asymmetrical limits are obvious.

RECT AVAIL ABLE ANOV

Appendix D.
**Possible GATT Code of Conduct for Preventing Technical
Barriers for Trade**

The United States and other major trading nations through the General Agreement on Tariffs and Trade, have been investigating the international trade problems arising from the development of different regional, national, and local product standards and technical regulations and the various procedures for assuring conformity with them[1]. Most of these standards barriers are side effects of efforts to protect the public welfare rather than deliberate discrimination, and the GATT negotiators are trying to find a solution that will not hamper the achievement of these objectives[2].

The following discussion on the GATT code of conduct is reprinted from the ASTM Standardization News with permission of the American Society for Testing and Materials[1].

"It was the recognition of the problems presented by standards and the inadequacy of the GATT provisions for dealing with them that led the contracting parties to begin the development of a standards code. Furthermore, the United States and other countries were becoming increasingly concerned about European plans to conclude regional standards arrangements on an exclusive basis. In 1971 Working Group III of the Committee on Trade in Industrial Products began the drafting of such a code. The working group agreed on certain hypotheses of which two should be noted. One was that the solution developed should take the form of a binding code subject to a reservation that the final product may be changed to a voluntary code or set of principles. Another was that the GATT should not become involved in writing standards or certifying that products conform to standards.

"The draft GATT standards code which was developed deals separately with the preparation, adoption, and use of mandatory standards by central and local government bodies; the preparation of voluntary standards by central and local government bodies; and the preparation of standards by voluntary standards bodies. In each case standards are to be formulated and applied so as not to afford protection to domestic production, and they are to be based upon 'appropriate' international standards. There shall be active participation in international standards organizations. Wherever appropriate, standards are to be specified in terms of performance rather than design. Proposed standards not based on international standards must be published, consideration given to comments received, and a reasonable time allowed for foreign suppliers to adapt to the standards (except when urgent problems of health, safety, environmental protection, or national security exist). All mandatory standards must also be published. In addition, adherents of regional standards organizations shall use their "best efforts" to ensure that the standards will expedite progress toward the preparation of international standards and that the regional

organizations comply with the requirements just described.

"Compliance by local government bodies is subject to 'reasonable means' being used to ensure compliance with these requirements. Similarly, standards of voluntary bodies (such as ANSI) are conditioned by a 'best efforts' stipulation.

"In determining conformity with mandatory standards, central governments must likewise employ methods that do not afford protection to domestic production and test methods must be harmonized, as far as practicable, on an international basis and be published. Procedures should permit tests to be carried out in the exporting country and should recognize other equivalent test methods.

"Where a positive assurance is required that imported products conform to a mandatory standard, whenever possible a declaration by the supplier or by a quality assurance body in another member country should be accepted. If tests are carried out in the importing country they should be on the same basis as tests of domestic products.

"Where quality assurance systems are operated or relied on by the central government to assure conformity with its mandatory standards, the code contains safeguards as to fairness and nondiscrimination. Here a major difference of view exists, particularly when the quality assurance system is international or regional in nature. The U. S. view is that participation in quality assurance systems should be open to all signatories of the code from the outset and apply equally to foreign and domestic suppliers. Other countries have argued that there should be allowance to limit participation in the initial stages of the system.

"There are provisions in the code to ensure that information be readily available about standards and quality assurance systems. A place where such information may be obtained is to be established in each country and relevant technical assistance is to be provided to signatories to the code, especially the developing countries.

"Some countries have expressed reservations about the retroactive provisions of the draft code. This section states that if existing standards -- mandatory or voluntary -- or quality assurance systems afford protection to domestic industries, then signatories shall bring them into conformity as soon as possible. This would have different consequences depending on the nature of the changes required. For example, retroactivity involving changes in existing legislation would be considerably more difficult than changes in administrative regulations. Finalization of this section will await completion of the other sections of the code.

"Finally, a 'Committee for Preventing Technical Barriers to Trade' would be established for signatories to consult on implementation of the code, to investigate complaints, and to recommend actions after

completion of an investigation. It is also proposed that the committee be empowered to authorize suspension of code obligations for violators and refer serious violations to the GATT contracting parties for appropriate action. This question of sanctions is controversial and some countries favor other, less severe enforcement provisions.

"Some of the drafters also have reservations about the binding nature of the code, particularly over the difference in how it would affect the obligation of a federal as opposed to a unitary form of government. In the former many mandatory standards are developed by state and local bodies which the national government in some cases may not effectively control. In the latter all mandatory standards are developed by the national government. A related problem is that some countries maintain only mandatory standards while in others there are many voluntary and so-called 'quasi-voluntary' ones. (Quasi-voluntary standards are those that are developed in some European countries by a cooperative effort between industry and government, but are voluntary with the proviso that they can be made mandatory at the option of the government.) Thus, those countries that rely mainly on mandatory standards would assume greater obligations under the code than those that rely on voluntary or quasi-voluntary standards. The draft code will address these problems by placing different levels of obligations on the signatories.

"Obviously the effects a binding international code of standards would have cannot be fully measured until final agreement is reached on specific provisions; however, a few conclusions can be ventured with a fair amount of confidence. In the first place the role of international standardization and the organizations which perform it will become much more important. From that fact will flow greatly increased responsibilities on the American National Standards Institute (ANSI) and its activities, since ANSI represents the U. S. interest in international standardization work by the nontreaty organizations such as the ISO and IEC (the International Electrotechnical Commission), which in fact perform much of the international standards work. ANSI will therefore need the full support of the whole spectrum of American industry if it is to have the strength and resources to fulfill its task.

"American industry should benefit from the code. The code will encourage open certification systems in which our industry can participate if it is willing to assume the responsibilities of membership. Thus the certification arrangements of CEN (European Standards Coordinating Committee) and CENELEC (European Committee for the Coordination of Electrotechnical Standards) would have to be open instead of restricted to Europeans as they are now. In addition the code would place even greater pressure on the European communities to use international norms in developing their regional standards and certification systems.

"Finally, the code may necessitate changes in current U. S. legislation and administrative practices of regulatory bodies. This aspect is complex and is being carefully explored."

References for Appendix D

- [1] Travaglini, V., Removing barriers to trade through GATT, ASTM Standardization News 3(11) (November 1975).
- [2] Travaglini reports on GATT code negotiations, ANSI Reporter (July 7, 1975).

Appendix E.

Methods of Labeling

In the development of appropriate procedures for labeling products as to their noise emission, it is useful to distinguish among the following four concepts:

- o Determination of the noise emission of machinery or equipment involves the actual measurements which are carried out according to a specified test procedure.
- o Designation of the noise emission is in terms of a particular quantity (such as A-weighted sound power level or perceived noise level) expressed in a particular unit (such as decibel). Designation frequently involves combining the measured data in a prescribed manner in order to obtain some single-figure rating, usually one that can be expected to correlate with human response.
- o Classification involves systematic arrangement of designated noise emission values into groups or categories according to established criteria. Classification typically implies subdivision of the range of noise emission values into a series of intervals which are large enough that the difference between adjacent classes is "significant", in some sense. These intervals may be of fixed, equal size (e.g., 5 dB) or may be derived in a statistical sense (e.g., quartiles). Classification frequently, but not always, implies some form of coding in which a system of words, numbers, letters, or other symbols is used to represent the several classes. The coding system can either be "absolute", so that a given noise emission value would always be assigned the same coding symbol, or "relative", so that the coding symbol conveys information concerning the relationship between the noise emission value of a particular machine or model and the distribution of noise emission values for the family of similar equipment. The coding may also convey information about the particular family to which the machinery belongs, the year to which the classification corresponds, or other information necessary to minimize any possible confusion.
- o Labeling means to furnish or affix written or printed matter in order to furnish the purchaser or user with information concerning the noise emission of the product. This information may include the designation of the actual noise emission and/or the classification of the noise emission.

Voluntary standards organizations have been and are addressing the questions of how to designate and/or classify the noise emission of products. A recent national standard[1] designates the noise emission of small stationary sources in terms of the Product Noise Rating (PNR), which is obtained from the A-weighted sound power level, adjusted by a constant such

that the rating is approximately equal to the space average of the A-weighted sound pressure level at the specified rating distance (usually 1 meter). Radiation from a sound source on a reflecting surface is assumed.

At the international level there currently is interest in expressing noise emission directly in terms of the A-weighted sound power level, with the unit being the bel rather than the decibel so as to reduce confusion between sound pressure level and sound power level[2]. Such a document has just been approved at the national level[3].

A group under the jurisdiction of ISO/TC43 (Acoustics)/SC1 (Noise) is currently considering a possible international standard on classification and labeling of equipment and machinery as to noise emission. In the current draft of this proposal[4], noise emission would be designated in terms of the A-weighted sound power level. An absolute classification scheme is proposed in which the sound power level is rounded up to the nearest 5 dB. The proposed relative classification scheme also uses a 5 dB class interval: Class 1 would include machinery which is "representative of the guaranteed noise emission number to be expected from well designed machines of good workmanship belonging to the family" in question;" Class 2 would include machines for which the guaranteed noise emission is 5 dB less than in Class 1; Class 3 machines would be at least 10 dB quieter than those in Class 1, etc. It has been suggested that the Class number be identified by showing the appropriate number of stars.

In considering classification or labeling schemes for noise emission it is important to consider who is the intended user or audience. A label, or other documentation, which conveys the noise emission designation and/or classification should enable fair comparisons among competing products and should assist purchasers or users in assessing the noise impact of the product. The user, however, may be, for example, (1) an engineer who needs to determine the effect of the product on compliance with hearing conservation regulations, (2) a construction superintendent who has to comply with zoning regulations, or (3) a private citizen who simply wants a "quiet" appliance for his home. Both the information needs and the technical sophistication of these users will vary widely and the information conveyed must be adequate for the more sophisticated user while at the same time must not be confusing to persons with less technical backgrounds.

The acoustical consulting firm of Bolt Beranek and Newman has just completed, for the U. S. Environmental Protection Agency, a study of problems and considerations involved in labeling products as to their noise emission or control characteristics. Thus in this brief appendix there is no need to delve very deeply into the many questions involved with establishing a viable noise labeling program. However, there are a few key points that can beneficially be mentioned.

*Note: "A family of machines or equipment in a group... of a similar design or type or meeting the same performance requirements for which it is reasonable to establish a noise class."

Labeling data could be provided in two ways. The label itself might be in the form of detailed acoustic data, e.g., octave-band sound power levels which the user could utilize in placement of the machines within the workplace. Or there could be a "cookbook" application guide which would be used in conjunction with the simple general public label which would allow the purchaser to predict what sound levels could be expected at some distance from the noise source, e.g., at the property line. There are several possible labeling schemes which deserve consideration. They include single number ratings, single letter ratings, color codes, actual sound level values or sets of data.

A single number rating has, as its main value, simplicity. However, public education would be necessary to assure acceptance and thus success of a single number labeling scheme. Assume that products can be labeled on a single number scale ranging from 1-10. The initial problem is that the difference between adjacent numbers (e.g., difference between a 3 and a 4) should be acoustically significant. In other words, the public would have to be able to discern the product improvement from one number to another without the assistance of sophisticated instrumentation. In acoustics, it is generally accepted that approximately a 3 dB difference must exist before the human ear consistently can detect any difference. This question of the acoustic level change between adjacent numbers, letters, colors, etc., is an inherent problem with any labeling system.

A second problem is determining what meaning the number system already has with the public. One might naively expect that a numbering system would work perfectly with 1 the quietest and 10 the noisiest. However, one could think of 10 as being larger than 1; therefore, a product rated 10 would provide more of something than a product rated 1. The more in this case could either be more noise or more noise abatement. In addition, in the educational system utilizing a numerical grading system, 100 is a perfect score.

The single letter rating, like the single number, has the advantage of being simple. Moreover, the problem of public education might be somewhat easier, because most people in the United States have been exposed in varying degrees to the formal education process that traditionally utilizes an A, B, C grading system. In all cases A is the best. Also people have been further familiarized with this grading system since it is now applied to the grading of meat and dairy products. Because of this, it seems that if the best product -- in this case the quietest -- were labeled A and Z the noisiest, consumers would not find this rating scheme to be inconsistent with other grading systems with which they are familiar.

Use of a color code is another easy method of labeling but it too involves educational problems. There are only three colors -- red (stop), yellow (caution), and green (go) -- whose meanings most people would recognize immediately. Three colors are probably not enough to establish an adequate labeling scheme. The addition of other colors to the three already mentioned could result in a massive educational problem. Furthermore, a significant percentage of the population is partially color blind.

Another alternative would be to list the noise emission (sound pressure or sound power level) produced by the product directly on the package itself. This method has the advantage of giving the consumer an absolute value which he can directly compare with the sound values of other products. It has been stated (e.g. [5-6]) that consumers desire more specific information and are capable of understanding more than they are usually given credit for. For example, women's hosiery is graded according to its "gauge". The fact that gauge indicates how many needles are used in 1-1/2 inches of the loom is not important to know. It is enough that the consumer knows that the higher the gauge, generally the more durable the hosiery. The same may be true about sound level values. It may not be necessary for a person to understand the technical aspects of the decibel. They merely need to be told enough so that they can interpret in an adequate way how A-weighted sound level is a measure of a product's "noise quality". This could probably be accomplished by inserting a well-written article in some of the more popular magazines and newspapers discussing in layman's terms the meaning of the terminology and units.

A final labeling measure which could be used is a set of data which describes the noise emission spectrum of the product. Such a label might not really be needed or useful for the general public; however, this type of information might be the only label thus far mentioned that would satisfy some of the needs of the business and industrial community. The typical plant owner needs information that will tell him whether the equipment he is purchasing will violate any noise regulations under his use conditions. This type of information is necessary so that plant layouts can be designed to achieve minimum noise levels, utilizing natural shielding of machinery and equipment, avoiding location of high-intensity noise sources near walls, reflective surfaces, work stations, and areas frequented by employees. A color code or single number or letter rating by itself will not provide the user the kind and amount of information he needs. Any of the simple labels coupled with an application guide in cookbook form could serve his needs if the guide were properly designed. The decisions made by the business community can involve considerable expenditures and the purchaser could avoid a mistake if it is possible to provide him with the necessary information.

There is one voluntary labeling system which already exists and is well accepted in the area of acoustics. The Air-Conditioning and Refrigeration Institute utilizes 1/3-octave band sound power determinations in a reverberant room as the basis for its sound labeling system. The sound power data are converted into a single number rating (numerical classification scheme ranging from 14-21 with increasing noise level corresponding to increasing numbers -- a change of 1 corresponds to about 3.3 dB) and an application guide that provides the steps necessary to convert a single number into a predicted sound level at a given distance from the source. The labeling system is primarily aimed at the distributors and installation contractors; however, education booklets describing the meaning of the ratings have been developed for the consumer.

Since this labeling scheme does presently exist and has some history of acceptance, it will be briefly discussed to provide some additional insight into the problems associated with the development of a labeling scheme that will benefit and be understood by the audience for which the label is intended.

The Air-Conditioning and Refrigeration Institute began "sound rating" outdoor units in 1971 with publication of its first Directory of Sound-Rated Outdoor Unitary Equipment.

Under this voluntary program, all participating manufacturers (the models listed in the most recent directory represent more than 90 percent of the total U. S. output of these types of equipment) are required to rate the noise emission of their outdoor units in accordance with specified procedures. Each manufacturer certifies his own equipment and he must certify his entire line, not just selected models, to be listed in the directory. Air-Conditioning and Refrigeration Institute member laboratories have the specialized facilities and trained manpower to make sound power measurements in a reverberant field.

Based on an American Society for Heating, Refrigerating and Air-Conditioning Engineers test method, the Air-Conditioning and Refrigeration Institute standards and the Certification Program have been developed. One standard is for rating and certification through independent laboratory tests of the sound-generating characteristics of air conditioning equipment and provides a uniform method for assigning a single rating number to this equipment. Most units rate between 1^{1/2} and 2^{1/2} on the Air-Conditioning and Refrigeration Institute rating scale. The rating has built into it a penalty for whines, screeches, and whistles -- the kind of noise that is disturbing but may not be adequately indicated by meter readings.

At random, over a 3 year period, each model of each manufacturer is retested by an independent laboratory to ensure the accuracy of the noise rating. Enforcement procedures are strict: if a unit is tested and found to be inaccurately rated, a manufacturer must change the sound rating, improve the unit to meet the original rating, or withdraw from the directory and thus lose the right to display the Air-Conditioning and Refrigeration Institute Sound Rating Seal of Certification on his units.

The Air-Conditioning and Refrigeration Institute has also developed an application standard which is basically a "cookbook" approach to converting the sound rating number into an expected A-weighted sound level that will be produced at given points of evaluation, e.g., the property line.

Another program that is of interest because of analogous problems to noise emission labeling is the voluntary labeling program which applies to energy-consuming home appliances[7-8]*. Figure 35 shows an example of the

*This program will be modified in the near future since the Energy Policy and Conservation Act (P.L. 94-163), which was passed on 22 December 1975, makes it mandatory for many products to be labeled as to their energy consumption. This program will be carried out by the Federal Energy Administration with the design of appropriate labels being the responsibility of the Federal Trade Commission.

energy guide

ASDF Corp. Model 5508A10

8,000 Btu per hour
(cooling capacity)

115 volts 860 watts 7.5 amperes

EER=9.3

Energy Efficiency Ratio expressed in Btu per watt-hour

IMPORTANT... for units with the same cooling capacity, higher EER means:
Lower energy consumption
Lower cost to use!

For available 7,500 to 8,500 Btu per hour 115 volt window models the EER range is

EER 5.4 to EER 9.9

For information on cost of operation and selection of correct cooling capacity, ask your dealer for NBS Publication LC 1053 or write to National Bureau of Standards, 411.00, Washington, D.C. 20234

Data on this label for this unit certified by

Tested in accordance with



Figure 41. Sample of the energy labels now found on many room air conditioners.

label to be affixed to a room air conditioner. The cooling capacity of a unit is determined, in accordance with an appropriate test procedure, in units of Btu per hour. The electrical power requirement is determined in units of watts. The efficiency of a unit is designated in terms of the Energy Efficiency Ratio (EER) which is the ratio of the cooling capacity to the electrical power requirement. The class interval is 0.1 Btu per watt-hour, obtained simply by rounding off the calculated ratio. Thus this is an absolute classification scheme in that the number on the label directly expresses a measure of the efficiency of the unit. The performance of a particular unit can be judged from the range of EER values shown on the label for available units of comparable cooling capacity. Thus this voluntary labeling program retains the benefits of an absolute classification scheme while at the same time giving some relative information.

Returning to noise emission, most acousticians who have been contacted by the authors believe that as a minimum, a label, or other documentation, should convey information as to the absolute noise emission. This can either be in terms of the designated noise emission, to whatever precision is reasonable, or in terms of a simple classification scheme such as the A-weighted sound power level rounded up to the nearest 0.5 B or 5 dB. (Note that such a rudimentary classification system involves division of the range of designations into intervals of "significant" size, but does not involve arbitrary coding). There seems to be very little reason to favor coding of an absolute classification scheme in any way (such as Class 1, 2, 3, ... or Class A, B, C, ...) that obscures the relationship to the actual noise emission.

There have been some proposals for relative classification schemes based on statistical distributions of noise emissions for a family of equipment. Difficulties with this type of system include the following:

- a particular model cannot be classified until essentially all other products in the same family have been measured. This makes one manufacturer too dependent upon the time schedules of other manufacturers.
- the classification of a product is sensitive to errors in the noise emission designations for other products in the same family.
- the classification scheme can be "manipulated" by catalog listings of particularly quiet or particularly noisy products, even though such products are not normally sold.
- the classification system changes with time so that one cannot readily compare products sold in different years.

It is recommended that serious consideration be given to a labeling system based on an absolute classification scheme, plus information on the range of noise emissions for competing products. This would be analogous to the energy guide label shown in Figure 35.

References for Appendix E

- [1] American National Standard Method for Rating the Sound Power Spectra of Small Stationary Noise Sources, S3.17-1975; also Acoust. Soc. Amer. Std. 4-1975 (American National Standards Institute, New York, 1975).
- [2] Lung, W. W., and Flynn, D. R., A Noise Emission Number for product designation, Noise Control Engineering 1, 108-113 (1975); errata in NCE 2, 3 (1975).
- [3] American National Standard Method for the Designation of Sound Power Emitted by Machinery and Equipment, S1.23-1976; also Acoust. Society Amer. Std. 5-1976 (American National Standards Institute, New York, 1976).
- [4] First Draft Proposal ISO/DP 4871 for Acoustics -- Noise Classification and Labelling of Equipment and Machinery, Document No. ISO/TC 43/SC 1 (Secretariat - 203) 274 (January 1976).
- [5] Coles, J. V., Standards and Labels for Consumer Goods (Ronald Press Co., New York, 1949).
- [6] Dickerson, F. R., Product Safety in Household Goods (Bobbs-Merrill Co., New York, 1968).
- [7] Air conditioner labels show how to keep coolant for least \$, Commerce Today, Vol. IV, No. 18, pp 10-11 (June 10, 1974).
- [8] Conserving Energy Through Appliance Labeling, Dimensions/NBS 50, 224-225 & 230 (1974).

SECRET AVIAN ADIC 00000

NBS-114A (REV. 7-73)

U.S. DEPT. OF COMM. BIBLIOGRAPHIC DATA SHEET		1. PUBLICATION OR REPORT NO. NBS 113-122 and EPA 550/9-77-101	2. Gov't Accession No.	3. Recipient's Accession No.
4. TITLE AND SUBTITLE Noise Emission Measurements for Regulatory Purposes			5. Publication Date March 1977	6. Performing Organization Code
7. AUTHOR(S) D. R. Flynn, W. A. Leasure, Jr., A. I. Rubin, M. A. Cadoff			8. Performing Organ. Report No.	
9. PERFORMING ORGANIZATION NAME AND ADDRESS NATIONAL BUREAU OF STANDARDS DEPARTMENT OF COMMERCE WASHINGTON, D. C. 20234			10. Project/Task/Work Unit No.	
12. Sponsoring Organization Name and Complete Address (Street, City, State, ZIP) U. S. Environmental Protection Agency Office of Noise Abatement and Control Washington, D. C. 20460			11. Contract/Grant No.	
			13. Type of Report & Period Covered Final	
14. Sponsoring Agency Code			15. SUPPLEMENTARY NOTES Library of Congress Catalog Card Number: 76-608406	
16. ABSTRACT (A 200-word or less factual summary of most significant information. If document includes a significant bibliography or literature survey, mention it here.) A review is given of the measurement needs attendant to regulation of the noise generated and emitted by commercial products. The emphasis is primarily on measurement procedures for use in conjunction with point-of-sale regulations as opposed to regulations on the noise which a source actually emits when in operation. The report is divided into three major parts. Part I is a discussion of overall measurement requirements and the type of data and information which are needed in order to promulgate regulations based on appropriate measurement techniques. Part II is designed as a checklist for the evaluation of the suitability of a noise measurement standard for a particular class of products or, in the absence of a suitable standard, as a framework for development of one. The intent is to identify and discuss in some detail those factors which can impact on the accuracy, precision, and applicability of a noise measurement process. Part III consists of a series of flow charts depicting the development of appropriate procedures for the measurement of product noise emission.				
17. KEY WORDS (Use to twelve entries; alphabetical order; capitalize only the first letter of the first key word unless a proper name; separated by semicolon) Acoustics; environmental pollution; machinery and equipment; noise; noise abatement and control; noise emission; regulation; sound.				
18. AVAILABILITY		<input checked="" type="checkbox"/> Unlimited	19. SECURITY CLASS (THIS REPORT) UNCLASSIFIED	21. NO. OF PAGES 193
<input type="checkbox"/> For Official Distribution. Do Not Release to NTIS		<input checked="" type="checkbox"/> Order From Sup. of Doc., U.S. Government Printing Office Washington, D.C. 20401, <u>SD Cat. No. C11-111172</u>	20. SECURITY CLASS (THIS PAGE) UNCLASSIFIED	22. Price \$2.60
<input type="checkbox"/> Order From National Technical Information Service (NTIS) Springfield, Virginia 22151				

USCOMPHDC 28042-874

NBS TECHNICAL PUBLICATIONS

PERIODICALS

JOURNAL OF RESEARCH reports National Bureau of Standards research and development in physics, mathematics, and chemistry. It is published in two sections, available separately:

• **Physics and Chemistry (Section A)**

Papers of interest primarily to scientists working in these fields. This section covers a broad range of physical and chemical research, with major emphasis on standards of physical measurement, fundamental constants, and properties of matter. Issued six times a year. Annual subscription: Domestic, \$17.00; Foreign, \$21.25.

• **Mathematical Sciences (Section B)**

Studies and compilations designed mainly for the mathematician and theoretical physicist. Topics in mathematical statistics, theory of experiment design, numerical analysis, theoretical physics and chemistry, logical design and programming of computers and computer systems. Short numerical tables. Issued quarterly. Annual subscription: Domestic, \$9.00; Foreign, \$11.25.

DIMENSIONS/NBS (Formerly Technical News Bulletin)—This monthly magazine is published to inform scientists, engineers, businessmen, industry, teachers, students, and consumers of the latest advances in science and technology, with primary emphasis on the work at NBS. The magazine highlights and reviews such issues as energy research, fire protection, building technology, metric conversion, pollution abatement, health and safety, and consumer product performance. In addition, it reports the results of Bureau programs in measurement standards and techniques, properties of matter and materials, engineering standards and services, instrumentation, and automatic data processing.

Annual subscription: Domestic, \$12.50; Foreign, \$15.65.

NONPERIODICALS

Monographs—Major contributions to the technical literature on various subjects related to the Bureau's scientific and technical activities.

Handbooks—Recommended codes of engineering and industrial practice (including safety codes) developed in cooperation with interested industries, professional organizations, and regulatory bodies.

Special Publications—Include proceedings of conferences sponsored by NBS, NBS annual reports, and other special publications appropriate to this grouping such as wall charts, pocket cards, and bibliographies.

Applied Mathematics Series—Mathematical tables, manuals, and studies of special interest to physicists, engineers, chemists, biologists, mathematicians, computer programmers, and others engaged in scientific and technical work.

National Standard Reference Data Series—Provides quantitative data on the physical and chemical properties of materials, compiled from the world's literature and critically evaluated. Developed under a world-wide program coordinated by NBS. Program under authority of National Standard Data Act (Public Law 90-300).

BIBLIOGRAPHIC SUBSCRIPTION SERVICES

The following current-awareness and literature-survey bibliographies are issued periodically by the Bureau: **Cryogenic Data Center Current Awareness Service**. A literature survey issued biweekly. Annual subscription: Domestic, \$20.00; Foreign, \$25.00. **Liquidified Natural Gas**. A literature survey issued quarterly. Annual subscription: \$20.00.

NOTE: At present the principal publication outlet for these data is the *Journal of Physical and Chemical Reference Data (JPCRD)* published quarterly for NBS by the American Chemical Society (ACS) and the American Institute of Physics (AIP). Subscriptions, reprints, and supplements available from ACS, 1165 Sixteenth St. N.W., Wash. D. C. 20056.

Building Science Series—Disseminates technical information developed at the Bureau on building materials, components, systems, and whole structures. The series presents research results, test methods, and performance criteria related to the structural and environmental functions and the durability and safety characteristics of building elements and systems.

Technical Notes—Studies or reports which are complete in themselves but restrictive in their treatment of a subject. Analogous to monographs but not so comprehensive in scope or definitive in treatment of the subject area. Often serve as a vehicle for final reports of work performed at NBS under the sponsorship of other government agencies.

Voluntary Product Standards—Developed under procedures published by the Department of Commerce in Part 10, Title 15, of the Code of Federal Regulations. The purpose of the standards is to establish nationally recognized requirements for products, and to provide all concerned interests with a basis for common understanding of the characteristics of the products. NBS administers this program as a supplement to the activities of the private sector standardizing organizations.

Consumer Information Series—Practical information, based on NBS research and experience, covering areas of interest to the consumer. Easily understandable language and illustrations provide useful background knowledge for shopping in today's technological marketplace.

Order above NBS publications from: Superintendent of Documents, Government Printing Office, Washington, D.C. 20402.

Order following NBS publications—NBSIR's and NBS from the National Technical Information Service, Springfield, Va. 22161.

Federal Information Processing Standards Publications (FIPS PUBS)—Publications in this series collectively constitute the Federal Information Processing Standards Register. Register serves as the official source of information in the Federal Government regarding standards issued by NBS pursuant to the Federal Property and Administrative Services Act of 1949 as amended, Public Law 80-306 (70 Stat. 1127), and as implemented by Executive Order 11717 (38 FR 12316, dated May 11, 1973) and Part 6 of Title 15 CFR (Code of Federal Regulations).

NBS Interagency Reports (NBSIR)—A special series of interim or final reports on work performed by NBS for outside sponsors (both government and non-government). In general, initial distribution is handled by the sponsor; public distribution is by the National Technical Information Service (Springfield, Va. 22161) in paper copy or microfiche form.

Superconducting Devices and Materials. A literature survey issued quarterly. Annual subscription: \$20.00. Send subscription orders and remittances for the preceding bibliographic services to National Bureau of Standards, Cryogenic Data Center (275.02) Boulder, Colorado 80302.

U.S. DEPARTMENT OF COMMERCE
National Bureau of Standards
Washington, D.C. 20234

OFFICIAL BUSINESS

Penalty for Private Use, \$300

POSTAGE AND FEES PAID
U.S. DEPARTMENT OF COMMERCE
COM-218



SPECIAL FOURTH CLASS RATE
BOOK