

N-96-01  
II-A-06

NBSIR 73-417  
EPA-550/9-73-007

# Evaluation of Commercial Integrating-Type Noise Exposure Meters

William A. Leasure, Jr.  
Ronald L. Fisher  
Marilyn A. Cadoff

NATIONAL BUREAU OF STANDARDS

December 1973

Joint EPA/NBS Study



Approved for public release; distribution unlimited

Applied Acoustics Section  
Mechanics Division  
Institute for Basic Standards  
National Bureau of Standards  
Washington, D. C. 20234

1973-12-14 10:10 AM

ERRATUM:

NBSIR 73-417, EPA-550/9-73-007

Replace Figure 4.1-3, page 10, with figure below:

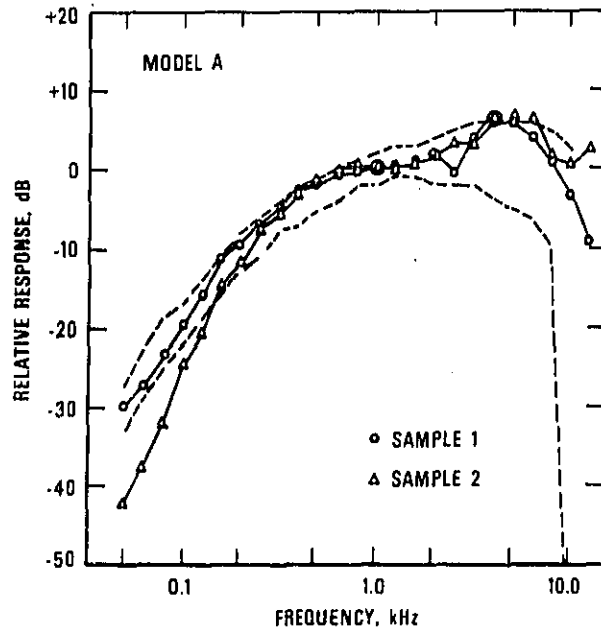

Replace Figure 4.2-3, page 13, with figure below:

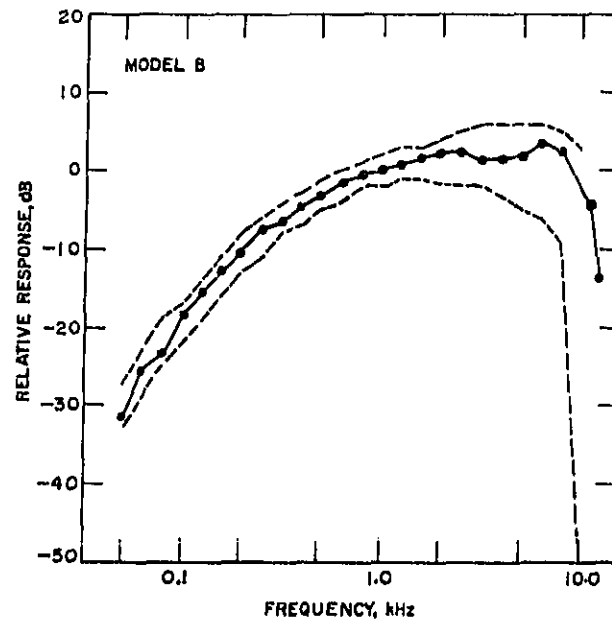

NBSIR 73-417  
EPA-550/9-73-007

**EVALUATION OF COMMERCIAL INTEGRATING-  
TYPE NOISE EXPOSURE METERS**

---

*William A. Leasure, Jr., Ronald L. Fisher, and Marilyn A. Cadoff*

Applied Acoustics Section  
Mechanics Division  
Institute for Basic Standards  
National Bureau of Standards  
Washington, D. C. 20234

December 1973

Final Report

Prepared for  
Office of Noise Abatement and Control  
U. S. Environmental Protection Agency  
Washington, D. C. 20460



---

U. S. DEPARTMENT OF COMMERCE, Frederick B. Dent, Secretary  
NATIONAL BUREAU OF STANDARDS, Richard W. Roberts, Director

#### ABSTRACT

As a result of the promulgation of occupational noise exposure regulations by the Federal government, there are a number of commercial noise exposure meters on the market today that provide a measure of noise integrated (with appropriate weighting) over a time interval. This report presents the results of an evaluation of such instruments by the National Bureau of Standards (under the sponsorship of the U. S. Environmental Protection Agency) as to their usefulness in monitoring compliance with occupational noise regulations as well as their applicability as instruments for use in achieving the broader goals of the EPA. Tests were designed and conducted to evaluate microphone and system response to sound of random incidence, frequency response, crest factor capability, accuracy of the exchange rate circuitry, performance of the noise exposure meter as a function of temperature, and the dependence of the device on battery voltage. The rationale of the test procedures utilized to evaluate overall system as well as specific performance attributes, details of the measurement techniques, and results obtained are discussed.

Key words: Acoustics, (sound); dosimeter; environmental acoustics; instrumentation; noise exposure; noise exposure meters.

TABLE OF CONTENTS

1. Introduction . . . . .	1
2. Functional Operation of Noise Exposure Meters . . . . .	1
3. Description of Tests . . . . .	3
3.1. Acoustical Tests . . . . .	5
a. Microphone Calibration . . . . .	6
b. System Response . . . . .	6
3.2. Electrical Tests . . . . .	6
a. Frequency Response . . . . .	6
b. Crest Factor Capability . . . . .	7
c. Exchange Rate . . . . .	8
d. Temperature Response . . . . .	8
e. Battery Voltage . . . . .	8
3.3. General Observations . . . . .	8
4. Results of Test . . . . .	8
4.1. Model A . . . . .	8
4.1.1. Acoustical Tests . . . . .	8
a. Microphone Calibration . . . . .	8
b. System Response . . . . .	8
4.1.2. Electrical Tests . . . . .	9
a. Frequency Response . . . . .	9
b. Crest Factor Capability . . . . .	10
c. Exchange Rate . . . . .	10
d. Temperature Range . . . . .	10
e. Battery Voltage . . . . .	10
4.1.3. General Observations . . . . .	11
4.2. Model B . . . . .	12
4.2.1. Acoustical Tests . . . . .	12
a. Microphone Calibration . . . . .	12
b. System Response . . . . .	12
4.2.2. Electrical Tests . . . . .	12
a. Frequency Response . . . . .	12
b. Crest Factor Capability . . . . .	12
c. Exchange Rate . . . . .	14
d. Temperature Range . . . . .	13
e. Battery Voltage . . . . .	15
4.2.3. General Observations . . . . .	15
4.3. Model C . . . . .	15
4.3.1. Acoustical Tests . . . . .	15
a. Microphone Calibration . . . . .	15
b. System Response . . . . .	15
4.3.2. Electrical Tests . . . . .	16
a. Frequency Response . . . . .	16
b. Crest Factor Capability . . . . .	16

c.	Exchange Rate . . . . .	16
d.	Temperature Range . . . . .	16
e.	Battery Voltage . . . . .	16
4.3.3.	General Observations . . . . .	16
4.4.	Model D . . . . .	18
4.4.1.	Acoustical Tests . . . . .	18
a.	Microphone Calibration . . . . .	18
b.	System Response . . . . .	18
4.4.2.	Electrical Tests . . . . .	18
a.	Frequency Response . . . . .	18
b.	Crest Factor Capability . . . . .	18
c.	Exchange Rate . . . . .	21
d.	Temperature Range . . . . .	21
e.	Battery Voltage . . . . .	21
4.4.3.	General Observations . . . . .	21
4.5.	Model E . . . . .	21
4.5.1.	Acoustical Tests . . . . .	21
a.	Microphone Calibration . . . . .	21
b.	System Response . . . . .	22
4.5.2.	Electrical Tests . . . . .	23
a.	Frequency Response . . . . .	23
b.	Crest Factor Capability . . . . .	23
c.	Exchange Rate . . . . .	23
d.	Temperature Range . . . . .	23
e.	Battery Voltage . . . . .	24
4.5.3.	General Observations . . . . .	25
4.6.	Model F . . . . .	25
4.6.1.	Acoustical Tests . . . . .	25
4.6.2.	Electrical Tests . . . . .	25
4.6.3.	General Observations . . . . .	25
4.7.	Model G . . . . .	26
4.7.1.	Acoustical Tests . . . . .	26
4.7.2.	Electrical Tests . . . . .	26
4.7.3.	General Observations . . . . .	26
4.8.	Model H . . . . .	26
4.8.1.	Acoustical Tests . . . . .	26
4.8.2.	Electrical Tests . . . . .	27
4.8.3.	General Observations . . . . .	27
5.	Summary and Conclusions . . . . .	28
6.	Bibliography . . . . .	29

## EVALUATION OF COMMERCIAL INTEGRATING-TYPE NOISE EXPOSURE METERS

by

William A. Leasure, Jr., Ronald L. Fisher, and Marilyn A. Cadoff

### 1. INTRODUCTION

As part of its present and anticipated responsibility for monitoring and controlling noise, the Environmental Protection Agency, Office of Noise Abatement and Control, has a need to develop and disseminate technical information on the levels and durations of noise to which individuals are directly exposed.

Present Federal regulations, promulgated under the authority of the Occupational Safety and Health Act and the Coal Mine Safety Act, set definite limits on the noise exposure of workers during their 8-hour working day. The intent of these regulations is to reduce the risk of permanent noise-induced hearing damage.

In order to comply with these regulations, it is necessary to determine an individual's noise exposure for work environments that have A-weighted-noise levels of 90 dB or higher. The conventional method of determining an individual's noise exposure is to use a sound level meter in conjunction with a detailed time-and-motion study and then calculate the cumulative noise exposure.

Whether an observer armed with a stop watch and a sound level meter can accurately characterize the noise "dose" to which a worker has been exposed is a debatable question. For constant noise sources and fixed operator locations, no problem exists. For the roving worker, however, and the worker who functions in a fluctuating noise environment, it is difficult to observe their noise exposure and to compute an accurate daily noise exposure. This measurement approach is expensive and time-consuming and is generally inaccurate due to the approximations in the time-and-motion study that practicality dictates.

The promulgation of occupational noise exposure regulations by the Federal government has resulted in a proliferation on the market of new sound level meters and, to a lesser extent, noise exposure meters, or dosimeters, which provide a measure of noise level integrated, with appropriate weighting, over a time interval. Because of the motivation for production of these devices, most of them now being manufactured cover only the range from 90 to 115 dB.

At present there are no standard performance specifications for such integrating noise exposure meters. For this reason, the National Bureau of Standards, under the sponsorship of the Environmental Protection Agency, conducted a research program to evaluate some available existing noise exposure meters -- both acoustically and electrically -- as to their usefulness in monitoring compliance with the OSHA noise exposure regulations and/or carrying out the broader goals of EPA, including determination of the average individual daily noise exposure of persons in different living patterns.

### 2. FUNCTIONAL OPERATION OF NOISE EXPOSURE METERS

Section 1910.95, Occupational Noise Exposure, of the U. S. Department of Labor Occupational Safety and Health Standards (Federal Register, Part II, Vol. 37, No. 202, October 18, 1972) includes the following:

"(a) Protection against the effects of noise exposure shall be provided when the sound levels exceed those shown in Table G-16 when measured on the A scale of a standard sound level meter at slow response .....

(b) (1) When employees are subjected to sound exceeding those listed in Table G-16, feasible administrative or engineering controls shall be utilized. If such controls fail to reduce sound levels within the levels of Table G-16, personal protective equipment shall be provided and used to reduce sound levels within the levels of the table.

(2) If the variations in noise level involve maxima at intervals of 1 second or less, it is to be considered continuous.

(3) In all cases where the sound levels exceed the values shown herein, a continuing, effective hearing conservation program shall be administered.

TABLE G-16 PERMISSIBLE NOISE EXPOSURES<sup>1</sup>

Duration per day, hours	Sound level dBA slow response
8.....	90
6.....	92
4.....	95
3.....	97
2.....	100
1 1/2.....	102
1.....	105
1/2.....	110
1/4 or less.....	115

<sup>1</sup>When the daily noise exposure is composed of two or more periods of noise exposure of different levels, their combined effect should be considered, rather than the individual effect of each. If the sum of the following fractions:  $C_1/T_1 + C_2/T_2 + \dots + C_n/T_n$  exceeds unity, then, the mixed exposure should be considered to exceed the limit value.  $C_n$  indicates the total time of exposure at a specified noise level, and  $T_n$  indicates the total time of exposure permitted at that level.

Exposure to impulsive or impact noise should not exceed 140 dB peak sound pressure level."

The permitted durations, T, shown in the above table can be described by the formula

$$t = \frac{8}{2(L_{eq} - 90)/5}, \quad (1)$$

where t is expressed in hours and  $L_{eq}$  is the equivalent noise level, expressed in decibels re 20μPA.

In general, the equivalent noise level of a time-varying signal of duration T is

$$L_{eq} = 10 \log_{10} \left[ \frac{1}{T} \int_0^T (10^{L/10})^{3/n} dt \right]^{n/3}, \quad (2)$$

where L is the time-varying sound level and n defines an exchange rate between noise level and time. For instruments using energy equivalence,  $n = 3$ , corresponding to a rate of 3.01 decibels per doubling of time. Present U. S. hearing conservation regulations (Table G-16 and eq. (1)) use an exchange rate of  $n = 4.98$ , corresponding to a rate of 5 decibels per doubling of time.

The equivalent duration of time-varying signal of actual duration T is

$$t_{eq} = \int_0^T \left[ 10^{(L-L_r)/10} \right]^{3/n} dt, \quad (3)$$

where  $L_r$  is the rating sound level.<sup>1/</sup> For OSHA regulations,  $L_r = 90$  dB.

The percent of allowable noise exposure is

$$PE = 100 \cdot \frac{1}{t_r} \int_0^T \left[ 10^{(L-L_r)/10} \right]^{3/n} dt, \quad (4)$$

<sup>1/</sup>The relation between eqs. (2) and (5) is seen by observing that  $(10^{L/10})^{3/n} = (10^{L/10})^{3/4.98} = (10 \cdot 301)^{L/5} = 2^{L/5}$ .



where  $t_r$  is the rating duration. Substituting the OSHA rating duration of 8 hr, the rating sound level of 90 dB, and  $n = 4,98$ , this becomes

$$\begin{aligned}
 PE &= 12.5 \int_0^T \left[ 10^{(L-90)/10} \right]^{.602} dt \\
 &= 12.5 \int_0^T 2^{(L-90)/5} dt
 \end{aligned} \tag{5}$$

Thus if  $L$  equals 90 dB, one will acquire 12.5% of the allowable noise exposure during each hour exposed and the total allowable exposure in 8 hours. If  $L$  equals 95 dB, 25% is acquired each hour so that only four hours of exposure are permitted.

All of the U. S.-made personal integrating-type noise exposure meters investigated purported to measure the quantity defined in eq. (5). Because of the wording of present Federal regulations the devices intentionally do not include levels below 90 dB in the integration. In addition to measuring percentage of allowable noise exposure, some of the devices provide a means of indicating whether or not the sound level exceeded 115 dB during the measurement interval.

There has been some ambiguity as to the interpretation of Table G-16 in the OSHA regulations. One stationary (non-wearable) integrating noise exposure meter did not follow eq. (5) but, rather, followed the steps in Table G-16. That is, the percent of allowable exposure was computed from

$$PE = 100 \sum_n \frac{C_n}{T_n} \tag{6}$$

where  $C_n$  indicates the total time of exposure in a specified range of noise level and  $T_n$  indicates the total time of exposure permitted at that level. Thus  $T_1 = 8$  hr corresponds to levels in the range 90-92 dB,  $T_2 = 6$  hr corresponds to 92-95 dB, etc.

Some devices did not measure noise exposure. The simplest of these caused a warning light to be turned on when the noise level exceeded a particular value. One device measured the total time that a particular noise level was exceeded. One device, of European manufacture, did not provide information compatible with OSHA regulations. Such devices are not included in this report.

Basically, a noise exposure meter consists of two parts: a sound level metering section and an integrating section. A block diagram showing the principal of operation for a typical dosimeter is shown in Figure 1. A microphone (most devices utilize an omnidirectional ceramic microphones) senses the sound pressure and the output is fed into an A-weighting filter which appropriately attenuates the signal. The signal is then detected and averaged to provide an output hopefully equivalent to the rms A-weighted slow response value that would be read on a sound level meter.

The output of the sound level metering section is then fed into an integrator section which performs the integration indicated in eq. (5). The output of the exponent circuit (a voltage) is typically converted to a frequency (pulses), or in the case of the devices that utilize an electrochemical memory cell, to a current. The pulse count is accumulated, then monitored and when a given percent of the allowable exposure is reached -- for example, one-tenth of one percent -- a signal is sent to the counter and the readout display registers one-tenth percent.

In addition, most devices have a detector which monitors the signal for A-weighted noise in excess of 115 dB. If such a noise is detected, an electronic latch is tripped. The latch is attached to an indicating light and by closing the circuit with a test button, its status can be checked.

### 3. DESCRIPTION OF TESTS

The primary goal of this program was the evaluation of commercial noise exposure meters as to their applicability as instruments for use in achieving the broader goals of EPA rather than their usefulness in monitoring compliance with occupational noise regulations. Therefore, the study included testing of specific performance attributes in addition to overall systems tests. Well-defined electrical and acoustical signals were provided to each device and the response of the instrument was compared with the known input. It was felt that the following factors required attention:

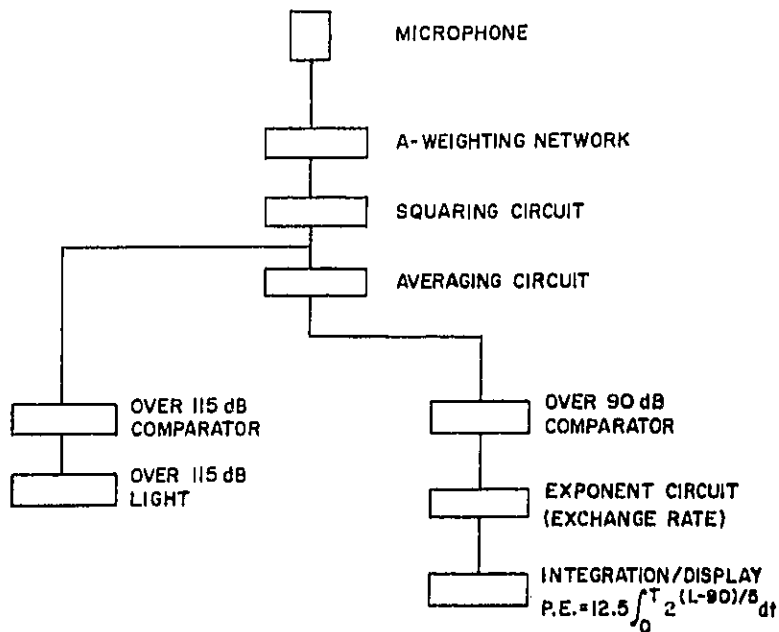

Figure 1. Block diagram showing the principle of operation for a typical noise exposure meter.

Acoustical Evaluation

- microphone response to sound of random incidence
- errors or uncertainties due to reflection, diffraction, and absorption effects arising from use conditions
- overall system response to sound of random incidence

Electrical Evaluation

- frequency response
- detector characteristics (i.e., how true is rms response?)
- dynamic response for time varying signals
- dynamic range (including internal noise and distortion)
- nature and accuracy of time integration

Overall Evaluation

- appropriateness of quantity measured
- convenience of use
- ease and accuracy of calibration
- sensitivity to environment
- durability

It would have been prohibitively expensive and time consuming to conduct detailed calibrations and physical tests to evaluate all of the quantities listed above. Therefore, the manufacturer's instruction manual and wiring diagrams were carefully studied to ensure that the operation of the device was fully understood and that test signals were applied and sampled at appropriate locations. On this basis, carefully selected tests were carried out to yield the most important information regarding the performance of each noise exposure meter. The following sections contain detailed descriptions of the various tests -- both acoustical and electrical -- which were performed.

### 3.1. Acoustical Tests

Acoustical tests were performed in a 425 m<sup>3</sup> reverberation chamber. For A-weighted-sound levels at and below 100 dB, the input signal was broad-band noise shaped to be "pink"<sup>2/</sup> from 50 kHz to 10 kHz. Above 100 dB an octave band of pink noise centered at 1 kHz was utilized.

Microphone and speaker placement as well as the signal generation and data retrieval system utilized for acoustical tests are shown in Figure 2.

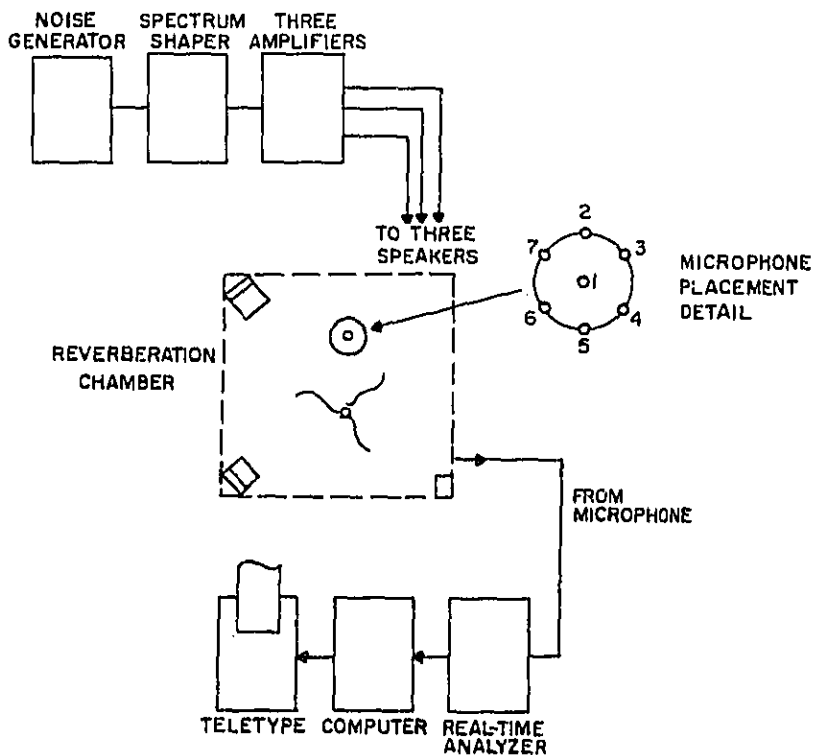

Figure 2. Block diagram of equipment used for acoustic tests in a reverberation chamber.

<sup>2/</sup> "pink" noise is white noise passed through a network which weights at -3 dB per octave.

Sound pressure levels were measured using a one-inch condenser microphone.

For all tests the vanes in the chamber were rotated at 5 r.p.m. to promote diffuseness of the sound field.

#### a. Microphone Calibration

During microphone calibration the reference microphone was located at position 1 (see Figure 2) and noise exposure meter microphones (test microphones) occupied the remaining six positions on the circumference of a two-foot diameter circle surrounding the standard microphone. All microphones were located five feet above the floor.

The noise exposure meter microphones had been removed from the devices. Care was taken to maintain microphone cable length. The signal from each test microphone was fed into a preamplifier and then into a one-third octave band real-time analyzer.

The sound level of the pink noise was adjusted to read 100 dB on the A scale of the real-time analyzer. Other sound levels were utilized to check the linearity of the microphones over the range of interest (90-115 dB).

Once the response of the measuring system -- reference microphone, preamplifiers and real-time analyzer -- had been set utilizing a pistonphone and the sound field established, the calibration was placed under computer control. The one-third octave band correction values based on electrostatic actuator calibration of the reference microphone were stored in the computer. The computer was programmed such that signals from the reference microphone were interrogated 120 seconds (approximately 6 time constants in the slow-random mode of the real-time analyzer) after the onset of the sound fields. Addition of the correction values and the response of the reference microphone to the sound field resulted in the establishment of the desired one-third octave band sound pressure levels in the room. In sequence each of the test microphones were interrogated in a similar manner. Using these data, the computer calculated the response of each test microphone.

#### b. System Response

For system response testing, the microphone of each noise exposure meter was positioned on the circumference of a two-foot diameter circle which surrounded the reference microphone. All microphones were located five feet above the floor. The response of the measuring system was set with a pistonphone (124 dB at 250 Hz), the desired sound field was established, and the sound field was turned off. Once all of the noise exposure meters were turned on and zeroed, the sound field was turned on, at the established level, for a time equivalent to 75% of the permissible noise exposure under OSHA regulations. This was chosen rather than 100% since one device would not indicate overranging above 100%. Upon completion of the appropriate time period, as monitored by a stop watch, the sound field was turned off and the noise exposure meter readings were recorded. This procedure was utilized for sound fields of 92, 95, 100, 105, 110 and 115 dB.

### 3.2. Electrical Tests

In this section, descriptions are given of the various tests which were carried out to determine specific attributes of device performance.

For these tests an electrical signal was inserted in series with the microphone. A signal generator with a low output impedance, compared to the impedance of the microphone, was used to ensure that the total input impedance to the electronics was essentially the same as in normal usage.

In principle, all of these tests could be performed using the readout device provided with the noise exposure meter. However, because of the large quantity of data being acquired this would have been prohibitively time-consuming. Accordingly, for one of the tests (see 3.2.a.), voltage measurements were made at an internal point in the instrument. For other tests, direct measurements were made of the period of the pulse train which advanced the counter (mechanical or electronic) in the noise exposure meter. In many cases, a fairly high frequency pulse train was available (with a dividing circuit to produce a lower frequency signal to actuate the counter) so that the time to obtain a datum point was reduced from possibly hours to the few seconds needed for the system to stabilize after changing the input signal.

#### a. Frequency Response

The frequency response was measured by injecting a sine wave voltage in series with the microphone and then measuring the voltage at the output of the A-weighting network while the frequency of the test signal was swept over the frequency range from 20 Hz to 20 kHz. The frequency response was recorded directly on a graphic level recorder which had its paper speed synchronized with the oscillator sweep speed.

The frequency response of the electronics was combined with that of the microphone (see 3.1.4.), to obtain the overall frequency response curves shown in Section 4.

#### b. Crest Factor Capability

A pulsed sine wave was presented to the noise exposure meter via the voltage insertion technique to obtain a measurement of the crest factor handling capability. The crest factor of a signal is defined as the ratio of peak signal value to rms (root-mean-square) value. It is important to consider because many industrial noises have a high crest factor.

The pulsed sine wave consisted of a 1 kHz sine wave gated by a pulse train with a frequency of 100 Hz (period = 10.0 ms) and an adjustable pulse duration. By changing the pulse duration from full-on to a very short pulse (12.5 ms), the crest factor was increased from 1.414 (sine wave) to 4.0. As the pulse duration was decreased, the pulse amplitude was increased in order to maintain a constant rms voltage. The rms voltage levels applied were those corresponding to the 114 dB and 95 dB levels for the individual noise exposure meters.

The equipment setup is shown in Figure 3. The gating of the sine wave was accomplished using an analog multiplier. A precision ac voltmeter (accurate for signals having a crest factor up to 10) was used to measure the rms value of the pulsed sine wave. An oscilloscope was used to measure peak values. The response of the noise exposure meter was determined either by measuring the period of the pulse train which actuated the counter or by using the actual readout from the noise exposure meter.

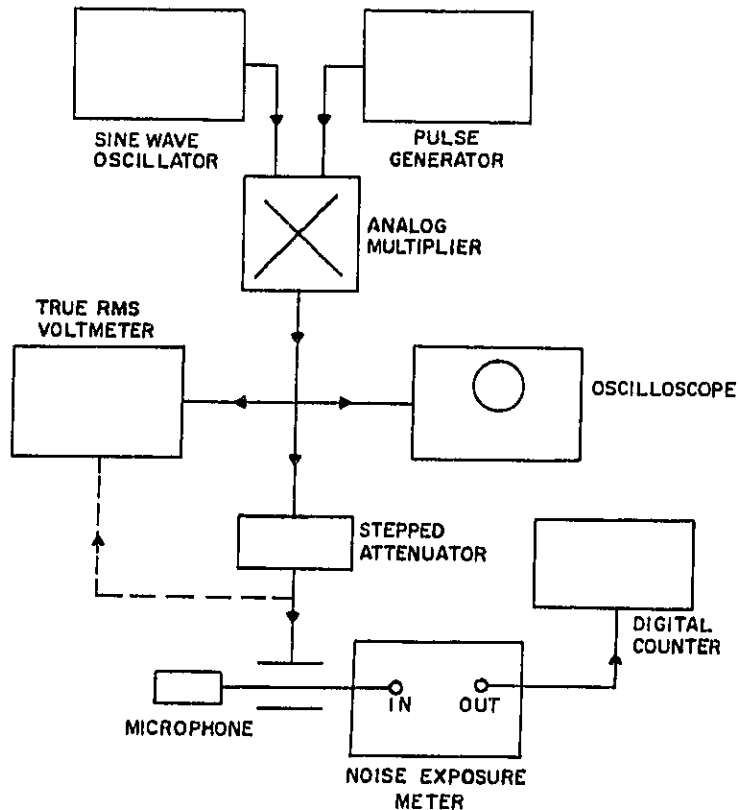

Figure 3. Block diagram of the equipment used for crest factor measurements.

#### c. Exchange Rate

Using the voltage insertion technique, a 1 kHz sine wave was injected in series with the microphone and the response of the noise exposure meter observed (either directly or by observing the internal pulse train) as the voltage was varied over a range corresponding approximately to a sound level of 90 to 115 dB.

The data -- hours for 100% exposure vs. the input voltage level (i.e., vs. the logarithm of voltage) -- were plotted and a straight line was drawn through the central portion (main trend) of the data. The voltage corresponding to an allowable exposure time of 0.25 hr was then read from this curve. Using this voltage in an expression analogous to eqs. (4) and (5) in Section 2, calculations were made of the percent of allowable noise exposure which the device would be expected to read for each test voltage provided it were functioning perfectly. The observed readings (actual data points) were then ratioed to the calculated expected readings. In effect, this procedure compares the response of the device at any test voltage to the response which would be expected if the device (1) were functioning perfectly at a voltage corresponding to a noise level of 115 dB and (2) had exactly the correct exchange rate of 5 decibels for a doubling of exposure time.

#### d. Temperature Response

Since personal noise exposure meters may be used in occupations where temperature extremes occur, limited measurements were made of performance as a function of temperature.

A 1 kHz signal was injected in series with the microphone and the output of the noise exposure meter measured with the device at room temperature (24°C), in a small oven at 45±1°C, and in a refrigerator at 5±1°C. The instruments were allowed to reach thermal equilibrium before data were taken.

#### e. Battery Voltage

Personal integrating noise exposure meters are battery operated and during normal usage the battery voltage will decrease. To determine the dependence of the dosimeter on battery voltage, an adjustable dc power supply was substituted for the internal battery. The voltage was adjusted over a wide range appropriate for the battery type (in a specific voltage range given by the manufacturer) while injecting a 1 kHz signal in series with the microphone. Thus the performance of the instrument was determined as a function of supply voltage. Most of the devices had a voltage regulator and a battery check feature to indicate when the battery voltage was too low for proper operation. When these features were functioning properly, the tests indicated that low battery voltage would not result in erroneous measurements unless the battery was sufficiently discharged to deactivate the battery check indicator. For one instrument, however, readings of noise exposure were found to be significantly in error before the battery check indicator revealed a problem. For this instrument the performance is reported at the voltage which deactivated the battery check indicator.

### 3.3. General Observations

In addition to the specific acoustical and electrical tests described above, observations were made relative to the convenience of use and to factors which could lead to maintenance or operational difficulties. These observations are listed in Section 4 for each instrument evaluated.

## 4. RESULTS OF TEST

In this Section, results are given for the tests described in Section 3. The test samples included the following commercial noise exposure meters: Columbia models 101 and 104, Dupont, General Radio models 1934 and 1944, 3M, Quest M-6, and Tracoustics. Unless otherwise indicated, two samples of each model were tested. All of the models tested were purchased between March and May, 1972; therefore, present models may not be identical to those tested due to possible modifications by the manufacturer.

### Personal (Wearable) Instruments

#### 4.1. Model A

##### 4.1.1. Acoustical Tests

###### a. Microphone Calibration

The relative response of the microphone based on 0 dB response at 1 kHz, is shown as a function of frequency in Figure 4.1-1. Tests over the range of A-weighted-sound levels from 90 to 115 dB indicated no problems with linearity.

###### b. System Response

The overall performance of the noise exposure meter, when placed in a random, diffuse sound field as described in Section 3.1.b, is shown in Figure 4.1-2. The response was measured relative to a

calibrated condenser microphone and measurement system. The cross-hatched region indicates the estimated uncertainty (95 percent confidence limits) in the level of the sound field in which the noise exposure meter was tested.

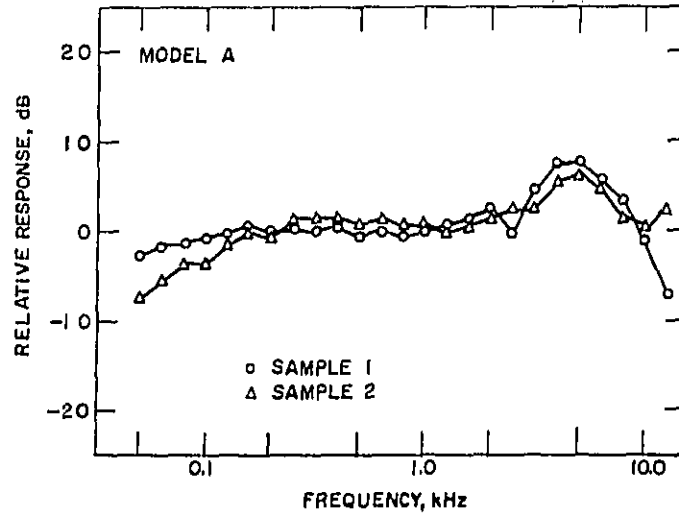

Figure 4.1-1. Relative frequency response of microphone.

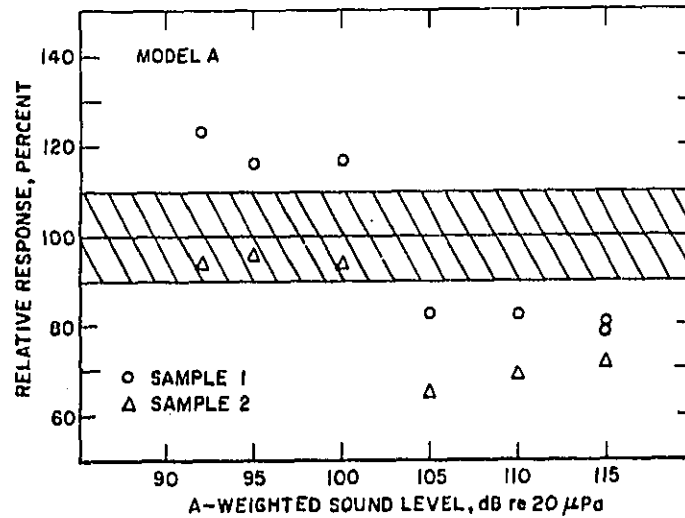

Figure 4.1-2. Response of noise exposure meter, relative to expected response when placed in a field of pink noise (see text) at A-weighted-sound levels from 92 to 115 dB.

#### 4.1.2. Electrical Tests

##### a. Frequency Response

The combined frequency response of the microphone, the input amplifier, and the A-weighting network, as measured at the output of the A-weighting network, is shown in Figure 4.1-3.

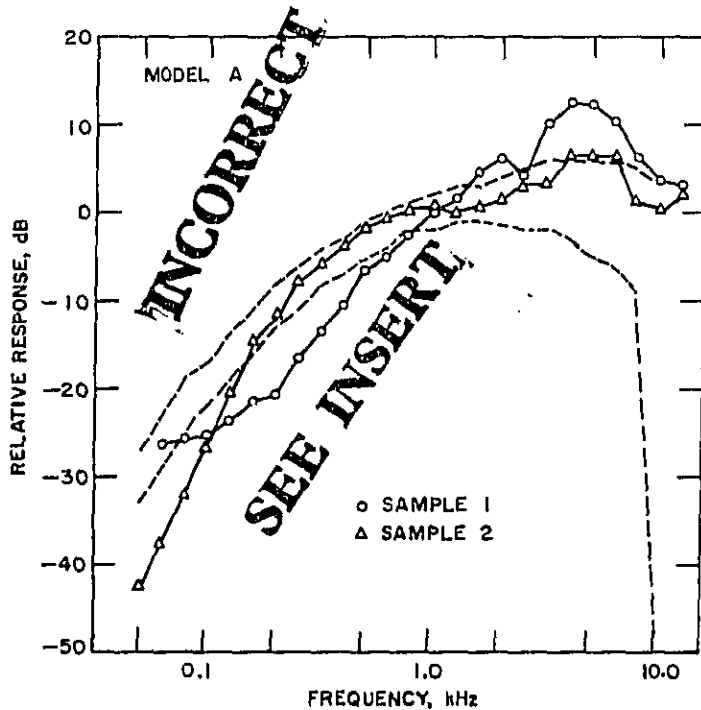

Figure 4.1-3. Relative combined frequency response of microphone plus electronics. The dashed curves indicate the allowable response level limits for a Type 2 sound level meter as specified in American National Standard Specifications for Sound Level Meters, S1.4-1971.

b. Crest Factor Capability

The response of the noise exposure meter, normalized to 100% for a crest factor of 1.414 (sine wave), is shown in Figure 4.1-4. as a function of the crest factor (ratio of peak voltage to rms voltage) of the test signal.

c. Exchange Rate

The response of the noise exposure meter, normalized to 100% at a duration of 0.25 hours, relative to the response of an instrument with an exchange rate of exactly 5 decibels per doubling of time is shown in Figure 4.1-5. The important thing to consider here is whether or not the data points define a flat curve over a range of at least 25 dB. Deviations from flatness at one end of the 25 dB range shown could be compensated for, by gain adjustments, if the curve is flat over a total of at least 25 dB.

d. Temperature Range

The response of the noise exposure meter, at high and low temperatures, relative to 100% response at 24°C, was found to be:

	Sample 1	Sample 2
5°C	106%	94%
45°C	106%	113%

e. Battery Voltage

The response of the noise exposure meter, relative to 100% response for a full-charged battery, was 75% for Sample 1 and 91% for Sample 2 at the voltage at which the battery check indicator showed battery failure.





Personal (Wearable) Instruments

4.2. Model B

Two samples were purchased but tests are reported for only one since the other was found to be defective.

4.2.1. Acoustical Tests

a. Microphone Calibration

The relative response of the microphone, based on 0 dB response at 1 kHz, is shown as a function of frequency in Figure 4.2-1. Tests over the range of A-weighted-sound levels from 90 to 115 dB indicated no problems with linearity.

b. System Response

The overall performance of the noise exposure meter, when placed in a random, diffuse sound field as described in Section 3.1.b., is shown in Figure 4.2-2. The response was measured relative to a calibrated condenser microphone and measurement system. The cross-hatched region indicates the estimated uncertainty (95 percent confidence limits) in the level of the sound field in which the noise exposure meter was tested.

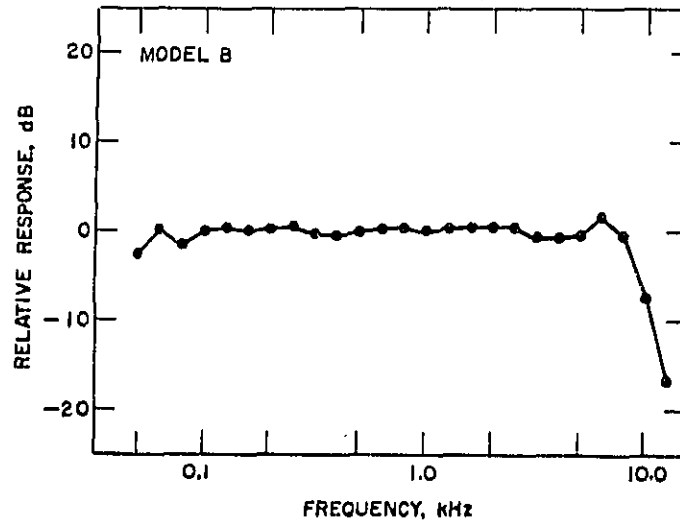

Figure 4.2-1. Relative frequency response of microphone.

4.2.2. Electrical Tests

a. Frequency Response

The combined frequency response of the microphone, the input amplifier, and the A-weighting network, as measured at the output of the A-weighting network, is shown in Figure 4.2-3. The manufacturer of this instrument has notified NBS that they have modified the design to improve the high frequency performance.

b. Crest Factor Capability

The response of the noise exposure meter, normalized to 100% for a crest factor of 1.414 (sine wave), is shown in Figure 4.2-4, as a function of the crest factor (ratio of peak voltage to rms voltage) of the test signal.

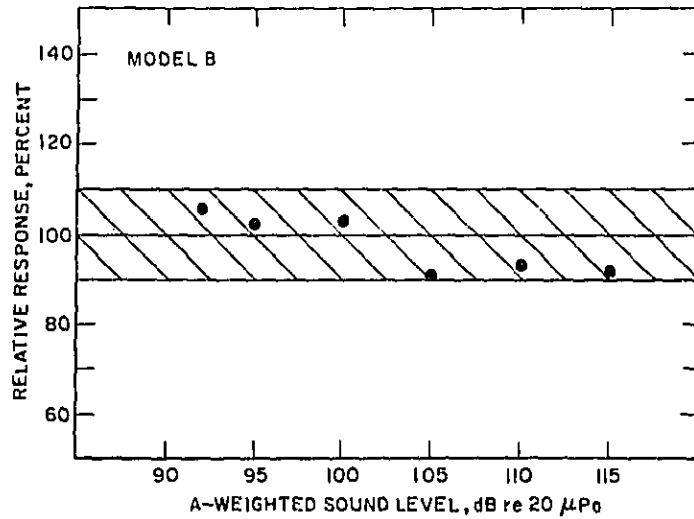

Figure 4.2-2. Response of noise exposure meter, relative to expected response, when placed in a field of pink noise (see text) at A-weighted-sound levels from 92 to 115 dB.

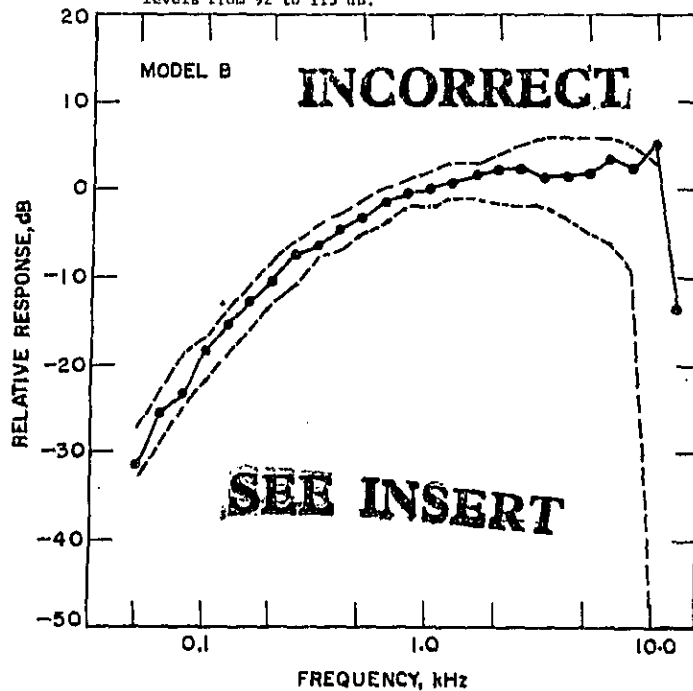

Figure 4.2-3. Relative combined frequency response of microphone plus electronics. The dashed curves indicate the allowable response level limits for a Type 2 sound level meter as specified in American National Standard Specifications for Sound Level Meters, S1.4-1971.

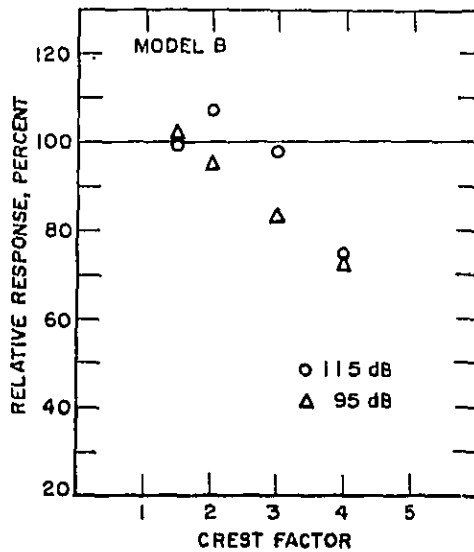

Figure 4.2-4. Response of noise exposure meter normalized to 100% for a sine wave input, as a function of crest factor.

c. Exchange Rate

The response of the noise exposure meter, normalized to 100% at a duration of 0.25 hours, relative to the response of an instrument with an exchange rate of exactly 5 decibels per doubling of time is shown in Figure 4.2-5. The important thing to consider here is whether or not the data points define a flat curve over a range of at least 25 dB. Deviations from flatness at one end of the 25 dB range shown could be compensated for, by gain adjustments, if the curve is flat over a total of at least 25 dB.

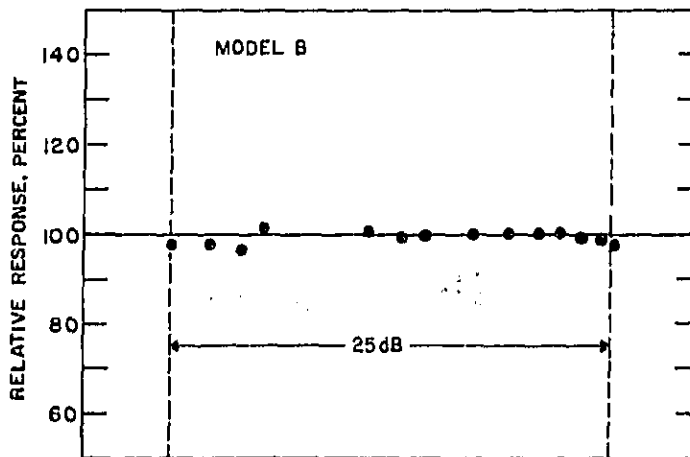

Figure 4.2-5. Relative response of noise exposure meter to an electrical signal covering a range of approximately 25 dB. See text for method of normalization.

d. Temperature Range

The response of the noise exposure meter, at high and low temperatures, relative to 100% response at 24°C, was found to be:

5°C	102%
45°C	99%

a. Battery Voltage

Operation of the battery check indicator appeared satisfactory -- as long as the light would go on, the response of the noise exposure meter did not change.

4.2.3. General Observations

a. Turning the switch from "on" to "battery check" and back to "on" was observed to advance the counter by one count (.1%).

Personal (Wearable) Instruments

4.3. Model C

Only one sample was tested.

4.3.1. Acoustical Tests

a. Microphone Calibration

The relative response of the microphone, based on 0 dB response at 1 kHz, is shown as a function of frequency in Figure 4.3-1. Tests over the range of A-weighted-sound levels from 90 to 115 dB indicated no problems with linearity.

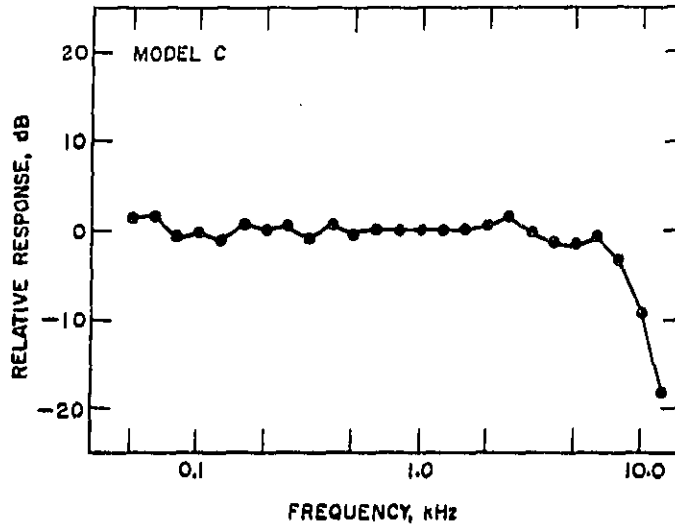

Figure 4.3-1. Relative frequency response of microphone.

b. System Response

The overall performance of the noise exposure meter, when placed in a random, diffuse sound field as described in Section 3.1.b., is shown in Figure 4.3-2. The response was measured relative to a calibrated condenser microphone and measurement system. The cross-hatched region indicates the estimated uncertainty (95 percent confidence limits) in the level of the sound field in which the noise exposure meter was tested.

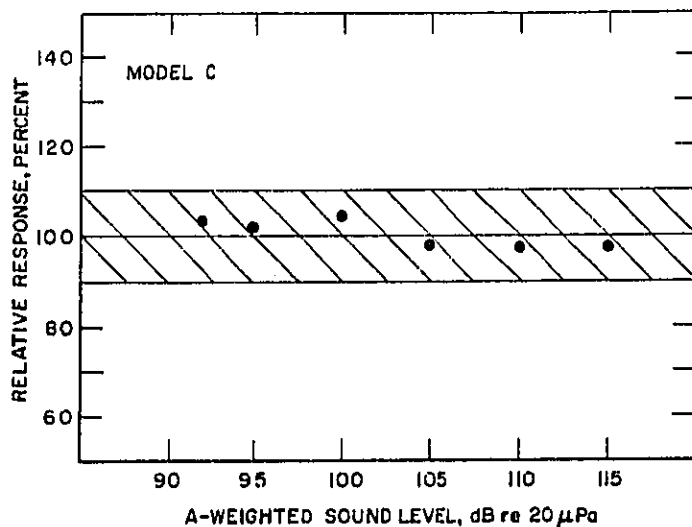

Figure 4.3-2. Response of noise exposure meter, relative to expected response, when placed in a field of pink noise (see text) at A-weighted-sound level from 92 to 115 dB.

#### 4.3.2. Electrical Tests

##### a. Frequency response

The combined frequency response of the microphone, the input amplifier, and the A-weighting network, as measured at the output of the A-weighting network, is shown in Figure 4.3-3.

##### b. Crest Factor Capability

The response of the noise exposure meter, normalized to 100% for a crest factor of 1.414 (sine wave), is shown in Figure 4.3-4, as a function of the crest factor (ratio of peak voltage to rms voltage) of the test signal.

##### c. Exchange Rate

The response of the noise exposure meter, normalized to 100% at a duration of 0.25 hours, relative to the response of an instrument with an exchange rate of exactly 5 decibels per doubling of time is shown in Figure 4.3-5. The important thing to consider here is whether or not the data points define a flat curve over a range of at least 25 dB. Deviations from flatness at one end of the 25 dB range shown could be compensated for, by gain adjustments, if the curve is flat over a total of at least 25 dB.

##### d. Temperature Range

The response of the noise exposure meter, at high and low temperatures, relative to 100% response at 24°C, was found to be:

5°C	100%
45°C	101%

##### e. Battery Voltage

This instrument did not have a battery voltage indicator.

#### 4.3.3. General Observations

(none)

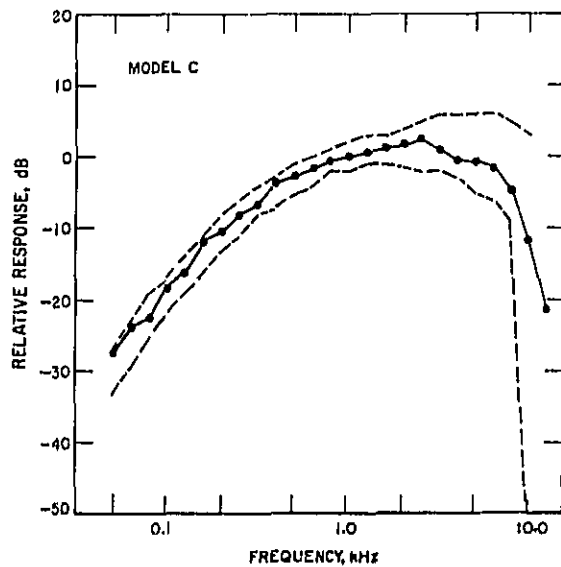

Figure 4.3-3, Relative combined frequency response of microphone plus electronics. The dashed curves indicate the allowable response level limits for a Type 2 sound level meter as specified in American National Standard Specifications for Sound Level Meters, S1.4-1971.

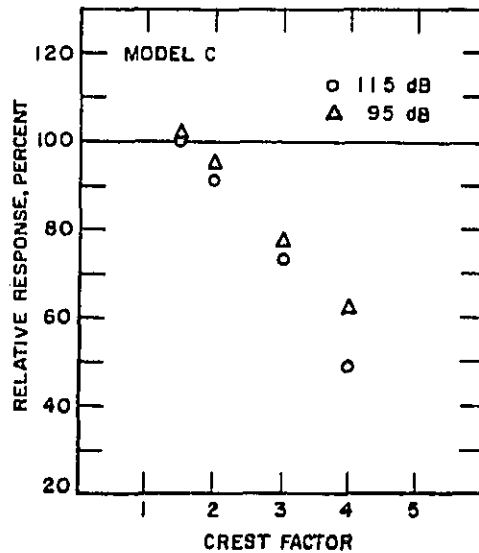

Figure 4.3-4, Response of noise exposure meter, normalized to 100% for a sine wave input as a function of crest factor.

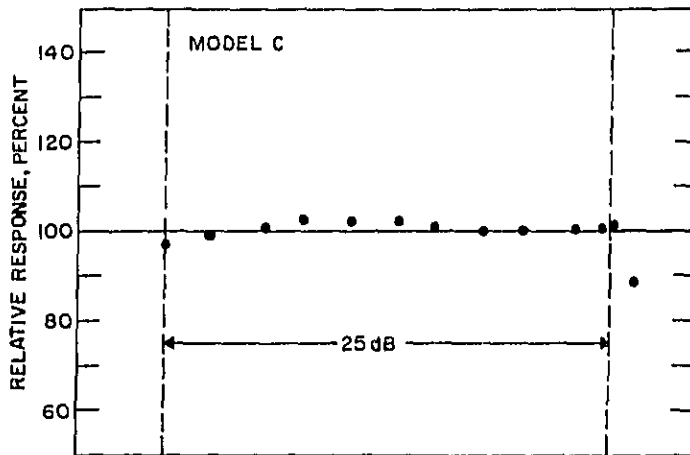

Figure 4.3-5. Relative response of noise exposure meter to an electrical signal covering a range of approximately 25 dB. See text for method of normalization.

#### Personal (Wearable) Instruments

##### 4.4. Model D

Two pilot-production samples, designated 1 and 2, were tested. The overall (acoustical) system performance of two production samples, designated 3 and 4, was determined.

##### 4.4.1. Acoustical Tests

###### a. Microphone Calibration

The relative response of the microphone, based on 0 dB response at 1 kHz, is shown as a function of frequency in Figure 4.4-1. Tests over the range of A-weighted-sound levels from 90 to 115 dB indicated no problems with linearity.

###### b. System Response

The overall performance of the noise exposure meter, when placed in a random, diffuse sound field as described in Section 3.1.b., is shown in Figure 4.4-2. The response was measured relative to a calibrated condenser microphone and measurement system. The cross-hatched region indicates the estimated uncertainty (95 percent confidence limits) in the level of the sound field in which the noise exposure meter was tested.

##### 4.4.2. Electrical Tests

###### a. Frequency Response

The combined frequency response of the microphone, the input amplifier, and the A-weighting network, as measured at the output of the A-weighting network, is shown in Figure 4.4-3.

###### b. Crest Factor Capability

The response of the noise exposure meter, normalized to 100% for a crest factor of 1.414 (sine wave), is shown in Figure 4.4-4, as a function of the crest factor (ratio of peak voltage to rms voltage) of the test signal.



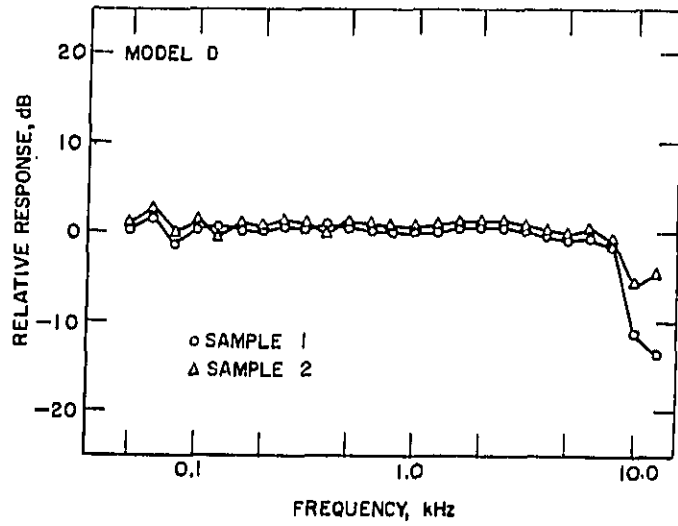

Figure 4.4-1. Relative frequency response of microphone.

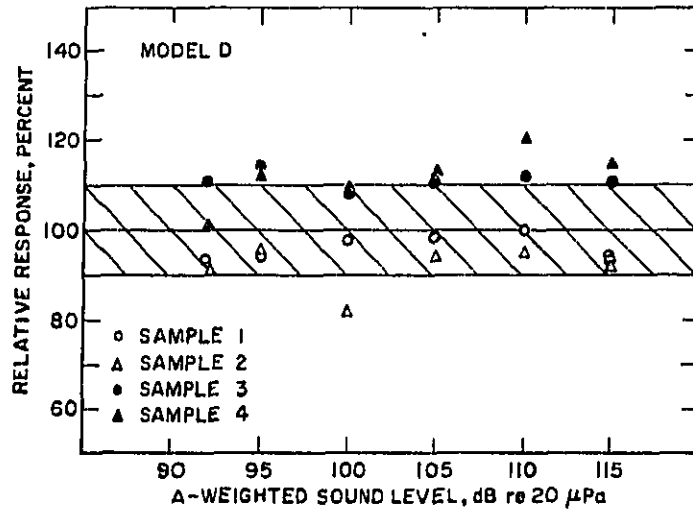

Figure 4.4-2. Response of noise exposure meter, relative to expected response, when placed in field of pink noise (see text) at A-weighted-sound levels from 92 to 115 dB.

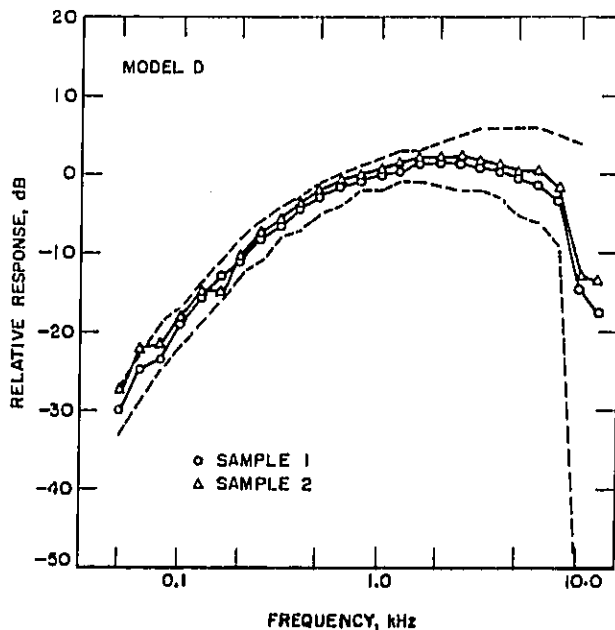

Figure 4.4-3. Relative combined frequency response of microphone plus electronics. The dashed curves indicate the allowable response level limits for a Type 2 sound level meter as specified in American National Standard Specifications for Sound Level Meters, S1.4-1971.

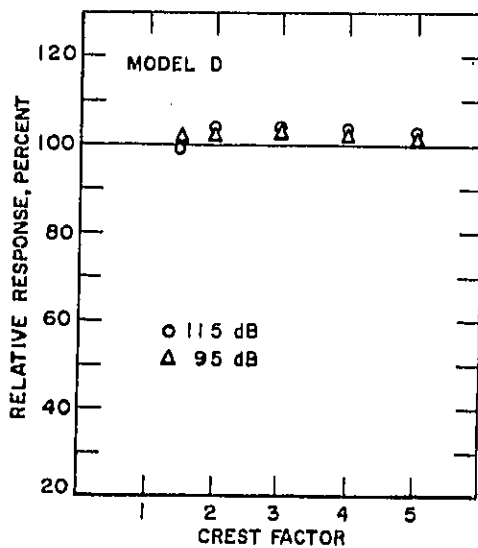

Figure 4.4-4. Response of noise exposure meter, normalized to 100% for a sine wave input, as a function of crest factor.

c. Exchange Rate

The response of the noise exposure meter, normalized to 100% at a duration of 0.25 hours, relative to the response of an instrument with an exchange rate of exactly 5 decibels per doubling of time is shown in Figure 4.4-5. The important thing to consider here is whether or not the data points define a flat curve over a range of at least 25 dB. Deviations from flatness at one end of the 25 dB range shown could be compensated for, by gain adjustments, if the curve is flat over a total of at least 25 dB.

d. Temperature Range

The response of the noise exposure meter, at high and low temperatures, relative to 100% response at 24°C, was found to be:

	Sample 1	Sample 2
5°C	-----	96%
45°C	101%	102%

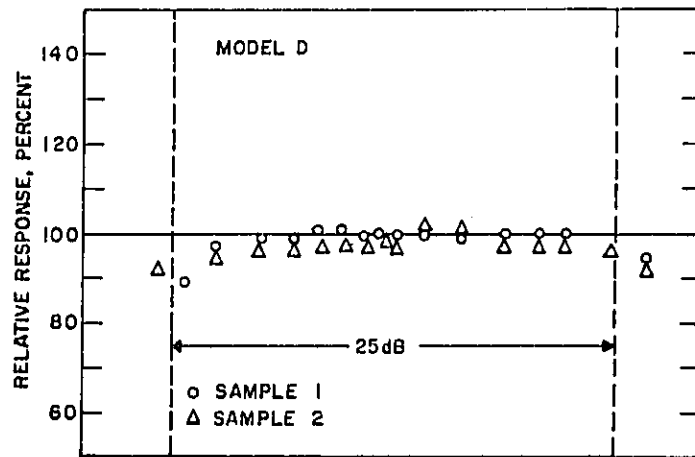

Figure 4.4-5. Relative response of noise exposure meter to an electrical signal covering a range of approximately 25 dB. See text for method of normalization.

e. Battery Voltage

Operation of the Battery check indicator appeared satisfactory.

4.4.3, General Observations

- a. It was observed that the unit can be permanently damaged during battery installation if the battery terminals are touched with reversed polarity to the connector.
- b. Difficulty was experienced in connecting the production noise exposure meters to the calibrator due to mechanical misalignment.
- c. The normal calibration check was not sufficiently precise ( $\pm 10\%$  of permissible noise exposure).

Personal (Wearable) Instruments

4.5, Model E

4.5.1 Acoustical Tests

a. Microphone Calibration

The relative response of the microphone based on 0 dB response at 1 kHz, is shown as a function of frequency in Figure 4.5-1. Tests over the range of A-weighted-sound levels from 90 to 115 dB indicated no problems with linearity.

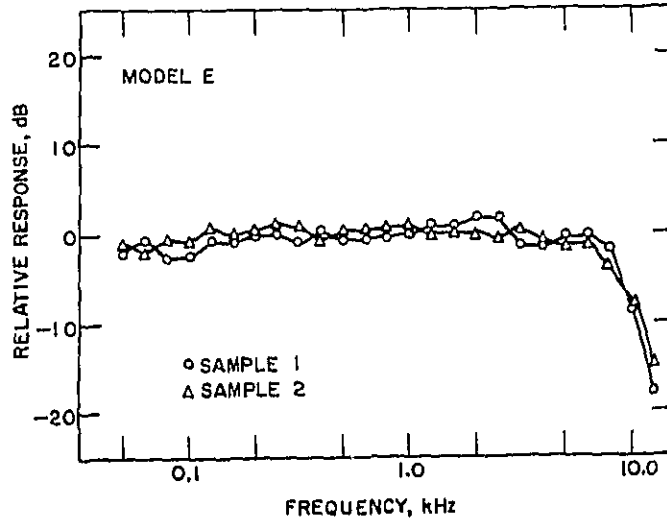

Figure 4.5-1. Relative frequency response of microphone.

b. System Response

The overall performance of the noise exposure meter, when placed in a random, diffuse sound field as described in Section 3.1.b., is shown in Figure 4.5-2. The response was measured relative to a calibrated condenser microphone and measurement system. The cross-hatched region indicates the estimated uncertainty (95 percent confidence limits) in the level of the sound field in which the noise exposure meter was tested.

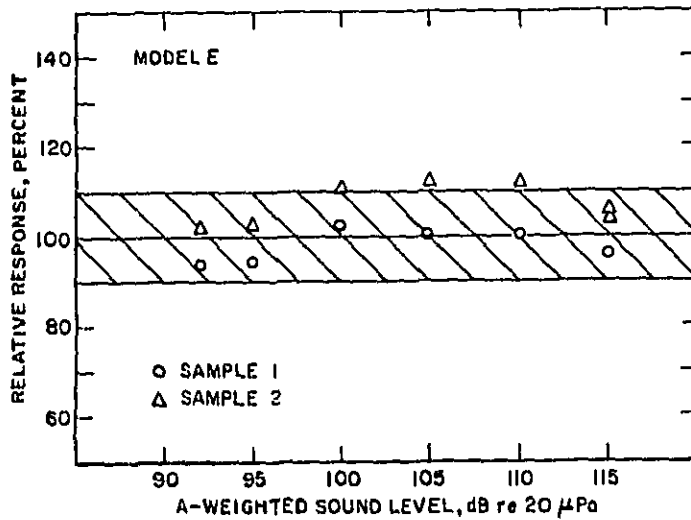

Figure 4.5-2. Response of noise exposure meter, relative to expected response, when placed in a field of pink noise (see text) at A-weighted-sound levels from 92 to 115 dB.

#### 4.5.2. Electrical Tests

##### a. Frequency Response

The combined frequency response of the microphone, the input amplifier, and the A-weighting network, as measured at the output of the A-weighting network, is shown in Figure 4.5-3. It should be noted that this unit has a potted electronics module; therefore, measurements had to be made at the output of the exchange rate circuit rather than at the output of the A-weighting network. For this reason one could only check the frequency response over a 25 dB range.

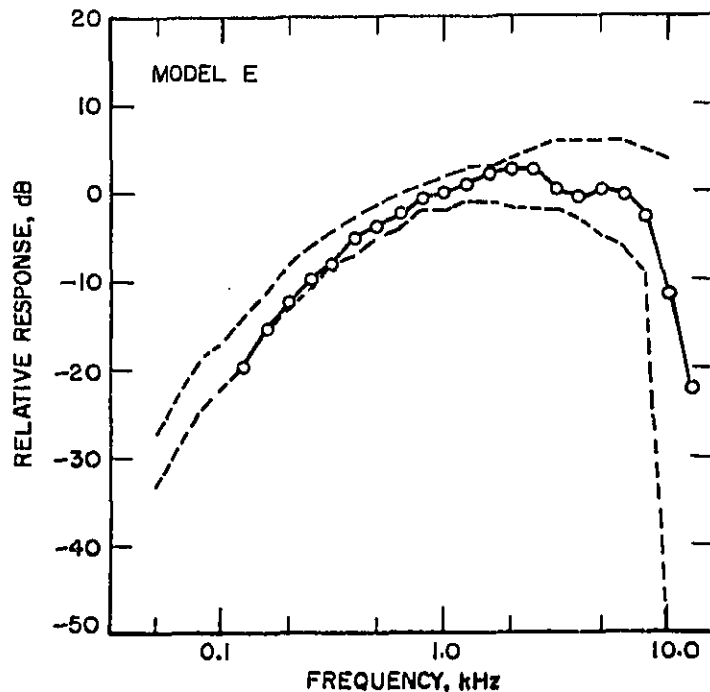

Figure 4.5-3. Relative combined frequency response of microphone plus electronics. The dashed curves indicate the allowable response level limits for a Type 2 sound level meter as specified in American National Standard Specifications for Sound Level Meters, S1.4-1971.

##### b. Crest Factor Capability

The response of the noise exposure meter, normalized to 100% for a crest factor of 1.414 (sine wave), is shown in Figure 4.5-4, as a function of the crest factor (ratio of peak voltage to rms voltage) of the test signal.

##### c. Exchange Rate

The response of the noise exposure meter, normalized to 100% at a duration of 0.25 hours, relative to the response of an instrument with an exchange rate of exactly 5 decibels per doubling of time is shown in Figure 4.5-5. The important thing to consider here is whether or not the data points define a flat curve over a range of at least 25 dB. Deviations from flatness at one end of the 25 dB range shown could be compensated for, by gain adjustments, if the curve is flat over a total of at least 25 dB.

##### d. Temperature Range

The response of the noise exposure meter, at high and low temperatures, relative to 100% response

at 24°C, was found to be:  
 5°C  
 45°C

Sample 1  
 100%  
 101%

Sample 2  
 99%  
 102%

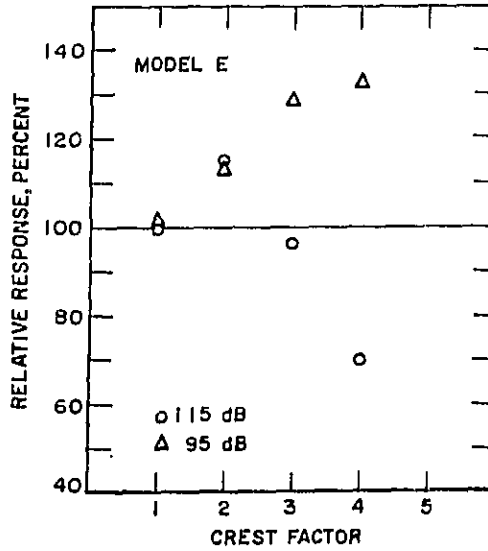

Figure 4.5-4. Response of noise exposure meter, normalized to 100% for a sine wave input, as a function of crest factor.

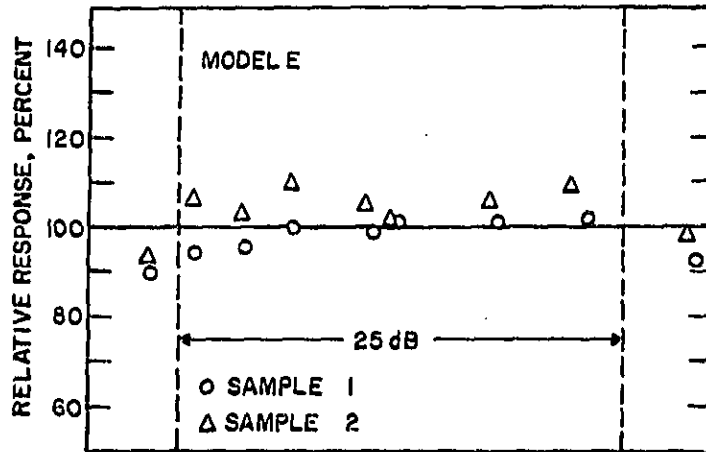

Figure 4.5-5. Relative response of noise exposure meter to an electrical signal covering a range of approximately 25 dB. See text for method of normalization.

e. Battery Voltage

The response of the noise exposure meter, on both samples, relative to 100% for a fully-

charged battery, was 94% at the voltage at which the battery check indicator showed battery failure.

#### 4.5.3. General Observations

a. The clip for attaching the microphone to the user's clothing easily became detached from the microphone.

#### Personal (Wearable) Instruments

##### 4.6. Model F

These devices were received very late in the program. Only the overall acoustical performance and the exchange rate were evaluated.

##### 4.6.1. Acoustical Tests

The overall performance of the noise exposure meter, when placed in a random diffuse sound field as described in Section 3.1.b., is shown in Figure 4.6-1. The response was measured relative to a calibrated condenser microphone and measurement system. The cross-hatched region indicates the estimated uncertainty (95 percent confidence limits) in the level of the sound field in which the noise exposure meter was tested.

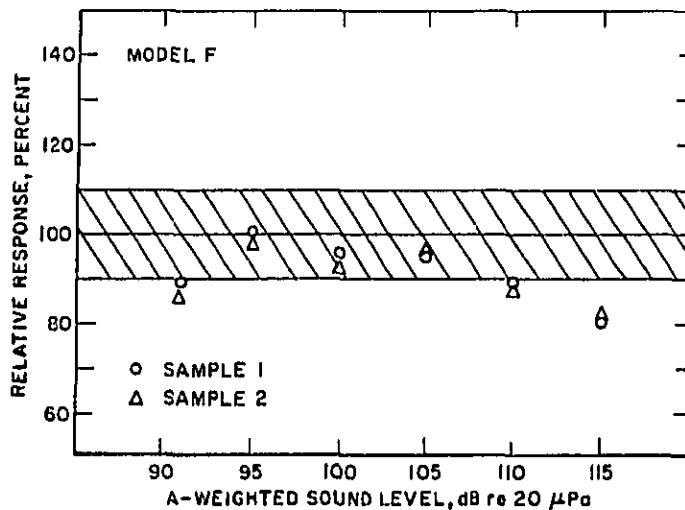

Figure 4.6-1. Response of noise exposure meter, relative to expected response when placed in a field of pink noise (see text) at A-weighted-sound levels from 92 to 115 dB.

##### 4.6.2. Electrical Tests

The response of the noise exposure meter, normalized to 100% at a duration of 0.25 hours, relative to the response of an instrument with an exchange rate of exactly 5 decibels per doubling of time is shown in Figure 5.6-2. The important thing to consider here is whether or not the data points define a flat curve over a range of at least 25 dB. Deviations from flatness at one end of the 25 dB range shown could be compensated for, by gain adjustments, if the curve is flat over a total of at least 25 dB. It should be noted that sample 2 is a first generation design while sample 1 is a later model. The manufacturer of this instrument notified NBS that they had modified the design to cover the necessary 25 dB dynamic range.

##### 4.6.3. General Observations

(none)

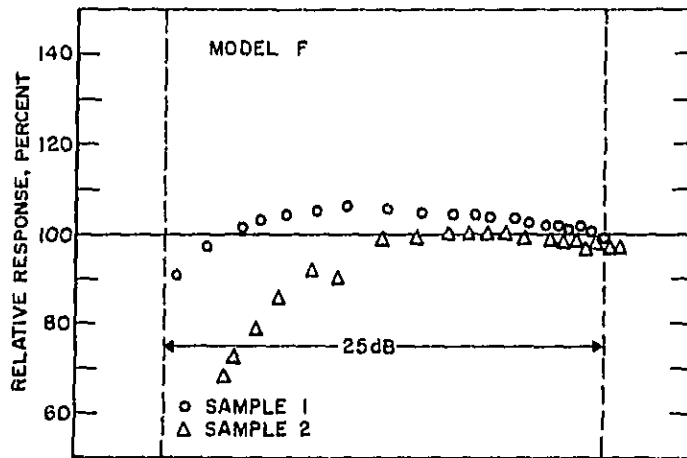

Figure 4.6-2. Relative response of noise exposure meter to an electrical signal covering a range of approximately 25 dB. See text for method of normalization.

#### Stationary Instruments

##### 4.7. Model G

This was not a personal (wearable) instrument. Only the overall (acoustical) system performance is reported.

##### 4.7.1. Acoustical Tests

The overall performance of the noise exposure meter, when placed in a random, diffuse sound field as described in Section 3.1.b., is shown in Figure 4.7-1. The response was measured relative to a calibrated condenser microphone and measurement system. The cross-hatched region indicates the estimated uncertainty (95 percent confidence limits) in the level of the sound field in which the noise exposure meter was tested.

##### 4.7.2. Electrical Tests

(none)

##### 4.7.3. General Observations

- a. The instrument counter would not advance beyond 100% exposure.

#### Stationary Instruments

##### 4.8. Model H

This was not a personal (wearable) instrument. Only the overall (acoustical) system performance is reported. One of the two samples malfunctioned so results are shown only for the other sample.

##### 4.8.1. Acoustical Tests

The overall performance of the noise exposure meter, when placed in a random, diffuse sound field as described in Section 3.1.b., is shown in Figure 4.8-1. The response was measured relative to a calibrated condenser microphone and measurement system. The cross-hatched region indicates the estimated uncertainty (95 percent confidence limits) in the level of the sound field in which the noise exposure meter was tested.



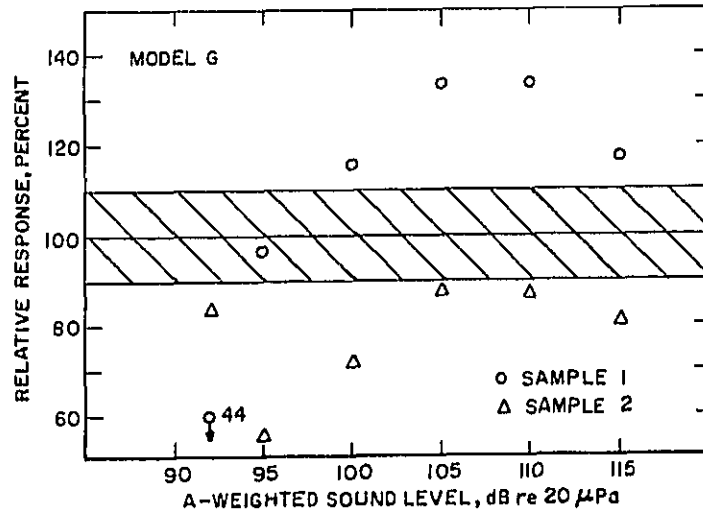

Figure 4.7-1. Response of noise exposure meter, relative to expected response, when placed in a field of pink noise (see text) at A-weighted-sound levels from 92 to 115 dB.

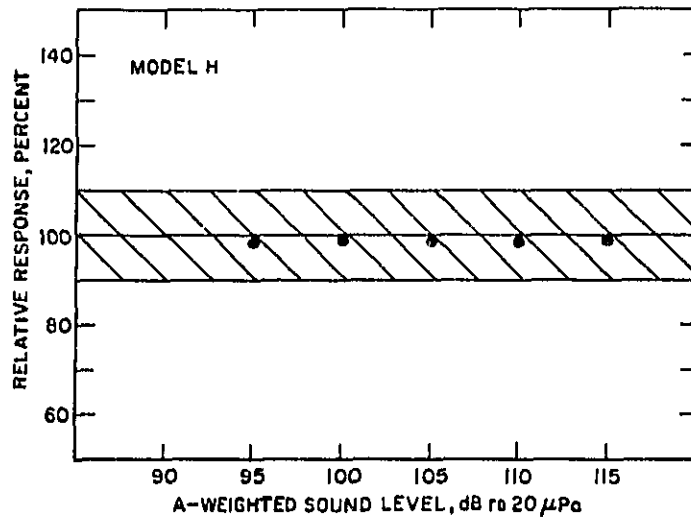

Figure 4.8-1. Response of noise exposure meter relative to expected response, when placed in a field of pink noise (see text) at A-weighted-sound levels from 92 to 115 dB.

4.8.2. Electrical Tests

(none)

4.8.3. General Observations

(none)

## 5. SUMMARY AND CONCLUSIONS

In general, the following conclusions can be drawn as a result of this test program:

- Microphone response -- Most noise exposure meters utilize well-proven ceramic microphones with characteristic response being relatively flat from 50 Hz to 5-8 kHz. None of the microphones tested showed any evidence of nonlinearities over the dynamic range of interest (90-115 dB).
- System response -- Since no performance standard exists against which these devices can be built and tested, the system responses are widely varying depending on the particular design.
- Frequency response -- Most noise exposure meters meet the allowable tolerances for a Type 2 sound level meter (relative combined frequency response of microphone plus electronics) as specified in American National Standard Specifications for Sound Level Meters, S1.4-1971.
- Crest factor capability -- Most devices can handle only small crest factors. Whether or not this presents a problem depends on the use situation. The response for all models, with the exception of model D, falls below a 90% reading or exceeds a 110% reading at a crest factor of 2-4. Model D's response remains nearly perfect at a crest factor of 4.
- Exchange rate -- The exchange rate circuitry appears to be a troublesome design problem for some manufacturers. One reason for this may be that they have no experience with such circuitry from other instruments; however, it is a crucial part of a noise exposure meter.
- Temperature range -- Most noise exposure meters suffer only a few percent error due to temperature effects over the range 5°C-45°C.
- Battery voltage -- Those devices with voltage regulation showed no effect in dosimeter reading due to battery drain effect for voltages above the battery check indicator minimum.

The obvious exception to the above general conclusions are models A and G, both of which performed poorly in each of the above tests.

It is quite evident that a comprehensive performance standard for these devices is an absolute necessity. American National Standards Institute Working Group S1-W45 is presently working on such a standard and its efforts should be encouraged and accelerated. In addition, a usage standard might be necessary to provide guidance on such items as microphone placement on the body, minimum recommended checks prior to usage, and guideline handling procedures -- important considerations which the performance standard may not provide.

The test program has shown that there exists a wide variation in performance among the various noise exposure meters tested. Some might serve as instruments for monitoring compliance with the occupational noise exposure regulation; however, the user should be cautioned to carry out enough evaluation tests to ascertain that the devices are performing adequately for his purpose.

## 6. BIBLIOGRAPHY

1. American Standard Method for the Calibration of Microphones, S1.10-1966, American National Standards Institute, New York, New York (March 1966).
2. American National Standard Specifications for Sound Level Meters, S1.4-1971, American National Standards Institute, New York, New York (April 1971).
3. International Electrotechnical Commission Recommendation on Precision Sound Level Meters, Publication 179-1965, International Electrotechnical Commission, Geneva, Switzerland (1965).
4. American National Draft Standard for Integrating Sound-Level Meters, American National Standards Institute, New York, New York.
5. Magrab, Edward B. and Blomquist, Donald S., The Measurement of Time-Varying Phenomena-Fundamentals and Applications, Wiley Interscience, New York, New York (1971).

U.S. DEPT. OF COMM. BIBLIOGRAPHIC DATA SHEET		1. PUBLICATION OR REPORT NO. NBSIR 73-417 EPA-550/9-73-007	2. Gov't Accession No.	3. Recipient's Accession No.
4. TITLE AND SUBTITLE  Evaluation of Commercial Integrating-Type Noise Exposure Meters			5. Publication Date	
			6. Performing Organization Code	
7. AUTHOR(S) William A. Leasure, Jr., Ronald L. Fisher, Marilyn A. Cadoff			8. Performing Organ. Report No. NBSIR-73-417	
9. PERFORMING ORGANIZATION NAME AND ADDRESS  NATIONAL BUREAU OF STANDARDS DEPARTMENT OF COMMERCE WASHINGTON, D.C. 20234			10. Project/Task/Work Unit No. 2130491	
			11. Contract/Grant No.	
12. Sponsoring Organization Name and Complete Address (Street, City, State, ZIP) Office Noise Abatement and Control U. S. Environmental Protection Agency Washington, D. C. 20460			13. Type of Report & Period Covered  Final	
			14. Sponsoring Agency Code	
15. SUPPLEMENTARY NOTES				
16. ABSTRACT (A 200-word or less factual summary of most significant information. If document includes a significant bibliography or literature survey, mention it here.)  As a result of the promulgation of occupational noise exposure regulations by the Federal government, there are a number of commercial noise exposure meters on the market today that provide a measure of noise integrated (with appropriate weighting) over a time interval. This report presents the results of an evaluation of such instruments by the National Bureau of Standards (under the sponsorship of the U.S. Environmental Protection Agency) as to their usefulness in monitoring compliance with occupational noise regulations as well as their applicability as instruments for use in achieving the broader goals of the EPA. Tests were designed and conducted to evaluate microphone and system response to sound of random incidence, frequency response, crest factor capability, accuracy of the exchange rate circuitry, performance of the noise exposure meter as a function of temperature, and the dependence of the device on battery voltage. The rationale of the test procedures utilized to evaluate overall system as well as specific performance attributes, details of the measurement techniques, and results obtained are discussed.				
17. KEY WORDS (six to twelve entries; alphabetical order; capitalize only the first letter of the first key word unless a proper name; separated by semicolons)  Acoustics (sound); dosimeter; environmental acoustics; instrumentation; noise exposure; noise exposure meters.				
18. AVAILABILITY		19. SECURITY CLASS (THIS REPORT)		21. NO. OF PAGES
<input checked="" type="checkbox"/> Unlimited		UNCLASSIFIED		34
<input type="checkbox"/> For Official Distribution. Do Not Release to NTIS		20. SECURITY CLASS (THIS PAGE)		22. Price
<input type="checkbox"/> Order From Sup. of Doc., U.S. Government Printing Office Washington, D.C. 20402; SD Card No. C13		UNCLASSIFIED		
<input type="checkbox"/> Order From National Technical Information Service (NTIS) Springfield, Virginia 22151				